



HAL
open science

Carabids and other beneficial arthropods in cereal crops and permanent grasslands and influence of field and landscape parameters

Damien Massaloux

► **To cite this version:**

Damien Massaloux. Carabids and other beneficial arthropods in cereal crops and permanent grasslands and influence of field and landscape parameters. Biodiversity and Ecology. AgroParisTech, 2020. English. NNT: . tel-02886480v2

HAL Id: tel-02886480

<https://agroparistech.hal.science/tel-02886480v2>

Submitted on 9 Dec 2020 (v2), last revised 25 Oct 2021 (v3)

HAL is a multi-disciplinary open access archive for the deposit and dissemination of scientific research documents, whether they are published or not. The documents may come from teaching and research institutions in France or abroad, or from public or private research centers.

L'archive ouverte pluridisciplinaire **HAL**, est destinée au dépôt et à la diffusion de documents scientifiques de niveau recherche, publiés ou non, émanant des établissements d'enseignement et de recherche français ou étrangers, des laboratoires publics ou privés.

NNT : 2020 IAVF 0012

THESE DE DOCTORAT

préparée à l'Institut des sciences et industries du vivant et de l'environnement
(AgroParisTech)

pour obtenir le grade de

Docteur de l'Institut agronomique vétérinaire et forestier de France

Spécialité : Écologie

École doctorale n°581

Agriculture, alimentation, biologie, environnement et santé (ABIES)
par

Damien MASSALOUX

Influence du paysage et de la parcelle sur les diversités de carabes et d'autres arthropodes en céréales et prairies permanentes

Directeur de thèse : **Alexander Wezel**

Co-encadrement de la thèse : **Benoit Sarrazin**

Thèse présentée et soutenue à Lyon le 22 juin 2020

Composition du jury :

M. Pierre-Henri Gouyon, Professeur, Muséum National d'Histoire Naturelle	Rapporteur
M. Marc Deconchat, Directeur de recherche, INRAE UMR DYNAFOR	Rapporteur
Mme Stéphanie Aviron, Chargée de recherche, INRAE SAD Paysage	Examinatrice
M. Davide Rizzo, Enseignant-chercheur, UniLaSalle Beauvais	Examinateur
M. Alexander Wezel, Enseignant-chercheur (HDR), Isara	Directeur de thèse

Foreword

This PhD thesis took place in the Agriculture and Environment research group Of Isara's laboratory, in Lyon, France, under the direction of Dr. Alexander Wezel and the management of Dr. Benoit Sarrazin. All the samplings and analyses were carried out in the frame of the "Ecological permeability of agricultural areas" research program, funded by the European Union through the European Regional Development Fund (reference RA RA0015616) and the Region of Auvergne Rhône-Alpes.

The aim of this program is to enhance the knowledge about the contribution of agricultural landscapes to ecological connectivity in order to formulate appropriate recommendations to land planners and farmers. Indeed, the program aims at enhancing the impact of agricultural landscapes on biodiversity.

Various research works, scientific papers and communications are directly related to this PhD thesis.

Scientific papers

Massaloux D, Sarrazin B, Roume A, Tolon V, Wezel A (2020) Complementarity of grasslands and cereal fields ensures carabid regional diversity in French farmlands. *Biodivers Conserv.* <https://doi.org/10.1007/s10531-020-02002-9>

Massaloux D, Sarrazin B, Roume A, Tolon V, Wezel A (2020) Landscape diversity and field border density enhance carabid diversity in adjacent grasslands and cereal fields. *Landsc Ecol.* <https://doi.org/10.1007/s10980-020-01063-z>

Massaloux D, Sarrazin B, Roume A, Tolon V, Wezel A (2020) Functional traits of carabid assemblages in adjacent grasslands and cereal fields. (in preparation)

Oral communications

Massaloux D, Sarrazin B, Roume A, Tolon V, Wezel A (2019). Complementarity of grasslands and cereal fields ensures carabid diversity: a study in French agricultural landscapes. In: 10th International Association of Landscape Ecology World Congress, July 1st – 5th, 2019, Milan, Italy.

Massaloux D, Sarrazin B, Roume A, Tolon V, Wezel A (2019). La complémentarité des prairies et céréales améliore la diversité des carabes. In: Rencontres d'Ecologie des Paysages 2019, November 5th-7th, 2019, Bordeaux, France.

Acknowledgement

Cette thèse, bien qu'elle porte mon nom, n'est pas le travail d'un homme seul, loin s'en faut. Vous êtes nombreux à avoir été essentiels, et sans qui elle n'existerait pas aujourd'hui.

Je remercie évidemment Alexander Wezel et Benoit Sarrazin de m'avoir accompagné tout au long de ce travail, et d'avoir su me montrer le chemin à prendre pour devenir un chercheur. Vous m'avez enseigné la rigueur et la dureté du raisonnement scientifique. Vous m'avez ainsi permis de m'épanouir dans ce métier que j'aime aujourd'hui tant.

Je remercie les membres de mon jury de thèse d'avoir accepté d'évaluer ce travail de longue haleine : les rapporteurs MM. Pierre-Henri Gouyon et Marc Deconchat, les examinateur-ices Mme Stéphanie Aviron et M. Davide Rizzo.

Je remercie aussi tout particulièrement Anthony Roume et Vincent Tolon : vous avez été d'inoubliables partenaires de travail. Que ce soit sur le terrain, entre orages et chaleurs suffocantes, ou bien devant l'âpreté d'une fenêtre de RStudio, vous avez aussi beaucoup contribué à me faire aimer la recherche, à me poser les bonnes questions et à utiliser les bons outils pour y répondre.

Je remercie Tillmann Buttschardt, Guillaume Pain, Anthony Roume et Aurélie Ferrer pour avoir accepté de faire partie de mon comité de thèse. Votre bienveillance, votre recul et vos conseils avisés ont été d'une aide inestimable pour mon avancée.

Je remercie les équipes de l'Isara, avec lesquelles cela a été une immense joie de travailler pendant ces trois années. En particulier je pense à l'équipe de potron-minet, notamment les habitués Florian, Joël, Soraya et Mathieu, Valentine et Valérie, qui m'a permis de toujours démarrer de bonne heure et de bonne humeur.

Je remercie les partenaires du projet SRCE, notamment les agriculteurs qui m'ont ouvert leur parcelle pour effectuer les échantillonnages.

Comment oublier la folle équipée de la Salade Thésard, Manon « l'Ancienne », Annabelle, Agathe, Julie « Succubus Commander », Laura « la pire », Justine « le meilleur public qui soit (tmtc) », Olivier « le père Duchêne », Mathilde, Eva, Coralie « la Guanaqueira », Alice « l'enfant terrible », Edouard et Sarah. Nous avons partagé rires et peines pendant ces mois. Une très belle page de se tourne, et vous avez été essentielles (désolé Olivier et Edouard, vous ne faites pas le poids, je mets au féminin).

Je tiens à remercier ma famille et mes amis, pour leur patience, pour avoir accepté mes absences et mon repli sur moi-même, afin de me consacrer à cette tâche. Nous allons enfin pouvoir se revoir, fantastique nouvelle n'est-ce pas ?

Cette thèse, je la dois enfin, aussi et surtout à Alix, mon épouse. Sans toi, je ne me serais pas lancé dans cette aventure de longue haleine, je n'aurais pas osé. Mais tu m'as convaincu et soutenu tout du long, tu m'as toujours dit que j'en étais capable, même dans certains moments difficiles. Cette thèse, en cela, c'est aussi un peu la tienne. Merci Amour de ma vie.

Table of contents

Foreword	iii
Acknowledgement.....	iv
Table of contents.....	vi
List of figures	xi
List of tables	xiv
1. Introduction.....	1
1.1. Intensification of agriculture and landscapes	2
1.1.1. Intensification during the European Post-War and modernization of agriculture	2
1.1.2. Intensification of agricultural practices and their impact	4
1.1.3. Intensification at landscape scale through simplification	7
1.1.4. Impacts of landscape simplification on biodiversity	9
1.2. Beneficial insects in agricultural landscapes	14
1.2.1. Ecosystem services provided by biodiversity	14
1.2.2. Landscape, ground-dwelling insects and biological control.....	14
1.2.3. Landscape, insects and pollination.....	18
1.3. Landscape functional heterogeneity.....	19
1.3.1. Limits of the fragmentation model	19
1.3.2. Landscape functional heterogeneity, an intermediate framework	21
1.3.3. Implications for biodiversity at local scale	24
1.3.4. Implications for biodiversity at the landscape scale	25
1.4. Scope of the thesis	26
1.4.1. Knowledge gaps.....	26
1.4.2. Frame of study.....	27
1.4.3. Research question and hypotheses.....	27
1.4.4. Thesis plan	29
2. Material and methods.....	31

2.1.	Study regions.....	31
2.2.	Sampling methods and protocol	34
2.3.	Statistical analyses.....	37
2.3.1.	Biodiversity indicators	37
2.3.2.	Field and landscape parameters	38
2.3.3.	Generalized linear models (GLM).....	40
2.3.4.	Mantel correlograms: spatial correlations of carabid assemblages	41
2.3.5.	Species distribution, traits and landscape context: RLQ multivariate analysis.....	41
3.	Complementarity of grasslands and cereal fields ensures carabid regional diversity in French farmlands.....	43
3.1.	Introduction.....	43
3.2.	Material and Methods.....	44
3.2.1.	Study regions	44
3.2.2.	Site selection and carabid sampling	46
3.2.3.	Data analysis.....	47
3.3.	Results	49
3.3.1.	Species richness in winter cereal and permanent grassland	49
3.3.2.	Carabid diversity: study region context and field parameters combined effects	52
3.3.3.	Spatial correlation of carabid assemblage in differentiated land covers.....	54
3.4.	Discussion	55
3.4.1.	Grassland and cereal crop carabid assemblages.....	55
3.4.2.	Similarities in carabid assemblages between cereal fields and grasslands.....	57
3.4.3.	Carabid assemblages and regional differences	57
3.4.4.	Complementarity and discrepancy of grassland and cropland in terms of carabid assemblages	58
3.5.	Conclusion	59
4	Landscape diversity and field border density enhance carabid diversity in adjacent grasslands and cereal fields	61

4.1	Introduction.....	61
4.2	Material and Methods.....	63
4.2.1	Study regions and landscape characteristics.....	63
4.2.2	Site selection and carabid sampling	64
4.2.3	Data analysis.....	65
4.3	Results	68
4.3.1	Major landscape and species differences between the three study regions.....	68
4.3.2	Gamma species richness, from both land cover types.....	70
4.3.3	Permanent grassland and winter cereal crop species richness	70
4.3.4	Common species richness	71
4.4	Discussion	72
4.4.1	Landscape diversity and edge density explain carabid species richness	73
4.4.2	Landscape parameters impact on carabid richness in grasslands but not in cereal crops	74
4.4.3	Adjacency between winter crops and grasslands drives common species richness.....	75
4.4.4	Landscape radii level explains species richness	76
4.4.5	Consistency of the landscape effect between study regions.....	76
4.4.6	The role of permanent grasslands and landscape diversity for the management of carabid species	77
4.5	Conclusion	78
5.	Functional traits of carabid assemblages in adjacent grasslands and cereal fields	79
5.1.	Introduction.....	79
5.2.	Material and Methods.....	81
5.2.1.	Study regions and landscape characteristics.....	81
5.2.2.	Site selection and carabid sampling	82
5.2.3.	Data analysis.....	83
5.3.	Results	87
5.3.1.	Life traits of common and exclusive species to paired cereal fields and grassland	87

5.3.2.	Distribution of life traits between the two land covers	88
5.3.3.	Landscape context influence on life traits.....	90
5.4.	Discussion	92
5.4.1.	Polyphagous species are more shared by both land covers	92
5.4.2.	Trait occurrence is primarily determined by the land cover type.....	92
5.4.3.	Landscape isolation endangers grassland specialists.....	94
5.5.	Conclusion	95
6.	Landscape and field parameters, spiders and pollinators.....	97
6.1.	Introduction.....	97
6.2.	Material and methods	98
6.2.1.	Study regions	98
6.2.2.	Site selection and insect sampling	99
6.2.3.	Data analysis.....	101
6.3.	Results	103
6.3.1.	Spider family richness activity-density	103
6.3.2.	Hoverfly activity-density.....	106
6.3.3.	Lacewing activity-density	107
6.4.	Discussion	108
6.4.1.	Spider family richness was not determined by landscape parameters	109
6.4.2.	Grasslands enhances the number of spiders	109
6.4.3.	Pollinators density and their landscape context	110
6.4.4.	Limits of the pollinators sampling	111
6.5.	Conclusion	112
7.	General discussion.....	113
7.1	Main results and hypotheses validation	113
7.1.1	Neighboring grassland and cereal carabid communities have species in common....	113
7.1.2	Functional traits of carabids in grasslands and cereal crops.....	114
7.1.3	Field and landscape parameters influence on other beneficial arthropods	114

7.2	Managing the landscapes for beneficial diversity conservation	115
7.2.1	A mosaic of grasslands for enhanced potential biological control.....	115
7.2.2	Taking natural enemies' dispersal ability into account	117
7.2.3	Small-scale and diversified farming as an opportunity for enhancing biological control	118
7.2.4	Complementary landscape solutions	119
7.3	Higher biodiversity may favor potential biological control.....	120
7.3.1	Complementarity of natural enemies as an asset for biological control	120
7.3.2	Higher diversity involves higher resilience of the enemy community	122
7.3.3	Limits to enhancing natural enemy diversity	122
7.4	Operational recommendations, tools and public policy	124
7.4.1	Public policies of landscape management	124
7.4.2	At the farmers' level	127
7.4.3	Applied recommendations for our study regions	128
7.4.4	Agricultural landscapes as a Common.....	129
7.5	Limits of the thesis	132
7.5.1	Some issues regarding our data collection and sampling	132
7.5.2	Differences between study regions.....	132
7.5.3	Landscape-practices interactions towards biodiversity	133
8.	Conclusion	136
	References.....	138
	Appendices	168
	Table of contents.....	168
	Résumé substantiel en français.....	187
	Abstract	201
	Résumé.....	202

List of figures

Figure 1. Evolution of (a) number of farms in France and (b) the mean farm utilized agricultural surface in France (source: Agreste, 2016).....	3
Figure 2. Landscape configurational and compositional heterogeneities (source: Fahrig et al., 2011) .	8
Figure 3. Different perceptions of the landscape according to the taxon (source: Henle and Kaule, 1991)	8
Figure 4. Evolution of the total permanent grassland area in France (source: Agreste, 2016).	10
Figure 5. Illustrated example of cyclic colonization for a carabid species which would overwinter as an adult in permanent grasslands and move back to crops in spring.....	12
Figure 6. Patch-corridor-matrix representation inherited from the fragmentation model (Source: Fischer and Lindenmayer, 2007)	20
Figure 7. Continuum model illustration (Source: Fischer and Lindenmayer, 2006).....	21
Figure 8. Illustrated effect of landscape complementation on biodiversity (Source: Fahrig et al., 2011)	23
Figure 9. Study regions locations in France and Auvergne Rhône-Alpes region.....	31
Figure 10. Photographs of the three study regions (a) Bièvre, (b) Forez and (c) Rovaltain, (d) pitfall trap and (e) flight trap in a winter cereal field.....	33
Figure 11. Paired flight and pitfall traps	35
Figure 12. Locations of sampled traps in cereal crops and permanent grasslands per study region: (a) Bièvre, (b) Forez and (c) Rovaltain.	36
Figure 13. Different landscape context radii around the pairs of sampling points.....	39
Figure 14. Preliminary PCA on landscape parameters first and second axes.	40
Figure 15. Locations of (a) the three study regions in the Auvergne Rhône-Alpes region, France, (b) sampling points (either cereal field or grassland) in the Rovaltain study region, and (c) example of sampling sites in neighboring paired cereal fields and grasslands.	46
Figure 16. Significant parameters and interactions effects of multivariate model analysis in the three study regions: (a) species richness explained by study region, (b) study region and land cover type, (c) permanent grassland and field size, and (d) evenness.	53
Figure 17. Sørensen beta diversity of cereal field and grassland in all three study regions per class of distance.	55
Figure 18. Spatial locations of (a) the three study regions in the Auvergne Rhône-Alpes region, France, (b) location of sampling points (either in cereal field or grassland) in the Rovaltain study region and (c) example of neighboring sampling location in paired cereal fields and grasslands.....	64
Figure 19. Different landscape context radii around the pairs of sampling points.....	66

Figure 20. Significant variables and interactions effects of multivariate model analyses of the gamma species richness in the three study regions and land use in the 200 m radius, explained by: (a) landscape Shannon diversity index, (b) overall edge density.	70
Figure 21. Significant interaction effect of the permanent grassland species richness and the landscape Shannon diversity index in the three study regions for the 200 m radius land use.	71
Figure 22. Significant variables and interactions effects of multivariate model analysis of the common species richness ratio in the three study regions in the 200 m radius explained by: (a) winter crop – permanent grassland edge density, (b) grassland area percentage.	72
Figure 23. Spatial locations of (a) the three study regions in the Auvergne Rhône-Alpes region, France, (b) location of sampling points (either in cereal field or grassland) in the Rovaltain study region and (c) example of neighboring sampling location in paired cereal fields and grasslands.	82
Figure 24. Different landscape context radii around the pairs of sampling points.	86
Figure 25. Species probability of commonness according to according to life traits and size: (a) diet and size, (b) wing status and size.	89
Figure 26. Species probability to be exclusive to one land cover type according to life traits and size: (a) diet and size, (b) wing status and size.	89
Figure 27. Ordination of the landscape parameters and carabid species traits along the two first axes of the RLQ analysis	91
Figure 28. Locations of (a) the three study regions in the Auvergne Rhône-Alpes region, France, (b) sampling points (either cereal field or grassland) in the Rovaltain study region, and (c) example of sampling sites in neighboring paired cereal fields and grasslands.	99
Figure 29. Paired flight and pitfall traps	100
Figure 30. Example of 500 m landscape context radius around a pair of paired fields.	102
Figure 31. Significant parameters and interactions effects of the spider family richness model analysis in the three study regions	105
Figure 32. Significant parameters and interactions effects of the spider activity-density model analysis in the three study regions: (a) sampled field size, (b) grassland coverage ^a and sampled field land cover type, (c) landscape Shannon diversity ^a and sampled field land cover type, (e) hedgerow coverage ^a and sampled field land cover type.	106
Figure 33. Significant parameters and interactions effects of the hoverfly activity-density model analysis in the three study regions: (a) grassland coverage ^a and sampled field land cover type, (b) sampled field size and land cover type, (c) grassland coverage ^a and study region, (d) edge density ^a and sampled field land cover type.	107

Figure 34. Significant parameters and interactions effects of the lacewing activity-density model analysis in the three study regions: (a) grassland coverage ^a , (b) sampled field size and land cover type, (c) hedgerow coverage ^a and sampled field land cover type.	108
Figure 35. Illustration of aphid predation complementarity between (a) the vegetational stage, with foliar dwellers, parasitoids and web spiders; and (b) the ground stage with ground dwellers.....	121
Figure 36. Social-ecological framework adapted to the management of agricultural landscapes and the provision of ecosystem services (Source: Lescouret et al., 2015)	126
Figure 37. Elinor Ostrom’s eight principles for governing the Commons (Ostrom 2015).....	131
Figure 38. Combined effects of landscape heterogeneity and farming practices on biodiversity (Source: Batáry et al., 2017)	134

List of tables

Table 1. Land cover characteristics of the three study regions in southeastern France.	32
Table 2. Parameters used to describe the sampled fields in the statistical analyses	38
Table 3. Landscape parameters included in the preliminary PCA.....	39
Table 4. Land cover characteristics of the three study regions in southeastern France.	45
Table 5. Species richness of carabid beetles in winter cereal and permanent grasslands in three agricultural areas of southeastern France.	51
Table 6. Most abundant species in (a) winter cereal crops, and (b) permanent grasslands in the three study regions of southeastern France.....	52
Table 7 Mantel correlation between permanent grasslands and cereal fields carabid assemblages. .	54
Table 8. Landscape parameters included in the preliminary PCA.....	66
Table 9. Selection of significant landscape parameters selected to analyze carabid species richness with generalized linear models comparison.	67
Table 10. Landscape characteristics in the 200 m radius area around sampling points in the three study regions.....	69
Table 11. Carabid species richness in the three different study regions.	69
Table 12. Summary of significant effect of landscape variables on carabid species richness and in relation to study regions.	73
Table 13. Carabid life traits categories used in the generalized linear mixed models (GLMm) and RLQ analyses.....	84
Table 14. Significant landscape parameters selected to analyze carabid species richness with generalized linear models comparison.	87
Table 15. Abundance of carabids in agricultural landscapes in southeastern France common or exclusive in grasslands and cropland in relation to traits: (a) diet (b) wing status and size.	88
Table 16. Land cover characteristics of the three study regions in southeastern France.	99
Table 17. Selection of significant landscape parameters selected to analyze carabid species richness with generalized linear models comparison.	103
Table 18. Diversity and activity-density of spiders in winter cereal fields and permanent grasslands in the three study regions.	104
Table 19. Distribution of the 10 most sampled spider families by land cover type and family.....	105

À mon père

1. Introduction

The global impact of human activities on biodiversity is more and more documented, leading researchers from diverse fields to refer to our current epoch as to the Anthropocene (Zalasiewicz et al. 2010; Steffen et al. 2011), a term originally forged by Nobel-rewarded Paul J. Crutzen in papers firstly published about two decades ago (Crutzen 2006; Crutzen 2016). Humans are hereby succeeding to the Holocene and therefore can be considered as a geological force through their industrial activities. Indeed, the current extinction rate of species around the globe is around 1,000 times higher than normal, undoubtedly due to anthropogenic activities (Pimm et al. 2014; Ceballos et al. 2015), leading to talk about the sixth mass extinction of the Earth life history (Dirzo et al. 2014; Ceballos and Ehrlich 2018).

Nowadays agriculture is one major threat to biodiversity, through its intensive practices and its impact on landscape (Bianchi et al. 2006; IPBES 2018a). Indeed, farming activities contribute to degrade and fragment natural habitats, causing the decline of wildlife (IPBES 2018b). As farmland occupies 70 % of Europe, it therefore substantially impacts on biodiversity. Agricultural fields are subject to recurrent and frequent disturbances, which shape the ecological communities living in agricultural landscapes (Duelli et al. 1999; Fahrig et al. 2011).

Agriculture intensification led to higher crop yields (Bowler 1986), but the need for mechanization and the specialization of agricultural regions simplified the landscapes, with the reduction of crop diversity, the enlargement of fields and the removal of natural and semi-natural areas (Benton et al. 2003; Tscharrntke et al. 2012a; Gámez-Virués et al. 2015). This pronounced human management of landscape drove to a strong simplification and has had dramatic ecological impacts (Stoate et al. 2009) and insects are among its first and major victims (Sánchez-Bayo and Wyckhuys 2019).

Among these endangered or already extinct arthropods, many are providing ecosystem services, such as biological control of pests and weeds, crop pollination, nutrient recycling or soil stabilization (Altieri 1999; Emmerson et al. 2016; Dainese et al. 2019). The whole diversity of arthropods is threatened, from ground-dwellers to flying groups. Hence, it is the whole agroecosystem sustainability which is threatened by intensive farming (Sánchez-Bayo and Wyckhuys 2019; Dainese et al. 2019).

There is a strong need to change the ways to produce food. A major concern is thereby to know how to organize and manage the agricultural landscapes in order to enhance their biodiversity, including the beneficial one, so it supports agriculture with ecosystem services and consequently also contributing to reduce the amount of synthetic inputs (Sánchez-Bayo and Wyckhuys 2019; Sirami et al. 2019).

1.1. Intensification of agriculture and landscapes

1.1.1. Intensification during the European Post-War and modernization of agriculture

Agricultural intensification describes a process in which the inputs are increased in order to obtain higher outputs (Bowler 1986). This means that, while intensifying their practices, farmers use higher amounts of fertilizers, pesticides, fungicides, herbicides, oil fuel (through mechanization), in order to get higher productivity of their work and fields, hence yields. In this part, we are going to explore how and when the agricultural intensification occurred in Europe and France, what concrete changes it had in agricultural practices, and finally, how it impacted on the rural landscapes.

In order to stabilize the global food production agriculture has known its own “Green Revolution” during the 20th century in Western countries. This modernization of agriculture followed the trends of public policies and technological advances.

In France, the modernization of agriculture occurred mainly after the World War II. The aim of its policies was to find a third way between the liberal capitalism of the United States of America and the social revolution of the Soviet Union (Allaire 1988). The aim of the modernization of agriculture was not so much to improve the living standard of the rural populations but to improve the economic situation of the system overall (Daucé 2000). The intensification of agriculture thereby occurred as the industrialization of agriculture, thus its integration in the agri-food industry, which hence meant an autonomy loss for the farmers (Allaire 1988).

More advanced farming education then aimed at teaching the farmers how to enact new techniques, such as the use of chemical fertilizers and pesticides, agronomic practices or genetic improvement (Daucé 2000). This phenomenon was even enhanced since it was funded through the Marshall Plan, which as well accelerated the mechanization of farms.

Then, the agricultural intensification aimed at providing to the French nation the highest amount of food at the lowest price, supported of course by important campaigns of public policies to help its development (Gerbaux and Muller 1984). The number of farmers decreased substantially, being selected through the processes of public policies and the granting of loans (Figure 1a). As the number of farms decreased, their mean size went higher (Figure 1b).

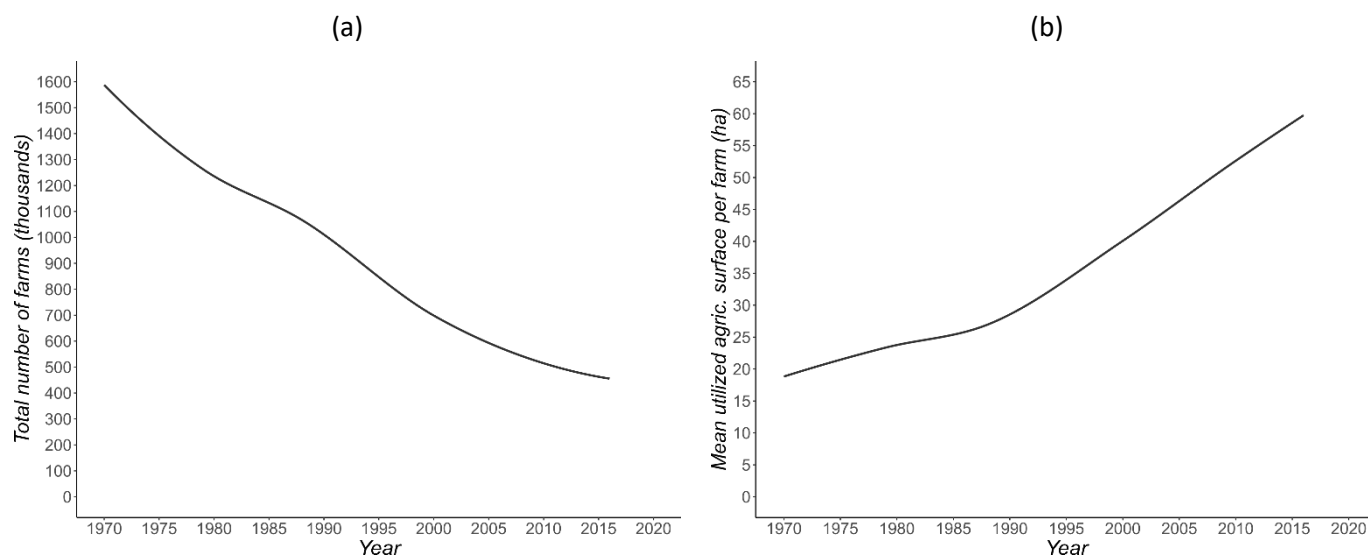

Figure 1. Evolution of (a) number of farms in France and (b) the mean farm utilized agricultural surface in France (source: Agreste, 2016).

The role of the Common Agricultural Policy (CAP) has been important in the modernization of agriculture in European Union (Emmerson et al. 2016). Indeed, the CAP first aimed at increasing the agricultural production in order to stabilize the food supply in the Post-War era, as the Treaty of Rome settled in 1957. Three protectionist mechanisms were then operated to favor the development of European agricultural production, such as the support of price, so that the producers can live from their work, high import tariffs, in order to prioritize domestic producers, and finally encourage export with proper subsidies. This risk-free environment gave agriculture a much higher profitability than before, and secured the farmers into investing in more technologically-advanced equipment and buying or renting new land for enlargement (Bowler 1986).

The intensification of agriculture also resulted in the specialization of farms and agricultural regions (Allaire 1988). Specialization can be defined as the focus of the production of a farm, region or country, towards a little diversity of products, or outputs (Bowler 1986). A specialized farm, where a narrow range of products is made, is the opposite of a diversified farm, where products of different natures are made. On one hand, the use of chemical fertilization freed the cultivators from organic fertilization, which came from livestock manure for the most (Mazoyer and Roudart 2006). On the other hand, the high availability of cheaper food for cattle, such as cereals or protein crops coming from specialized cropping farms, allowed the breeders to feed their cattle without self-sufficiency.

At some point, farmers could not avoid specialization since they concentrated their capital investments in new equipment, which was specialized itself: for example, croppers bought larger tractors and combine harvesters whereas dairy farms got milking machines. Economies of scale then drove farmers to orient their production towards the more profitable activity (Bowler 1986). Agri-food industry then

developed according to the comparative advantages of every region. In Europe, this regional specialization can be observed at the country level, e.g. with France and United Kingdom showing focus towards cereal production, and Netherlands and Ireland having increased their dairy production. Specialization is also observed at the regional scales of countries: in France, intensive livestock for meat production has developed in Brittany, while Normandy focused on grass-based dairy production, northern regions are important producers of sugar beet and potatoes, and mountain areas are oriented towards extensive livestock (Bowler 1986). This organization is even more pronounced nowadays, where specialization is organized at a global scale. For example, the protein crops which feed European cattle, such as soybean, are massively imported from the United States of America and South America. This specialization therefore contributed to develop the agri-food industry at the mass consumption era.

Since agriculture now occupies 70 % of Europe's lands, and 59 % of France (Desriers 2007), it has strong impacts on biodiversity and its practices rule on wildlife (Hails 2002). This impact is now so considerable that it questions the sustainability of farmed ecosystems, hence the sustainability of food production (Stoate et al. 2001).

Despite a few authors already observing and informing about the decline of biodiversity due to the intensification of agriculture (Carson 1962; Dorst 1965), western countries stayed on the path of industrialization, leading the food production towards productivity and competition on global markets. Indeed, clear patterns relate agricultural intensification to the decline of farmland biodiversity since 1950's Green Revolution (Chamberlain et al. 2000; Robinson and Sutherland 2002; Emmerson et al. 2016). This loss can be linked both to farming practices and landscape simplification (Matson et al. 1997; Stoate et al. 2001; Butler et al. 2007; Stoate et al. 2009).

1.1.2. Intensification of agricultural practices and their impact

Intensification of agriculture happened at the farm and landscape levels (Emmerson et al. 2016). Agricultural practices are highly dependent on the context they are used in. A practice can be optimal in one context though it is only mismanagement in another situation (Strijker 2005). Meeting the needs of high yield varieties requested new management practices (Robertson and Swinton 2005). Therefore, farmers relied increasingly on higher inputs of pesticides, herbicides, fungicides or synthetic fertilizers. The raw productivity of every farm worker has thus been enhanced a hundredfold, since the beginning of 1950's (Mazoyer and Roudart 2006). The main objective of intensification has been to increase strongly the farming productivity.

Mechanization has been one of the most obvious form of the practice intensification, and was first the replacement of animal power by fossil fuel power in tractors (Mazoyer and Roudart 2006). Then, mechanization took a central place in the farming activities and outdated all other form of work (Binswanger 1986). Newer tractors became more and more powerful: nowadays engines are more than 10 times more powerful those from the 1950's. Progressively, new farming activities were mechanized, with for example the expansion of the combine harvester. Breeding also knew its mechanization, with the use for example of milking machines. The impact of mechanization on productivity is substantial, since the average area per worker rose from 1 ha before the 1950's to 200 ha nowadays.

One important step in the intensification in agriculture has been the selection of high yielding varieties. In order to meet the needs of newly selected varieties, the use of chemical or mineral fertilizers appeared more efficient than organic ones. The development of the extraction and the proceeding industry increased dramatically the availability of mineral fertilizers. (Mazoyer and Roudart 2006). The application of mineral fertilizers played a major role in the growth of yields (Strijker 2005). Since the beginning of the twentieth century, the wheat yields have indeed been multiplied by 7, while the nitrogen fertilization has doubled.

The intensification increased the cropping costs by capital amortization, since important amounts is invested in the seeds of selected varieties, in the depreciation of mechanized equipment or in the necessary mineral fertilization. Hence, farmers had to take as little risk as possible and secure the higher yield they can. The preventive and curative sprayings of pesticides, herbicides and fungicides thus become systematic in order to avoid the losses due to insects, weeds or disease.

1.1.2.1. Tillage

Tillage, as a pre-sowing mechanical weed control, can be considered as an intensive practice only when its depth is around 30 cm. In this case, it shall be named conventional, intensive or traditional tillage, as opposed to more modern tillage, such as the superficial and agronomic ones. Anyhow, it still concerns a high share of cropped lands across Europe, we shall study its effects on biodiversity as an intensive practice.

Tillage has a major impact on soil biodiversity, and cannot be neglected for agroecosystems (Giller et al. 1997; Kladvko 2001; Stoate et al. 2001). Tillage impacts not only on below ground, but also on ground-dwelling arthropod populations. Indeed, carabids can be exposed to predation or desiccation, physically hurt or even buried (Holland and Reynolds 2003). Moreover, the burying of crop residues by tillage reduces the diversity of saprophytic fauna, on which carabids could prey after the harvest (Hatten et al. 2007). It also simplifies the habitat of epigeal fauna, leaving less refuges against predation

or abiotic changes. Finally, deeper tillage can induce higher mortality in carabid communities than more superficial tillage (chisel plowing) or no-till at all (Shearin et al. 2007).

1.1.2.1. Crop fertilization

The application of fertilizers has importantly augmented during the Green Revolution. The input of mineral nitrogen and phosphorus fertilization has multiple ecological effects. The deposition or leaking of fertilizers on the vegetative boundaries of cropped fields benefits the most opportunistic species: the nitrophilous annual weed species (Boatman et al. 1994; Marshall and Moonen 2002). This results in the modification of the plant composition of the edges. Indeed, the more a field is managed intensively, the more it tends to homogenize the plant community in its vicinity towards more weed species (Boutin and Jobin 1998; Willi et al. 2005). Furthermore, a reduction of the botanical diversity of grassy field margins and surroundings leads to a lower diversity in gamma arthropod community (Thomas and Marshall 1999; Bengtsson et al. 2005; Guerrero et al. 2010). Intensive mineral fertilization is also thought to contribute to the decline of butterfly and bee diversity through the reduction of floral diversity (Maes and Dyck 2005; Le Féon et al. 2010).

1.1.2.2. Pest and weed control

Overall, pesticides have a negative effect on biodiversity. This impact has been found consistently all across Europe (Geiger et al. 2010; Emmerson et al. 2016). Geiger et al. (2010) found persistent declines of diversity among plant species due to herbicides and insecticides, carabid species due to insecticides and bird species due to fungicide applications. In intensively farmed areas, the reduction of botanical diversity due to herbicides has a negative impact on weed eating arthropods diversity (Clough et al. 2007). The danger of neonicotinoids on bees has also been assessed and shown (Goulson 2014; van der Sluijs et al. 2015; Kessler et al. 2015).

Moreover, pesticides can involve contamination at large spatial scales due to the drift of active substances across landscape (Gove et al. 2007; Tuck et al. 2014). This impacts on mobile species such as butterflies, bees and birds, by affecting not only the species, but the whole food web (Donald et al. 2000; Chamberlain et al. 2000; Benton et al. 2002; Emmerson et al. 2016). For example, organic farming with no herbicides conserves or augments the floral diversity which favors bumblebee diversity, even in a intensively farmed landscape context (Rundlöf et al. 2008). If we consider the bird diversity, higher insecticide applications lead to a reduction of the richness and abundance of arthropods in the whole landscape, and thus reduce the food availability of predatory arthropods, such as carabids or spiders, and birds, hence reducing their diversity (Benton et al. 2002; Hallmann et al. 2014). Finally, higher insecticide applications tend to homogenize bird communities towards the dominance of generalist species over specialists (Chiron et al. 2014).

1.1.3. Intensification at landscape scale through simplification

Before heading to the description of a landscape, it is important to start with the notion of landscape. Indeed, while the landscape can be intuitively imagined in everyone's mind. Turner and Gardner (2015) suggest: "A landscape is an area that is spatially heterogeneous in at least one factor of interest."

This wide definition deserves to open the definition of the landscape, particularly to the notion of scales, which can be of great interest for ecology. Indeed, different taxa have different perceptions of a landscape; hence, what is a landscape for a peculiar taxon, is only a habitat patch for a taxon whose mobility is wider. This definition is more practical related to this thesis than the one of the European Landscape Convention (Déjeant-Pons 2006) : "Landscape means an area, as perceived by people, whose character is the result of the action and interaction of natural and/or human factors."

We can observe here the common differences between the landscape definitions of the American and European schools of landscape ecology. Although the American school focuses on the natural value of a landscape, i.e. its fundamental biotic and abiotic components, the European school is more concerned about the interactions between the ecological and anthropogenic processes. Both perceptions are of interest related to this thesis. Indeed, there is a need of a definition which can fit various scales of ecological interpretations, and another one which can reintegrate the ecological landscape in its anthropogenic use background. This is particularly important for agricultural landscapes.

1.1.3.1. Landscape heterogeneity: composition and configuration

Landscapes can be defined through two kinds of heterogeneities: compositional and configurational (Fahrig et al. 2011), sometimes more simply brought as composition and configuration (Figure 2). Though Duelli (1997) refers to habitat diversity and heterogeneity, the notions are quite similar. The compositional heterogeneity of a landscape is its number of different land cover types. In agricultural landscapes, it will be reflected by the diversity of crops and non-cropped covers, such as grazed grasslands, hedgerows or woody groves. Compositional heterogeneity can although be weighed by the relative area covered by every of its land cover type, the same way the notion of evenness is applied to biodiversity. It is indeed the kind of ponderation made by the Shannon diversity index with biodiversity, though it is now commonly applied to landscape compositional heterogeneity as well.

Configurational heterogeneity refers to the spatial arrangement of cover types in the landscape (Fahrig et al. 2011). The configurational heterogeneity is thus measured by indicators referring to the geometric patterns and shapes of the patches in the landscape, some of the most basic being the mean patch size or the edge density. The notion of patch is then important, and can be defined as the continuous and homogeneous area

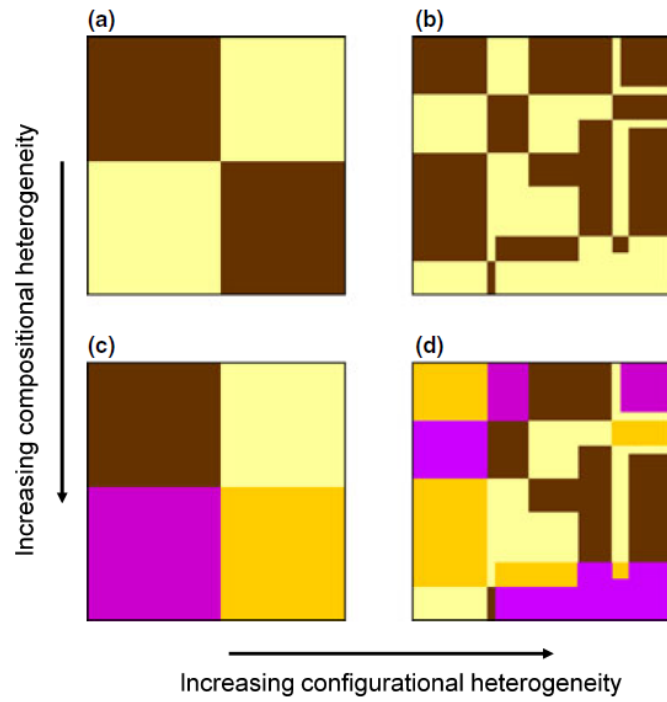

Figure 2. Landscape configurational and compositional heterogeneities (source: Fahrig et al., 2011)

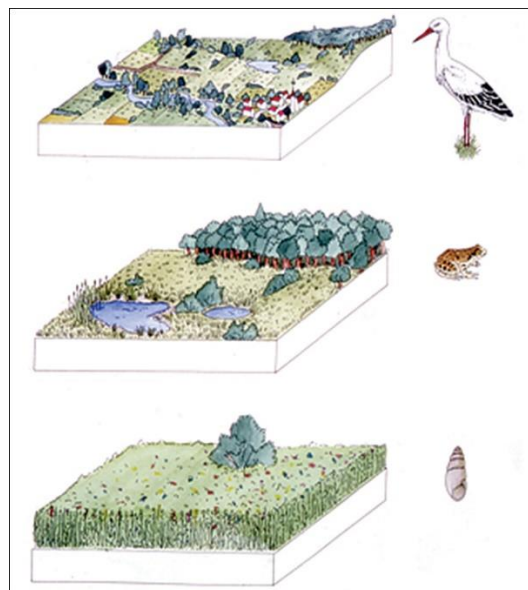

Figure 3. Different perceptions of the landscape according to the taxon (source: Henle and Kaule, 1991)

The notion of scale then appears important, as another dimension of landscape, as a research object (Bailey et al. 2007). Scale itself is defined by two parameters: grain and extent (Turner and Gardner 2015). The grain corresponds to our smallest spatial resolution; the extent is the size of the study area. The grain and extent are crucial and shall be different considering the study of various living organisms, since their perception of the landscape is different. The notions of homogeneity or the grain of a patch are not the same when we consider the dispersion ability and the mobility of different taxa (Figure 3).

1.1.3.2. Agricultural landscape simplification

Intensification of agriculture led to the reduction of crop diversity, the cropping or the abandonment of former grasslands and the removal of semi-natural elements, such as grassy strips, hedgerows or woody groves. This translates in the crude reduction of landscape compositional heterogeneity. By enlarging the field sizes, and thus regrouping them, landscape configurational heterogeneity has also been reduced through agricultural intensification. The regional specialization of agriculture homogenized the landscapes on a regional basis. Indeed, the focus on some specific productions has driven to the dominance of a low variety of them in the landscape. Both configurational and compositional heterogeneities were reduced in agricultural landscapes by the intensification of the Green Revolution. Hence, it is commonly admitted that the agricultural intensification led to the simplification of rural landscapes, as observed across Europe (Robinson and Sutherland 2002; Tschardt et al. 2005a; Emmerson et al. 2016). The simplification of agricultural landscapes can also be considered in a temporal scale with the shortening and simplification of rotations.

1.1.4. Impacts of landscape simplification on biodiversity

The intensification of agricultural practices impacted on the landscapes in various ways. The development of crop specialization of some agricultural regions has been a major driver in the modification of rural landscapes. In crop dominated regions, lots of grasslands were turned into cropland, since the breeding activities were abandoned little by little (Strijker 2005). In Europe, the decline of permanent grasslands represents 30 % of the areas they covered in 1960 (Peyraud et al. 2012). In France, this resulted in the loss of 3 million ha of permanent grasslands, which is 23 % of the areas they covered in 1970 (Huyghe 2009). However, the decline of grasslands also affected agricultural regions specialized in livestock breeding, since some of them were replaced with silage maize. Whereas it was almost absent in 1965, it now represents 83 % of the 1.7 Million ha of annual forage crops. Sown grassland areas saw an important decline, falling from 3 Million ha in 1960 to less than 0.5 Million ha in 2005.

During the agricultural intensification, the specialization of farms in cropping led to a radical reduction of crop diversity: nowadays, only three crops (wheat, maize and rice) produce 57 % of the global energetic food bowl, if we add soybean, it is 64 % of the global calories production (Ray et al. 2012). This reduction of crop diversity is also observed at the genetic level among the cultivars of a same species (Roussel et al. 2005; van de Wouw et al. 2010; Peres 2016). Hence, this resulted in homogenization of crops with shorter and simpler rotations (Stoate et al. 2001; Pointereau and Bisault 2006; Mudgal et al. 2010), whose more acute example is mono-cropping, due to the extension of cash-crop and mechanization.

Mechanization has also led to the enlargement of fields, in order to make them more practical for agricultural machines and benefit from downscaling economies. This was also the consequence of the enlargement of farms and the reduction of their number, when more productive farms assimilated smallest and less competitive ones (Stoate et al. 2001). In France, it took the form of a public policy: the reparcelling (*remembrement*). Multiple reparcelling rounds occurred between 1945 and the 2000ies (Philippe and Polombo 2009). The objective of this policy is explicitly to ease the agricultural work by combining parcels. It resulted in the increase of the average cropped parcel size.

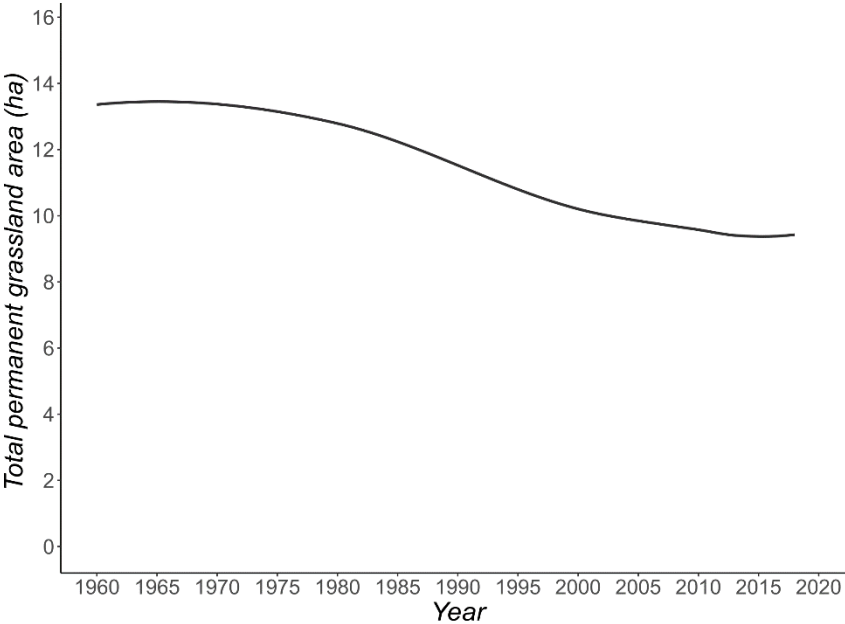

Figure 4. Evolution of the total permanent grassland area in France (source: Agreste, 2016).

The enlargement of parcels resulted in the decline of hedgerows and other semi-natural linear elements (Husson and Marochini 1997; Marshall et al. 2001; Pointereau 2002). Since they were on the boundaries between fields to be merged, they were removed and assimilated in the cropped enlarged parcels. Furthermore, woody groves were also cut down and turned into cropland. Finally, agricultural intensification led to the abandonment of former farmlands (Stoate et al. 2001). Thereby, grasslands

were cropped or abandoned (Figure 4). Parcels which could not be mechanized or which did not take part into reparable policies. The abandoned fields then get encroached by shrubs.

1.1.4.1. Composition and configuration

Landscape configurational heterogeneity benefits biodiversity (Fahrig et al. 2015). Batáry et al. (2017) indeed compared agricultural landscapes formerly separated by the Iron Curtain through central Germany: eastern landscapes had been simplified with the reparable and removal of hedgerows, whereas these changes did not occur in the West. They found higher plant and ground-dwelling arthropod diversity in western small-scaled landscapes, with higher edge density and smaller fields, than in eastern large-scaled ones, independently from farming practices intensity. The beneficial effect of smaller field size is consistent with other studies (Sirami et al. 2019).

Compositional heterogeneity also favors biodiversity at multiple trophic levels: plants, carabids, spiders, bees, hoverflies, butterflies and birds (Devictor and Jiguet 2007; Sirami et al. 2019). In agricultural landscapes, compositional heterogeneity is highly linked to the crop diversity. Indeed, increasing the number of crop types in the landscape enhances biodiversity by varying the food resource and promoting different specialist species (Sirami et al. 2019). This result emphasizes the fact that both landscape and field heterogeneities need to be taken into consideration to enhance biodiversity. Moreover, the beneficial effect of crop diversity is stronger when it is paired with a higher semi-natural coverage: this gives evidence that crop diversity provides a continuous food resource (Schellhorn et al. 2015), while semi-natural covers are both stable habitats for food and shelter (Schneider et al. 2016; Duflot et al. 2017; Gallé et al. 2018a) .

The temporal crop diversity, i.e. rotation variety and length, benefits biodiversity (Stoate et al. 2001). This is the case for carabids, whose diversity is enhanced by compositional and configurational heterogeneities (Billeter et al. 2008; Fahrig et al. 2015) as well as spatiotemporal (Bertrand et al. 2016). Indeed, different crops offer a variety and continuity of food and habitat resource for non-pest species, though they can also host pest species (Benton et al. 2002).

1.1.4.2. Grasslands and semi-natural elements: essential factors of diversity

Non-cropped habitats favor a higher biodiversity, including natural enemies, such as carabids, rove beetles, hoverflies and spiders (Dauber et al. 2005; Purtauf et al. 2005; Bianchi et al. 2006; Sirami et al. 2019) as well as pollinators (Weibull et al. 2000; Barbaro and Halder 2009). Grassy-crop adjacencies have been pointed out to enhance carabid diversity (Duflot et al. 2017). Indeed, semi-natural habitats provide alternative hosts and preys to natural enemies, or floral food resource to adult pollinators whose larvae are natural enemies, such as hoverflies or chrysopids. Finally, semi-natural habitats can

be over-wintering refuges for natural enemies (Thorbeck and Bilde 2004; Schirmel et al. 2016). It has been shown that natural enemies which overwintered in neighboring semi-natural habitats spill over back into the croplands in spring and are effective to struggle against pests (Bianchi et al. 2006). This migration of natural enemies between cropland to more stable semi-natural habitats is included in the process of “cyclic colonization pattern” (Duelli et al. 1990; Wissinger 1997; Lee et al. 2001a) (Figure 5). Semi-natural covers, such as grass strips, can also shelter carabids and protect them from insecticide sprays, then improving the biological control (Lee et al. 2001a).

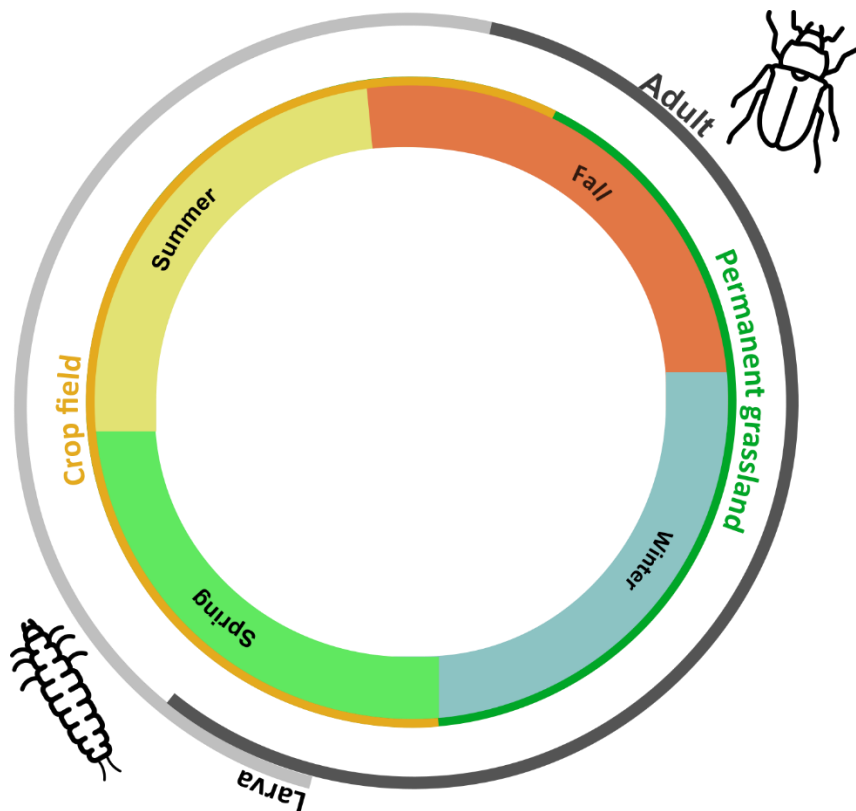

Figure 5. Illustrated example of cyclic colonization for a carabid species which would overwinter as an adult in permanent grasslands and move back to crops in spring.

Concerning grasslands, extensive grazing is associated with higher diversity of insects (Kruess and Tscharntke 2002; Grandchamp et al. 2005; Lyons et al. 2017). In European agroecosystems, since there is no consensus on the depletion of intensive grazing depletes the vegetal diversity of grasslands, this lower insect diversity is attributed to the depletion of the food availability. Populations of low abundance or of small dispersal abilities are more affected, since they are likely to move to neighboring habitats (Kruess and Tscharntke 2002).

Furthermore, ungrazed grasslands host higher insect diversity, though not higher plant diversity. The vegetational resource being higher is thereby architecturally more complex and enhances insect

richness and abundance. When eventually mowed, sequential cuts of smaller areas depletes less carabid diversity (Cizek et al. 2012). Since they imply different disturbance in time and space, associated with diverging habitat heterogeneity, grazing and mowing lead to different carabid communities (Grandchamp et al. 2005). Other studies point out the decreasing diversity of carabids in abandoned grasslands (Schirmel et al. 2015). The impact of landscape on permanent grasslands carabids has been lowly investigated.

Permanent grasslands are high quality habitats for pollinators since they offer wide range of food resource with floral diversity as well as nesting sites (Steffan-Dewenter et al. 2002; Le Féon et al. 2010). Moreover, intensive grazing pressure is detrimental to bee communities and diversity.

There is no mystery whether the species with higher conservation preoccupation are those related to grasslands and shrublands (Duelli and Obrist 2003a; Barbaro and Halder 2009), emphasizing the decline of these habitats in agricultural landscapes.

1.1.4.3. Other semi natural elements: hedgerows, grass strips and woodlands

Most linear semi-natural elements, be they hedgerows or grass strips, are located on field margins (Marshall and Moonen 2002). Being the ecotone between two habitats, the margins are ecologically richer than the areas they separate (Kovář 1992), resulting from the mixture of the diversities of both habitats as well as species which are particular to the margin . Linear semi-natural elements are refuges for farmland wildlife, including plants (Thomas and Marshall 1999; Marshall et al. 2001; Marshall and Moonen 2002). They can be forage resource for pollinators, with floral and insect diversities being related (Thomas and Marshall 1999), or shelter habitats for natural enemies (Thomas et al. 1994; Marshall and Moonen 2002).

Hedgerows are forage resource for pollinators with the additional plant diversity they bring to the landscape (Morandin and Kremen 2013; Sardiñas and Kremen 2015). Furthermore, more complex hedgerows, meaning with higher plant richness and more architectural stages, support more diverse pollinators species (Garratt et al. 2017). Higher floral diversity can thereby provide food resource continuously to pollinators. Higher abundance of pollinators is found on hedgerows in intensive landscape context, meaning that these linear elements are important food provisions in simple landscapes. This indicates that hedgerows can support the preservation of pollinators communities in intensively farmed contexts (Morandin et al. 2016; Garratt et al. 2017).

1.2. Beneficial insects in agricultural landscapes

1.2.1. Ecosystem services provided by biodiversity

In order to be sustainable, agriculture needs to rely and use ecosystem services provided by biodiversity, like biological control of pests and weeds, crop pollination, nutrient recycling or soil stabilization (Altieri 1999; Moonen and Bàrberi 2008; Emmerson et al. 2016). The species supporting these services are referred to as functional, or beneficial, (bio)diversity. The modification of ecosystems by agricultural intensification impacts on the beneficial species, hence endangering the ecosystem services they provide (Altieri 1999; Tscharntke et al. 2005a). As we could see above, species composition of agricultural landscapes is highly determined by the intensity of farming practices and habitat quality as well as spatial organization (Moonen and Bàrberi 2008). Hence it is possible to organize the agricultural landscape in order to favor species with traits which are considered beneficial for farming activities.

We will focus on the two ecosystem services provided by above-ground insects, biological control through pest predation, and pollination, and see how the landscape impacts on them.

1.2.2. Landscape, ground-dwelling insects and biological control

Populations of all species are controlled by interactions with other organisms, such as predators, parasites or diseases: this is natural control (Hajek and Eilenberg 2018). Biological control is the application of natural control to benefit farming activities through the use of living organisms to reduce pest populations. It is exploited by humans in farming activities in order to reduce the pests' damages to crops and increase the yields. Biological control can be used against all kinds of pests, including invertebrates and weeds.

Since the Green revolution, the systematic answer to pests and weeds has been through chemical or mechanical methods, though there is a need for economically viable as well as environmentally sustainable alternatives. Indeed, the use of chemical pest control raised more and more side-effect issues about human health and ecological impacts (Hajek and Eilenberg 2018). Many above-ground insect species can provide biological control in croplands, among which carabids and spiders have been highly investigated (Kromp 1999; Sunderland and Samu 2000; Nyffeler and Sunderland 2003; Bianchi et al. 2006).

Landscape heterogeneity, considering both compositional and configurational aspects, enhances ecosystem services of biodiversity towards agriculture (Bianchi et al. 2006; Emmerson et al. 2016).

Biological control is enhanced by higher landscape complexity (Rusch et al. 2013b; Lindgren et al. 2018), meaning higher coverage of semi-natural areas and smaller fields.

Pest populations tend to benefit from agricultural intensification, having high quantity of host plants (Thies et al. 2011). Aphids' life cycles are for example closely related to their hosts, they hence benefit from landscape intensification where crops dominate. On the contrary, the higher level of pest control in more complex landscapes is due to a more continuous and higher availability of food resources, such as alternative preys, pollen and nectar, as well as refuge and overwintering habitats (Landis et al. 2000; Östman et al. 2001a; Woodcock et al. 2016). Indeed, natural enemies need more than their prey or host to survive, since cropped habitats only provide high amounts of prey resource at certain times of the year (Coll and Guershon 2002; Wäckers et al. 2005).

To be maintained, biological control hence needs alternative preys and shelter habitats to conserve natural enemies: this is conservation biological control (Tscharntke et al. 2007; Jonsson et al. 2008). Alternative preys can be found in adjacent patches, be they natural, semi-natural or sown (for instance grassy or flower strips). Many predatory natural enemies find overwintering habitats in hedgerows, for example. Hence, their abundance and diversity benefit from reduced management of hedgerows (Altieri et al. 2018). Moreover, the spraying of herbicides in adjacent fields negatively affects the hedgerow bottom flora, hence the insects which harbor there, also contributes to reduce the diversity of natural enemies. Conservation biological control thus aims at promoting practices which favor natural enemies by conserving and enhancing their already present populations in farmlands (Tscharntke et al. 2007).

1.2.2.1. Carabids: pest and weed regulators

Carabids are important biological control providers (Kromp 1989; Kromp 1999; Moonen and Bàrberi 2008). They are ground dwellers and colonize field crops such as cereal and maize, mainly preying on aphids. Larger species, such as *Abax parallelepipedus* are also known to forage on slugs and snails. Most predatory carabids are generalist, meaning they do not forage on specific preys, whereas the few specialists feed on collembolans. Other phytophagous species, in the genera *Amara* or *Harpalus* for instance, feed on weed seeds. Hence, by their diversity, carabids can provide a wide range of biological control to farming activities through pest and weed seed predation. Carabids' efficiency in pest predation is due to their voracious behavior: they consume almost the equivalent of their own body mass every day.

Polyphagous species, feeding on both weed seed and aphids, are known to be efficient natural enemies in fields crops (Ekbohm et al. 1992; Moonen and Bàrberi 2008). These species are favored by higher configurational heterogeneity, meaning higher vicinity to a diversity of habitats (Östman et al., 2001).

Carabid species indeed also benefit from higher compositional diversity in agricultural landscapes. However, polyphagous species can have various needs in terms of habitats around the cropped fields. *Pterostichus melanarius* for instance needs the proximity of cropland and woodland as the adults reproduce in the first and dwell in the second.

Furthermore, farmland carabid species richness and density decrease with larger fields and with fewer semi-natural habitats in their vicinity (Baranová et al. 2013). The proximity of grasslands and hedgerows is indeed an important factor to enhance carabid diversity (Purtauf et al. 2005; Duflot et al. 2017; Holland et al. 2017). In simpler cropped landscapes, the assemblages tend to be dominated by a reduced number of species (Baranová et al. 2013; Bertrand et al. 2016), being selected by their tolerance to anthropogenic disturbance due to farming activities (Thiele 1977; Luff 1996; Kromp 1999).

Some farming practices have negative effects on carabid populations, mainly intensive ones. In general, ground-dwelling invertebrates, among them carabids, are affected by tillage, since it alters the amount of surface residues and the weed diversity (Kromp 1999; Menalled et al. 2007). Thus, no- or conservation tillage conditions have proved to benefit carabid diversity. The use of herbicides and insecticides have respectively indirect and direct effects on carabid diversity, either by killing the individuals, or by reducing their food resource, be they prey insects or weed (Chiverton and Sotherton 1991; Menalled et al. 2007)

Concerning the fertilization, organic fertilization enhances carabid species richness and density by favoring micro-arthropods activity on the ground surface (Pfiffner and Luka 2003). On the contrary, comparative studies showed lower carabid diversity in fields with mineral fertilizer (Kromp 1999). Crop rotations, though determined by agricultural practices, are also markers of spatiotemporal heterogeneity of landscapes. Carabid communities are indeed more diverse in agricultural mosaics with more heterogeneous rotations (Bertrand et al. 2016). Carabids are then able to find a continuity of suitable habitats across time. More diversified crop rotations also tend to favor more generalist species, such as *P. melanarius* or *Poecilus cupreus*.

However, the gap in carabid diversity between intensive and more diversified cropping systems is not observable anymore in heterogeneous landscapes, with smaller fields to facilitate the movement of carabids, and semi-natural elements to shelter them in case of disturbance (Kromp 1999). Within-field mixed crops favor higher carabid diversity, for the same reason as denser and more diverse vegetative weeds within-field cover (Kromp 1989; Pfiffner and Luka 2003).

1.2.2.2. Other ground-dwelling beneficial insects and weed regulators

Carabids are not the only ground-dwelling family that support biological control: spiders and rove beetles can also prey on pests, notably aphids (Sunderland et al. 1986; Ekschmitt et al. 1997; Schmidt et al. 2003; Moonen and Bàrberi 2008). Numerous spider families can contribute to biological control: wolf spiders (Lycosidae), money spiders (Linyphiidae) are the most encountered in fields, often making up to the whole spider fauna in cropped fields. Wolf spiders are a cursorial hunting family, meaning they wait for ambushing their preys. On the contrary, money spiders are sheet-web weavers: their foraging strategy consists in waiting hung underneath their sheet-web, which they pull to trap a prey (Ekschmitt et al. 1997). Spiders are generalist insect predators, feeding mostly on collembolas, aphids, thrips and small flies, which makes turns them into polyvalent pest regulators, even though most of their preys are aphids in Europe (Nyffeler and Sunderland 2003).

Rove beetles are one the largest family among the Coleoptera. They are generalist, fast and agile predators, particularly for Staphylininae, Paederinae and Steninae, which prey on a variety of pest invertebrates such as nematodes, mites or even other Coleoptera, either adults or larvae (Ekschmitt et al. 1997; Bohac 1999; Moonen and Bàrberi 2008; Frank and Thomas 2016). However, small-bodied families, *i.e.* Tachyporinae, are polyphagous, feeding on both small invertebrates and fungi, though they also contribute to the recycling of the soil organic matter.

Like carabids, wolf spiders and rove beetles are negatively affected by tillage (Ekschmitt et al. 1997; Sunderland and Samu 2000), though money spiders appear to be more resilient. To a certain point, mineral fertilization can benefit ground-dwelling natural enemies, providing more numerous populations of preys. Although high doses of mineral fertilizers appeared to be harmful, mainly by decreasing the soil humidity (Ekschmitt et al. 1997). Organic fertilization is beneficial for rove beetles, like it is for carabids, reflecting an increase in the prey resource (Bohac 1999). Spiders and rove beetles are affected by pesticide applications the same way than carabids: directly by killing of individuals as well as indirectly by reducing their food resource. The harvest season is a critical period for spiders, whose eggs are destroyed while laid in the ground or in cereal stems. However, spiders can recolonize cropped fields from adjacent fields, hence they need the vicinity of more stable, uncropped, semi-natural habitats (Ekschmitt et al. 1997). Indeed, higher spider diversity is found in landscapes with higher density of hedgerows and field margins (Sunderland and Samu 2000). More interestingly, wolf spiders tend to be more abundant at the field edges, from which they can emigrate easily into the neighboring habitats in case of anthropogenic disturbance. Contrarily, money spiders are more abundant in the field center, since they are aeronaut, thus less impacted by farming activities. Higher compositional heterogeneity favors the dispersal of aeronaut spider species, offering the continuous vegetative cover they need to move (Sunderland and Samu 2000).

Rove beetles are highly affected by the presence of dark and shaded habitats and micro-habitats, hence insolation is one major determinant of their diversity (Dauber et al. 2005). Moreover, rove beetle diversity is enhanced by more complex landscapes, mainly in presence of hedgerows, smaller fields and wood covers (Bohac 1999). Thus, they benefit from the presence of trees in hedgerows where they can find refuge from daylight as well as overwinter (Garratt et al. 2017). Simpler landscapes tend to show rove beetle assemblages dominated by a few ubiquitous species.

1.2.3. Landscape, insects and pollination

Agricultural landscapes pollinators regroup a wide range of taxa, including bees (Apidae), butterflies (Lepidoptera), hoverflies (Syrphidae) being among the most important (Moonen and Bàrberi 2008; Ollerton 2017). Even though butterflies are the most diverse taxon, bees and hoverflies have the higher pollination rates, having more plant species directly depending on them to ensure their reproduction. They are essential to a wide range of cross-pollinated entomophilous crops such as oil and protein crops, as well as fruits and vegetables (Winfree et al. 2011). All of these pollinators taxa have been declining since the beginning of agricultural intensification in Europe (Ollerton 2017).

They are highly related to floral diversity since they need to find a continuous food resource across time (Le Féon et al. 2010; Cole et al. 2017). Summer appears to be a crucial period for their survival since it is impoverished in floral diversity: semi-natural habitats, including road sides and riparian buffer strips, are good providers of continuous floral richness across time (Cole et al. 2017). Bee species richness and abundance is indeed lower in simpler landscapes, with fewer semi-natural habitats and habitat diversity (Steffan-Dewenter et al. 2002). Furthermore, bees are more diverse in mixed farms landscapes, associated with extensive livestock management and diversified cropping systems (Le Féon et al. 2010).

In homogenized landscapes, pollination mainly relies on species with wide foraging range, such as bumblebees and honeybees. Larger pollinators, with better flight abilities, thereby show less sensitivity than smaller ones to crop homogenization and intensive practices. Their higher mobility allow them to move from one crop to another and find more easily the food resource they are searching for (Le Féon et al. 2010). Nonetheless, Happe et al. (2018) found that bumblebees richness is positively affected by higher configurational heterogeneity. Indeed, bumblebees highly forage in field boundaries, and small-scale agriculture enhances the floral diversity and the density of field boundaries.

Solitary wild bees are more dependent on the vicinity semi-natural habitats and are less mobile, they are thereby more impacted by the intensification of agricultural landscapes. Therefore, solitary wild bees are more responsive to small-scale landscapes than bumblebees or honeybees. Moreover, the

decline of the diversity and specialization of pollinators in simple landscapes can also cause the long term loss of floral diversity, since many plants rely on specialized solitary bees (Kearns et al. 1998). Higher landscape heterogeneity favors bumblebee and butterfly diversity, in organic as well as in conventional farming contexts (Rundlöf and Smith 2006; Rundlöf et al. 2008). Compositional heterogeneity especially enhances butterfly diversity (Perović et al. 2015)

Furthermore, the presence of organically managed fields in the landscape favors higher solitary and bumblebee species (Holzschuh et al. 2008; Kennedy et al. 2013). Indeed, organic farming favor higher floral diversity, and hence can attract more diverse bee species. Wild bees are also favored by the vicinity of semi-natural areas in the landscape (Kennedy et al. 2013).

Hoverflies are of double interest for agriculture, since their larvae can be aphid predators or decomposers, according to the species (Moonen and Bàrberi 2008; Moquet et al. 2018). Hence, the availability of foraging resources for both adults and larvae are necessary to hoverflies. Larvae indeed need a diversity of microhabitats, even fragmentary woody areas, at the landscape scale, whereas adults need floral diversity at the plot scale (Moquet et al. 2018). Moreover, hoverflies tend to feed on understory plants of hedgerows, while more complex hedgerows are foraged by higher bumblebee richness (Garratt et al. 2017).

We observed that agriculture affects beneficial entomofauna in many ways, both through practices and landscape context, sometimes through the interaction of the twice. The ecological theory anyhow supports these impacts of agriculture on biodiversity and can help explaining them.

1.3. Landscape functional heterogeneity

1.3.1. Limits of the fragmentation model

Since the 1970's, the fragmentation model has offered a useful conceptual framework for conservation biologists and landscape ecologists. It relies on three main assumptions (Haila 2002): (i) the island analogy, (ii) the acute contrast between suited habitats and the surrounding matrix, and (iii) the uniformity of natural conditions. The fragmentation model therefore focused on the biodiversity decline due to the destruction and fragmentation of natural habitats, or biodiversity reserves, in a matrix of hostile anthropogenic environment. Furthermore, natural habitats can be linked together by corridors that allow the move and dispersion of wildlife through the hostile anthropogenic matrix (Figure 6). The fragmentation model took form in the ecological connectivity (Baudry and Merriam 1988) and the patch-matrix-corridor representations (Forman 1995).

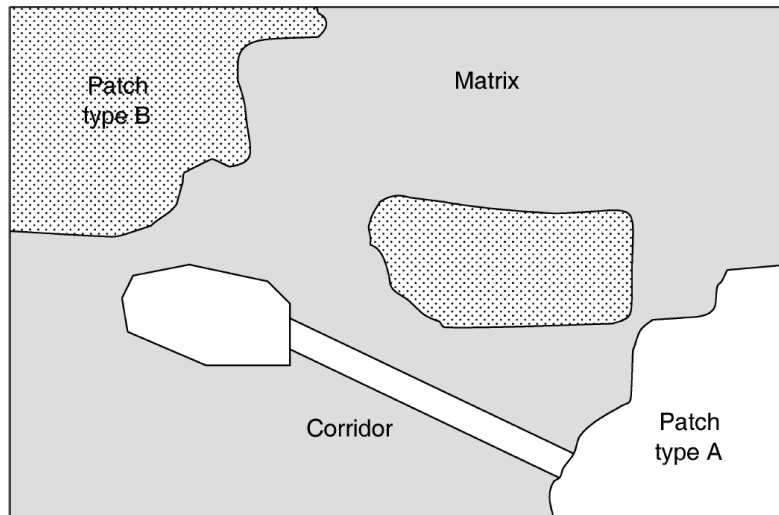

Figure 6. Patch-corridor-matrix representation inherited from the fragmentation model
(Source: Fischer and Lindenmayer, 2007)

However, the notion of hostile anthropogenic matrix meets empirical limitations. Many species have wide range of habitat suitability, and thus are not impacted the same way and at the same levels by habitat fragmentation (Haila 2002). Moreover, it has been pointed out that it is not necessarily the mere occurrence of one habitat that is needed by some species, but also its size. More importantly, the uniformity assumption failed to take into consideration the role of environmental heterogeneity, spatial as well as temporal, into the determination of ecological communities composition and richness (Haila 2002). In response to this criticism, Fahrig (2003) helped refining the fragmentation framework. A clear distinction was then made between habitat fragmentation and habitat loss, and the size of the patches matters. Nonetheless, one major issue remained: the binary perception of the landscape mosaic between suitable habitats in a hostile matrix.

Consequently, the continuum model emerged as a complementation (Fischer and Lindenmayer 2006) and predicts that species have peculiar requirements of environmental gradients: food, shelter, space and climatic conditions (Figure 7). The continuum model allows to consider the landscape in gradients, but its limitation is in the species-specific point of view that it addresses, which can be an obstacle to the study of communities. Moreover, even though the continuum model is more complex than the fragmentation model, it fails to include the interspecific relationships, as well as cross-scale effects (Fischer and Lindenmayer 2006).

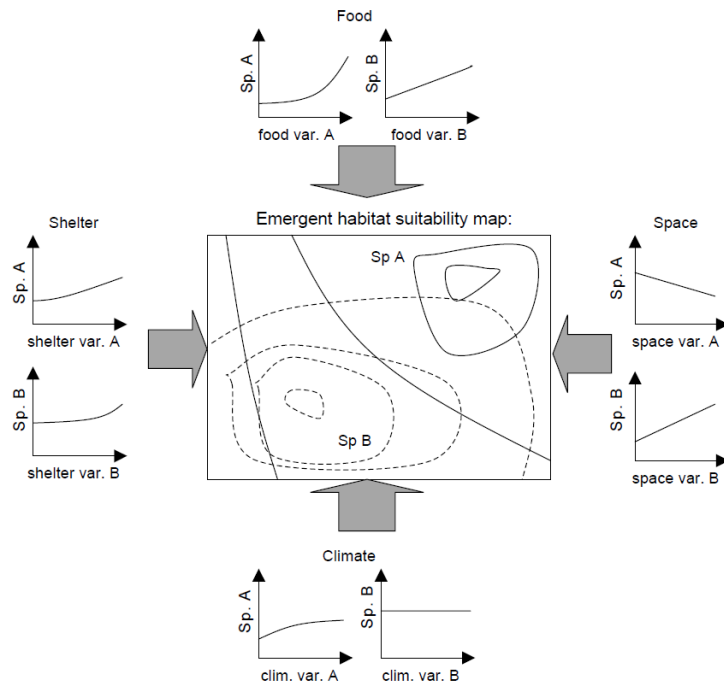

Figure 7. Continuum model illustration (Source: Fischer and Lindenmayer, 2006)

Nevertheless, the continuum and fragmentation models both show strong limitations for applied research (Fischer and Lindenmayer 2007). On one hand, the fragmentation model, being highly pattern-oriented, is highly attached to the human perception of landscape and land covers to infer ecological causalities. This can lead to amalgamate ecological and species processes (Fischer and Lindenmayer 2007). On the other hand, the continuum model is highly species-oriented and the quantification of every gradient can be tedious and complex (Fischer and Lindenmayer 2006; Fischer and Lindenmayer 2007). Moreover, it fails to find patterns between landscape and species distribution. Therefore, Fischer and Lindenmayer (2007) emphasized the need to have complementary approaches between species-oriented and pattern-oriented, taking also in consideration the ecological processes.

1.3.2. Landscape functional heterogeneity, an intermediate framework

1.3.2.1. Functional heterogeneity

The landscape functional heterogeneity is an ecological framework which makes compromises between the fragmentation and continuum models and has been originally formulated by Fahrig et al. (2011). Indeed, it keeps a simple landscape categorization of land cover types like in the fragmentation model. Although, it is not so binary: the land cover categories correspond to the level of ecological functions that the type can provide to a certain species group. Species are thereby grouped by the land cover type they need to meet their needs for resource. The resource term is to be taken at a wide sense, it includes food, shelter, nesting or reproduction habitats etc. Hence, some species can need

the same habitat, though they use different resource it provides (Fahrig et al. 2011). Since the functional heterogeneity considers the resource needs of species, it also draws inspiration from the continuum model. The fact that the species groups are formed from the land cover types or habitats they use to meet their resource needs is the reason why the landscape heterogeneity is perceived as functional in this model.

When applied to agricultural landscapes, the functional heterogeneity framework gives interesting advantages. In the first land cover dichotomy, Fahrig et al. (2011) differentiate natural land covers and production covers. However, these two kinds of land covers are not clear-cut, since there are many gradients to go from full-natural to full-production covers, mostly differentiated by the level of primary production which is consumed by humans. Natural areas, such as woodland, are then considered as an extreme end of this dichotomy, though hedgerows or herbaceous field edges are as well. At the opposite end, we would find intensively cropped fields, even if there is always a part of their primary production which feeds wild species such as pests or weed. Then, semi-natural grasslands are considered halfway between natural and production covers.

As shown in 1.1.4, non-cropped habitats are highly important to enhance biodiversity in agricultural landscapes. However, they are of no or little economic interest for farmers (at least not directly visible), since they cannot directly benefit from them. Natural and semi-natural areas nevertheless can provide ecosystem services which in the end benefit to agriculture. One main point is thereby to balance agricultural landscapes between natural and production covers (Fahrig et al. 2011), in order to provide both food for human consumption and ensure the sustainability of ecosystem services that farming activities can benefit from.

1.3.2.2. Landscape complementation

Landscape complementation is an implication of the functional heterogeneity model. As said before, a resource can take multiple forms: food, shelter or even breeding site. Landscape complementation is considered when the two habitats are neighboring, allowing the species to efficiently benefit from the resources of each of them (Dunning et al. 1992): the presence of the resource in one habitat patch is complemented for the given species by the presence of the other habitat patch. Landscape complementation is analogous to Tilman's (1982) resource complementation, though its scale is wider. Then, landscape complementation suggests that higher landscape heterogeneity enhances the richness of species needing multiple habitats to meet their needs (Figure 8).

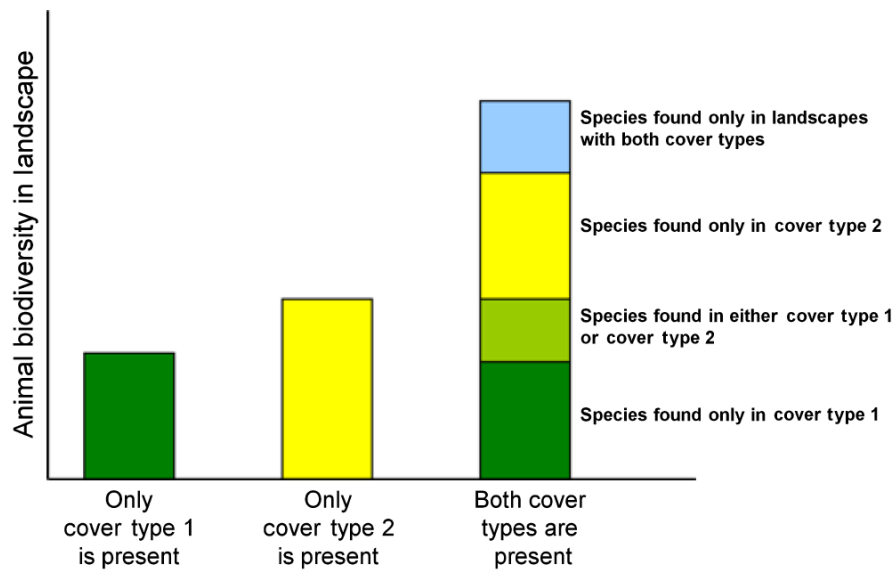

Figure 8. Illustrated effect of landscape complementation on biodiversity (Source: Fahrig et al., 2011)

Common illustration of landscape complementation is in Choquenot and Ruscoe's (2003) study on wild boars (*Sus scrofa*). Two different habitats were identified to be important for wild boars' biological cycle: riverine woodlands as refuge and pastures as foraging resource. Choquenot and Ruscoe then demonstrated that the further distant the two habitats were, the lower the foraging efficiency was in the pasture. Their conclusion is finally that wild boar populations need landscapes where the two habitats are distant by less than 10 km. Landscape complementation has also been observed for habitat generalist such as ravens (*Corvus corax*) (Mueller et al. 2009). Raven populations decline was noticed over 16 years where woody habitats were modified by the reduction of ungulate densities. Indeed, though the nesting sites of ravens were mostly in coniferous forests, their reproductive success was higher in small pine forests which were complemented by deciduous forests as well as open areas. It has then been shown that deciduous and open habitats provided higher food supplies to ravens.

Landscape supplementation is an inference of landscape complementation, and applies when the original habitat of a species is destroyed or substantially disturbed, or in the case that their habitat patches are too far away to allow any dispersal (Dunning et al. 1992). A good illustration of landscape supplementation can be found in Miyashita et al. (2012). They studied the spider communities of grasslands and found that spider species richness and abundance were higher when there was both forest and paddy fields in the surrounding landscape. They concluded that grassland spiders use forest margins as refuge habitats during grassland mowing and, moreover, that paddy fields and forests provide foraging resource to stabilize the spider community. Interestingly, they also deduced that prey species may also benefit from landscape complementation between grasslands and forests for alternative food.

Though landscape complementation was prior to the questioning of the fragmentation concept, it has the qualities of an intermediate way between species-oriented and pattern-oriented approaches (Fahrig et al. 2011). It allows pattern-oriented approaches, giving depth to the impact of landscape heterogeneity on species distribution by considering the interactions between various habitat patches. Thereby, Fahrig et al. (2011) extends the notion of suitable habitat, inherited from the fragmentation model, to the one functional cover type. The functionality of a cover type is related to the provision of resource to a set of different species. Beneficial cover types provide one or more resource, while neutral cover types do not, even though they can be moved through without risk. Finally, dangerous cover types are avoided by the concerned set of species, since they do not furnish any resource and are dangerous to move through.

1.3.3. Implications for biodiversity at local scale

Landscape complementation therefore explains that the diversity of two different habitats in vicinity is higher than the sum of their proper diversities (Figure 8). Indeed, some species need a variety of habitats to fulfill their biological cycle, for example to find both foraging and shelter resources. Landscape complementation thereby postulates that the correlation between biodiversity and landscape heterogeneity is not linear.

Magura et al. (2017) studied the case of natural forest edges within agricultural landscapes. They observed that forest edges could enhance local carabid and spider diversity by the provision of multiple resources such as food, shelter, nesting or overwintering habitats. This was particularly true in the case of semi-natural field edges. They therefore host species from the communities of adjacent habitats, as well as proper species needing this ecotone.

In their work about skylarks (*Alauda arvensis*) in agricultural landscapes, Miguet et al. (2013) demonstrated that these birds would rather nest in temporary grasslands, mainly sown alfalfa, in landscapes with a diversity of neighboring crops. Moreover, the presence of both winter and spring crops benefits to skylark density, which points out a complementation effect. Indeed, while grasslands offer a quite stable nesting site, cereal and spring crops can provide a continuous foraging resource, invertebrates in the case of skylarks, all throughout the breeding season. Furthermore, when nesting in crops, skylarks appeared to switch their nesting site to spring crops when the cereal crop canopy becomes too high, around May.

Landscape complementation processes can also be favored by higher configurational heterogeneity (Brotans et al. 2004; Fahrig et al. 2011). Highest edge density between complementary habitats can enhance the multi-habitat diversity needing both habitats. Ecotones are thereby obvious examples of

complementation between two habitat patches, which explains why landscape configurational heterogeneity also plays a role in functional heterogeneity.

1.3.4. Implications for biodiversity at the landscape scale

Firstly, landscape complementation indicates that increasing semi-natural coverage and diversity enhances biodiversity in agricultural landscapes (Fahrig et al. 2011). Semi-natural areas are more stable habitats, hence fauna can spillover in case of disturbance of their original farmed habitat, like during the harvest or mowing period. They indeed can provide complementary resources from cropland, such as refuge or alternative food (Lee et al. 2001a; Devictor and Jiguet 2007; Schirmel et al. 2016). Empirical evidence shows that higher semi-natural coverage benefits to faunal diversity as it is the case for carabids (Aviron et al. 2005; Fusser et al. 2017), or ground-dwelling and flying arthropods, birds and plants (Billeter et al. 2008).

Secondly, increasing crop diversity enhances biodiversity (Fahrig et al. 2011). This differs from the classical landscape fragmentation model where the arable land covers are only perceived as a hostile matrix for faunal species (Haila 2002). Large bodies of evidence have been brought to support this implication of landscape complementation (Benton et al. 2003). For example, Jonsen and Fahrig (1997) found that herbivorous arthropods were more diverse and abundant in landscapes with higher crop diversity, thus they move from crop type to another whenever they need to find new resources. Carabids (Östman et al. 2001b) and spiders (Sunderland and Samu 2000) are also sensible to crop diversity, since they can move from one crop to another to find forage resources or shelter to overcome the disturbances which are typical to farmed areas.

Thirdly, small-scale farming benefits biodiversity through landscape complementation (Fahrig et al. 2011; Fahrig et al. 2015). Smaller field sizes allow more interdispersion and juxtaposition between various farmed land cover types. Small-scale landscapes therefore augment possibilities of fauna to find various resources from different cover types by increasing the boundaries density between different habitats. Agricultural biodiversity, including multitrophic levels such as plants, birds, butterflies, hoverflies, bees, carabids and spiders, appears to respond positively to smaller fields (Fahrig et al. 2015).

In accordance with all these implications, Sirami et al. (2019) found that the combination of these three factors consistently enhances the diversity of seven multitrophic taxa, including plants, bees, butterflies, hover flies, carabids, spiders and birds, across eight European and North American regions. They indeed observed that the multitrophic diversity was higher with higher semi-natural coverage, more diverse crops and smaller fields. Accordingly, to landscape complementation, they concluded

that species would find temporal continuity in a more diverse crop matrix, as well as stable resources in semi-natural habitats, while smaller fields ease the mobility from one land cover type to another.

1.4. Scope of the thesis

1.4.1. Knowledge gaps

Landscape context is an important driver of arthropod biodiversity in agricultural landscapes (Stoate et al. 2009; Dainese et al. 2019). Even though species can have various individual responses, higher compositional and configurational heterogeneity enhance overall farmland diversity (Fahrig et al. 2011; Sirami et al. 2019). Besides crop diversity, semi-natural areas, such as permanent grasslands play a major role in the enhancement of farmland biodiversity (Dauber et al. 2005; Purtauf et al. 2005; Bianchi et al. 2006; Sirami et al. 2019). Functional heterogeneity, through landscape complementation between croplands and grasslands, legitimately explains such biodiversity enhancement, through the provision of continuous resource in close cropped and non-cropped habitat patches (Thorbeck and Bilde 2004; Schirmel et al. 2016). Furthermore, carabids are an interesting family to study: they are well known in the northern hemisphere, notably in agricultural landscapes, and they provide important ecosystem services through the predation of pests (Kromp 1999; Sunderland and Samu 2000; Nyffeler and Sunderland 2003; Bianchi et al. 2006). As they are ground-dwelling, carabids dispersal ability is more likely to be affected by the adjacency between grasslands and croplands (Purtauf et al. 2005; Dufлот et al. 2017; Holland et al. 2017). They appear to be good witnesses of the effect of the vicinity between these two land cover types in farmlands. However, other beneficial species can be of interest as well, such as spiders, some of which are also ground dwellers and positively affected by the vicinity of grasslands (Ekschmitt et al. 1997). Pollinators such as hoverflies and lacewings are also positively influenced by the vicinity of grasslands and crops, as some species' larvae feed on crop aphids, while the adults need a floral diversity, hence semi-natural habitats, to find forage resource (Moquet et al. 2018).

Therefore, better knowledge about the similarities between the carabid communities from adjacent cropland and grassland would be of great interest. This would provide better understanding of the carabid abundance and richness which can be concerned by the landscape complementation provided by grasslands to cereal crops communities, or vice versa. These two land cover types each represent a different level of anthropogenic disturbance due to farming activities, and can show contrasting effects on arthropod communities, even when closely located. Moreover, since the landscape context impacts on farmland carabid communities, we lack information about how it impacts on the beneficial

arthropod diversity of these grasslands and croplands, and on the carabids species they share. Higher knowledge about the occurrence of carabid life traits providing ecosystem services for agriculture is needed. Finally, further understanding of the impacts of field and landscape parameters would be needed on the abundance or richness of other beneficial arthropods, both ground-dwelling, like spiders, and flying, like hoverflies and lacewings, since these groups can also benefit from the vicinity of crops and grasslands.

1.4.2. Frame of study

This PhD thesis was funded by the European Union and the Region of Auvergne Rhône-Alpes through the European Regional Development Fund (reference RA RA0015616). The research program “Ecological permeability of agricultural areas” took place in the frame of the SRCE Rhône Alpes, the regional ecological consistency scheme, which aims at the identification, cartography, preservation and restoration of ecological connectivity.

Being funded by public funds this thesis aims at contributing to the enhancement of applied agroecological knowledge, relevant for stakeholders such as farmers, land planners or policy makers, for conservation and best management of biodiversity in agricultural landscapes by increasing or assuring connectivity between habitats and for functional biodiversity. In the case of this thesis, it looks more specifically on the question of revalorization of grasslands or semi-natural landscape elements for functional biodiversity, but also the potential contribution from cropped fields and the role diversified farming systems can play.

1.4.3. Research question and hypotheses

The core objective of this PhD is to deepen the knowledge about the carabid communities and other selected natural enemies and pollinator groups of two important farmland cover types: permanent grasslands and winter cereal fields in taking into account the landscape context. We aim at answering to the following research questions.

Research question 1: How similar are carabid assemblages from neighboring permanent grasslands and cereal fields?

Habitat is one major determinant of carabid assemblages (Thiele 1977; Kromp 1999; Dauber et al. 2005). However, carabids can move between adjacent cropped fields and grasslands, and some species can hereby occupy both land covers and highlight the landscape complementation process (Dunning et al. 1992; Fahrig et al. 2011). We here hypothesize that the carabid assemblages from the two land cover types have carabid species in common and neighboring fields share more common species than

more distant ones (*hypothesis 1*), which would give evidence to the potential resource complementation between these two land cover types.

Moreover, a functional analysis of carabid assemblages would help to find out whether the species found in both adjacent grasslands and cereal crops contain traits beneficial for agriculture (Kromp 1989; Kromp 1999; Holland 2002). We hypothesize that the common species to both land covers are rather generalist, being more mobile and polyphagous (*hypothesis 2*). Indeed, polyphagous species can provide pest control as well as benefit from a refuge habitat, such as grassland (Symondson et al. 2002).

Research question 2: How does the landscape context influence the carabid diversity of paired adjacent permanent grasslands and cereal crops?

Many studies have documented the importance of the landscape context to enhance farmland carabid richness. However, most of them have focused on only one habitat, being cropland (Purtauf et al. 2005; Holland et al. 2017), grassland (Grandchamp et al. 2005; Batáry et al. 2007) or field margins (Thomas and Marshall 1999; Alignier and Aviron 2017). When carabids were sampled in multiple habitats, their diversity was considered altogether in order to study the multi-habitat gamma species richness (Dufлот et al. 2017). Overall, past studies show that landscape heterogeneity enhances carabid diversity in farmland (Sirami et al. 2019). Here we hypothesize that higher compositional and configurational landscape heterogeneity foster carabid diversity in both cereal crops and permanent grasslands (*hypothesis 3*). Moreover, we expect that higher semi-natural landscape elements coverage in the surrounding landscape enhances carabid diversity in both cereal crops and permanent grasslands (*hypothesis 4*)

Since we hypothesized that the common species in both adjacent cereal crop and grassland will be explained by the landscape complementation process, we hereby hypothesize that closer adjacency and higher rate adjacency between cereal crops and grasslands in the surrounding landscape enhances the ratio of common species in adjacent fields (*hypothesis 5*).

Finally, as both landscape and habitat drive carabid functional traits occurrence (Dufлот et al. 2014; Magura et al. 2015; Gámez-Virués et al. 2015), we assume that grassland carabids are more phytophagous and less mobile, while cropland are more predatory and more mobile (*hypothesis 6*). Moreover, we expect to find more mobile species in carabid communities of low-heterogeneity landscapes (*hypothesis 7*). Indeed, simpler landscapes tend to favor carabids with higher dispersal ability, since they need to adapt rapidly to the change of distribution of resource (Dufлот et al. 2014)

Research question 3: What are the influences of field and landscape parameters on the grassland and cereal field communities of other beneficial arthropods such as spiders and pollinators?

Spiders benefit from diverse landscapes, with a variety of crops and non-cropped habitats. They can indeed find shelter from the anthropogenic disturbance of farming activities in this heterogeneity of land cover types (Ekschmitt et al. 1997; Sunderland and Samu 2000). Thereby, we expect to find higher spider richness and abundance in landscapes with higher grassland coverage and higher landscape compositional heterogeneity (*hypothesis 8*).

Pollinator diversity, like hoverflies and lacewings, is enhanced by higher floral diversity, since they are highly dependent on a continuous forage resource (Le Féon et al. 2010; Cole et al. 2017). Therefore, semi-natural covers, such as grasslands can provide them complementary floral resource from croplands and enhance their diversity (Cole et al. 2017). In this regard we hypothesize that more lacewings and hoverflies are found with higher grassland coverage in the surroundings of cereal fields (*hypothesis 9*).

1.4.4. Thesis plan

In order to answer to these research questions and verify our hypotheses, this thesis is organized through one chapter presenting the material and methods, and four chapters presenting results, among which three are original articles (either in press, under review or still in preparation). Then, we finish with discussing our findings and observations. The following four results chapters consist of:

3. Complementarity of grasslands and cereal fields ensures carabid diversity in French agricultural landscapes (Article 1)

This chapter aims at assessing the carabid diversity using both different indicators and developing assemblage similarity analyses in neighboring pairs of grasslands and cereal fields. Carabids were sampled in 104 pairs of cereal fields and grasslands in three agricultural landscapes of southeastern France. Carabid diversity was measured through species richness (α , β and γ), evenness and activity-density. We further tested with multivariate analysis different local and regional parameters and the correlations between assemblage similarities and geographical distance of sampled cereal fields and grasslands.

4. Landscape diversity and field border density enhance carabid diversity in adjacent grasslands and cereal fields (Article 2)

In this chapter, we disentangle the effects of different landscape indicators in radii from 200 to 500 m around sampled sites in three agricultural landscapes in France on carabid diversity from bordering

cereal crops and permanent grasslands. We study the carabid richness from each of these two land cover types as well as the global gamma diversity from both in relation to landscape composition and configuration.

5. Functional traits of carabid assemblages in adjacent grasslands and cereal fields (Article 3)

In this chapter, we aim at differentiating life traits of carabids which are found exclusively in paired grasslands or cereal crops, or common to both land cover types. We also disentangle the influence of the landscape context on the selection of carabid life traits in cereal crops and permanent grasslands.

6. Influence of the landscape context on pollinators and spiders

This chapter focuses on providing a wider view of the effects that we observed on carabids in the previous chapters. We hereby study the diversity of other ground-dwelling natural enemies in looking at spiders and two pollinator groups, in pairs of neighboring cereal fields and grasslands. Both the landscape context and habitat parameters are analyzed.

2. Material and methods

In this chapter, we will present a broad overview of the study regions, our sampling methods and protocol and statistical analyses. Adequate and deeper details will be given about every of these points in the concerned results chapter.

2.1. Study regions

Our study took place in three agricultural plains of the Auvergne Rhône-Alpes region in southeastern France (Figure 9 and Figure 10a, Figure 10b and Figure 10c) which consist of cropland, grassland, and woodland, but also some urban land and road infrastructure. The Bièvre and Rovaltain study regions are characterized by the dominance of crops such as maize, wheat, and oilseed rape. In Forez, livestock systems with use of permanent grasslands are more present than cropped areas. Our three study regions are representative of a gradient of grassland coverage: they represent 3 % of the whole area in Rovaltain, 16 % in Bièvre and 27 % in Forez (Table 1). Average field size was 2.0 ha in Bièvre study region, 2.1 ha in Rovaltain and 2.9 ha in Forez. Rovaltain and Forez have about the same woody area relative share, whereas in Bièvre it is slightly higher, mostly due to the north and south foothills which border the agricultural plain.

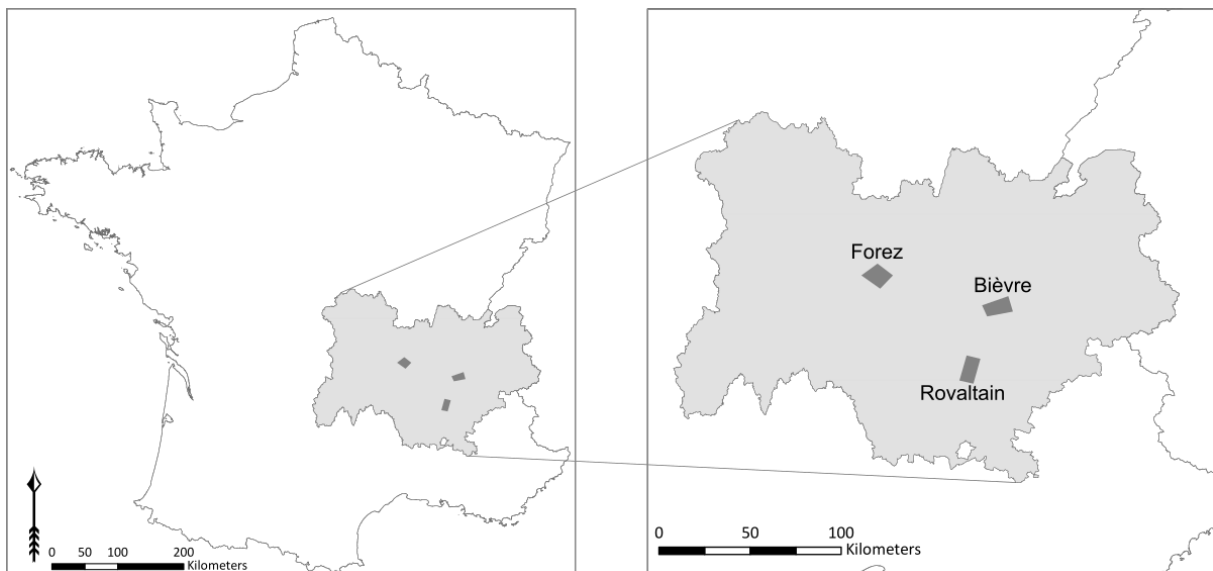

Figure 9. Study regions locations in France and Auvergne Rhône-Alpes region

Table 1. Land cover characteristics of the three study regions in southeastern France.

Study region	Whole study region		Farmland		Winter cereals		Spring crops		Other farmland ^a		Permanent grasslands		Woodland ^b	
	ha	%	ha	%	ha	%	ha	%	ha	%	ha	%	ha	%
Rovaltain	23,030	100	15,550	68	6,070	26	5,010	22	3,873	17	597	3	2,672	12
Bièvre	23,949	100	15,363	64	4,389	18	4,034	17	3,153	13	3,787	16	3,779	16
Forez	25,002	100	15,555	62	2,428	8	2,634	11	3,745	15	6,749	27	2,729	11

^a By importance of area: temporary grasslands, rapeseed, orchards and vineyards

Annual precipitations are around 650 mm in Forez with two peaks in early and late summer. In Bièvre, yearly rainfall is around 960 mm, with peaks in early summer and autumn, and in Rovaltain around 880 mm with peaks during late spring and autumn. Soils in Forez are mostly sandy-loamy, with some clayey areas and alluvial soils on the banks of the Loire river. The Rovaltain study region is bordered by one major French river, the Rhône, and one of its affluent, the Isère; the plain results from the melting of glaciers, forming up today alluvial silty soils. The Bièvre plain is our only study region which is not bordered by a major river and results from the withdrawal of a glacier, hence its moraine soils are mostly alluvial and gravel nature, with a dominance of silty soils on the western third of the study region. Forez and Bièvre have temperate semi-continental climate, whereas Rovaltain is influenced by both semi-continental and Mediterranean climate.

Like in other parts of France, crops are tilled (mostly between 20 and 25 cm deep) (Labreuche et al. 2011), chemically fertilized, as well as preventively protected through the application of pesticides, fungicides and herbicides (Butault et al. 2011). Winter cereals are typically sown in fall and harvested in June and July while spring crops are sown in April and May and harvested during late September and October. One precautionary application of herbicides is commonly applied to cereals, before or after winter. One preventive spraying of fungicides is applied during spring to avoid common fungal diseases with the increase of temperature and moisture. The use of pesticides can be more intense and is variable according to annual and local climate conditions. Permanent grasslands are mainly mown two to three times, and sometimes grazed.

The three study regions were also chosen because of the commitment to the SRCE project by the local actors, including farmers, public institutes, such as territorial authorities or chambers of agriculture, or even naturalist NGOs.

(a)



(b)



(c)



(d)



(e)

Figure 10. Photographs of the three study regions (a) Bièvre, (b) Forez and (c) Rovaltain, (d) pitfall trap and (e) flight trap in a winter cereal field.

2.2. Sampling methods and protocol

For the sampling of carabids and other insects, we selected two contrasted agricultural land cover types in the different agricultural landscapes studied corresponding to different intensities of management and inputs: winter cereals and permanent grasslands. We thereby selected pairs of sampling sites where cereal and grasslands fields were adjacent or in close vicinity, thus also having almost identical landscape context. We tried though to use as few as possible grazed grasslands since cattle could damage the traps we set. We chose winter cereals since they were the most common crops overall in the three study regions. They respectively occupy 26 %, 18 % and 8 % of the whole study region in Rovaltain, Bièvre and Forez (Table 1). Sampled cereal fields were primarily cropped with wheat and barley and in fewer cases with triticale and rye. They were for the most fields tilled and synthetic inputs were used for fertilization and crop protection. Permanent grasslands were another important agricultural land cover in the studied landscapes, especially for livestock farming.

In order to sample insect biodiversity, we used pitfall and flight traps (Figure 11), which were always set together at each sampling site. Trap sets were placed with at least 30 m to the land parcel border to limit edge effects. For sampling ground-dwelling insects, carabids and spiders, we placed one pitfall trap per cereal field and grassland (McCravy 2018) (Figure 10d). The pitfall traps had 10 cm diameter and were half-filled with a 50 % propylene glycol solution. A drop of detergent was added to reduce surface tension and thus prevent the escape of lighter carabid species. Polystyrene roofs (22 cm diameter) were set about 5 cm above each trap to prevent flooding of traps during rainfall events.

In order to sample flying insects, we set flight sticky traps (Figure 10e). We wanted our trap to be neither attractive nor directional, though most traps used to sample pollinators cumulate both characteristics. The transparent interceptor trap is the best to sample pollinators such as hover flies or bees (Muirhead-Thompson 2012). We thereby modified the classic transparent interceptor trap in order to fit our sampling objectives, plus having a lighter design to prevent destruction from agricultural practices. Interceptors were transparent sheets (A3, 42 cm wide and 59.4 cm high) rolled into cylinders in order to catch insects coming from any direction. Transparency of the interceptor responded to the necessity of non-attractivity. The sheet was coated with glue to trap insects.

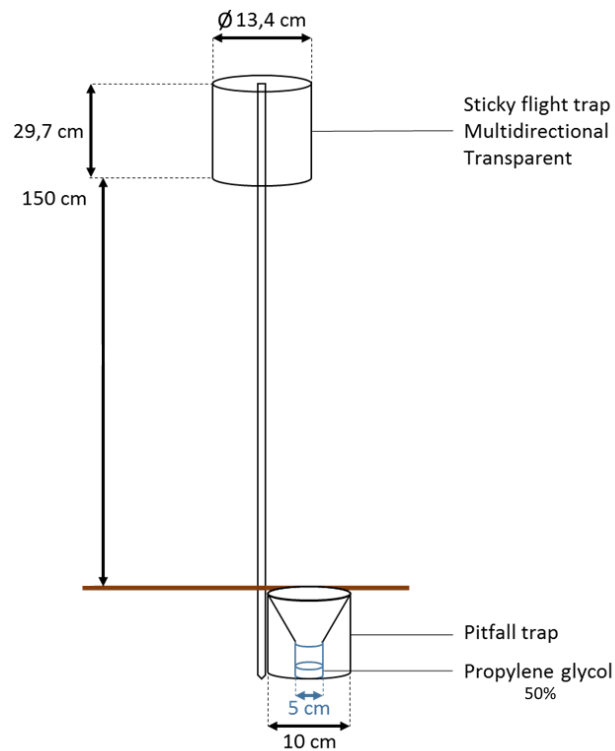
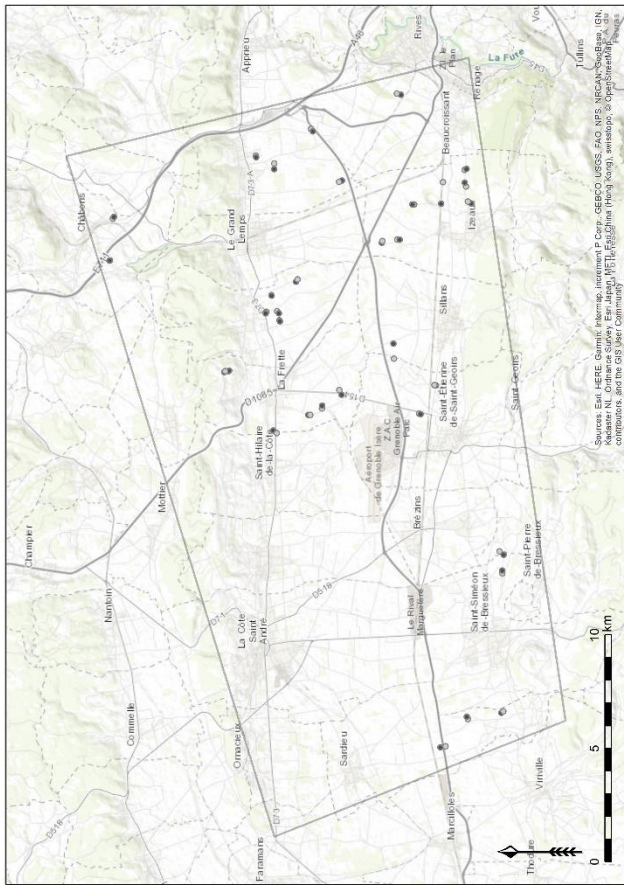
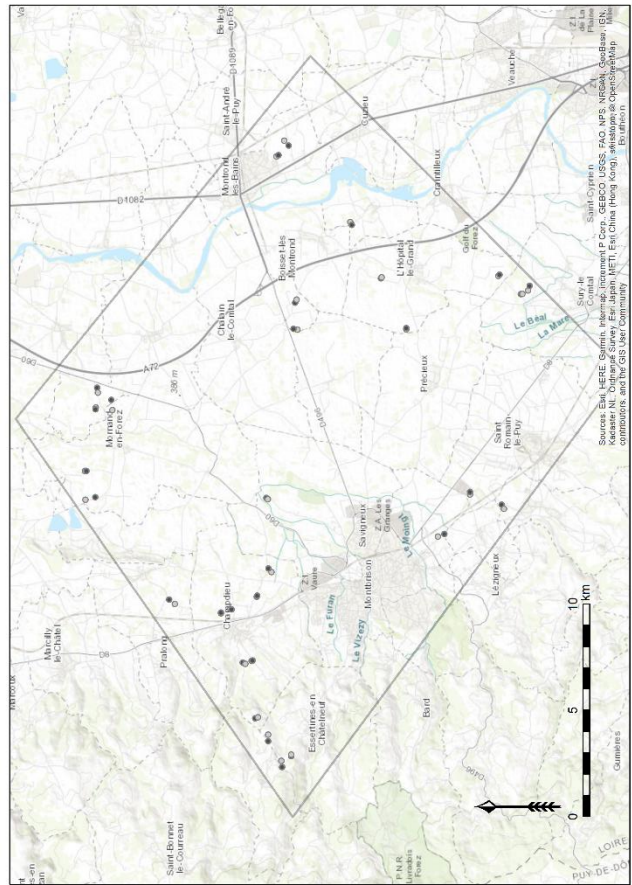

Figure 11. Paired flight and pitfall traps

In 2017, 84 sites were sampled, with 43 cereal fields and 41 nearby grasslands. In 2018, there were 122 sites sampled with 61 cereal fields and 61 grasslands. We had two more samples in cereal fields than in grasslands due to the destruction of two traps by cattle. Overall, we sampled insects in 205 different fields, always in pairs of grassland-cereal crop Figure 12. Each year, two field surveys were carried out with sampling periods of seven days. First period was between late April and early May, and second between late May and early June so that we could catch the most representative samples of spring breeding carabids. Each trap was thus open seven days twice per year. Species identification followed the keys of Jeannel (1942, 1941) and Coulon et al. (2011). Identification of spiders followed the keys of Nentwig et al. (2017). Hover flies and lacewings were identified at the family level following Villenave-Chasset (2017).



(a)



(b)

(c)

Legend
Sampled traps
 ● Cereal crop
 ● Permanent grassland
 □ Study region

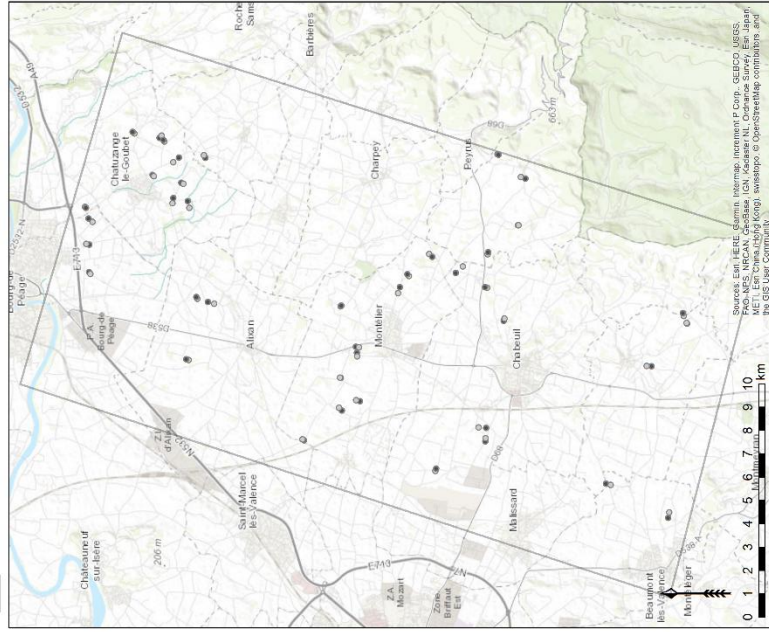

Figure 12. Locations of sampled traps in cereal crops and permanent grasslands per study region: (a) Bièvre, (b) Forez and (c) Rovaltain.

2.3. Statistical analyses

2.3.1. Biodiversity indicators

2.3.1.1. Carabid diversity and abundance

We selected three different species diversity indicators (DeJong 1975): (i) species richness, determined by the number of different recorded species in each field, (ii) activity-density, which is the headcount of every individual sampled per field, and (iii) evenness through Pielou's index. In order to investigate carabid data, we used common species richness indicators: α , β and γ . Alpha diversity represents the number of carabid species within each sampling site, whereas gamma diversity is related to the total number of species in each of the three study regions (Whittaker 1972). Beta diversity describes the common species ratio between paired cereal and grassland sampled sites (Whittaker 1972). We used Sørensen similarity index as beta diversity (Cardoso et al. 2009) with $\beta = \frac{2c}{S_1 + S_2}$ where c is the common species richness between the two paired sampled sites, and S_1 and S_2 the species richness of each site, in our case paired cereal field and grassland. Evenness was quantified using Pielou's index: $J' = H'/H'_{max}$ where H' is the observed Shannon diversity index and H'_{max} is the maximum value of Shannon, given the number of species per sample, meaning that all the sampled species were equally distributed: $H'_{max} = \ln S$, where S is the species richness. Shannon diversity index is calculated as follows: $H' = -\sum_{i=1}^n p_i \ln p_i$ where p_i is the proportional activity-density of the i^{th} taxon among the n species of the assemblage. For determining Pielou's evenness, samples where none or only one species had been caught were removed from the analysis, since the evenness indicator only relevant when there are at least two species. We grouped the sampling data of the first and the second sampling period in order to summarize the whole diversity of carabids present each year in spring.

2.3.1.2. Other sampled arthropod diversity and abundance indicators

For spiders, we studied the per trap family richness and activity-density we sampled in the permanent grasslands and in the cereal crops. Concerning pollinators, we counted the abundance of hover flies and lacewings caught on the sticky flight trap per field. We grouped the sampling data of the first and the second sampling periods in order to summarize the whole diversity of carabids present each year in spring.

2.3.2. Field and landscape parameters

The sampled field was described through three parameters: its land cover type, cereal crop or permanent grassland, its size and its shape index (Table 2). The shape index was computed as the ratio between the actual perimeter of the field and the perimeter of a square that would be the same size.

Table 2. Parameters used to describe the sampled fields in the statistical analyses

Variable	Type	Values / Metric
Land cover type	Qualitative	Winter cereal crop (WC) / Permanent grassland (PG)
Field size	Continuous	Hectares (ha)
Complexity shape index	Continuous	Double

All the landscape parameters are the results of field recording within a radius of 500 meters around every sampled site. We processed our data through ArcGIS 10.4 (Esri 2015) in order to obtain different landscape indicators for three different landscape radii (200, 300, 500 m) around the sampling points (Figure 13). To analyze the compositional heterogeneity of the landscape we applied the Shannon diversity index. It is calculated as follows: $H' = -\sum_{i=1}^n p_i \ln p_i$ where p_i is the proportional area of the i^{th} land cover among the n land covers in the corresponding radius areas around the sampling points. The land cover types which were considered for the Shannon index are presented in (Appendix A). The field border density, called in the following edge density, was measured by extracting the edges between land parcels and summing their total length in the three different radii areas. The winter crop-grassland edge density was obtained the same way, though it only considered the edges between adjacent parcels of winter crops and permanent grasslands.

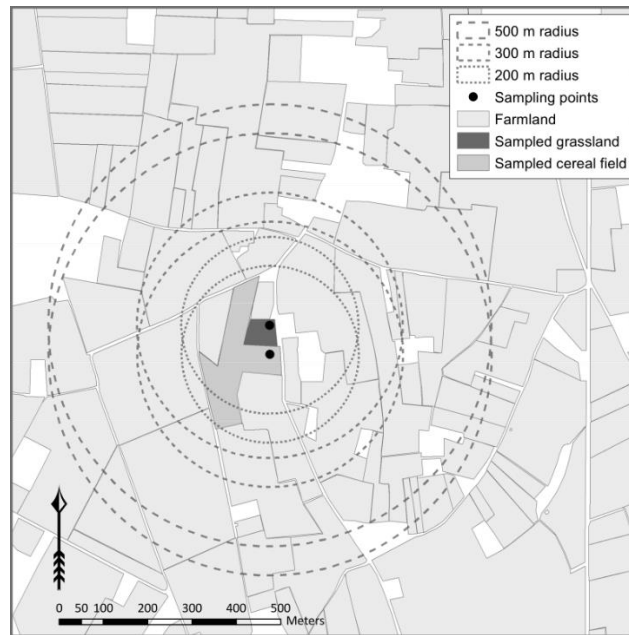

Figure 13. Different landscape context radii around the pairs of sampling points.

We performed a preliminary principal component analysis (PCA) with different landscape variables for the 200, 300 and 500 m radii areas around sampling points to determine the most explanatory variables as well as their correlation to other variables (Table 3). The PCA (Figure 14) then allowed the identification of a set of five variables which described best the landscape context (Appendix B and Table 3).

Table 3. Landscape parameters included in the preliminary PCA.

Landscape parameter	Formula (always applied within the landscape radius)
Annual winter crop coverage ratio	Annual winter crop area / landscape radius area
Annual spring crop coverage ratio	Annual spring crop area / landscape radius area
Permanent grassland coverage ratio ¹	Permanent grassland area / landscape radius area
Woodland coverage ratio	Woodland area / landscape radius area
Hedgerow coverage ratio ¹	Hedgerow area / landscape radius area
Crop diversity	Number of different crops
Landscape Shannon diversity ¹	$H' = -\sum_{i=1}^n p_i \ln p_i$ including all land cover types ²
Crop Shannon diversity	$H' = -\sum_{i=1}^n p_i \ln p_i$ including only crop cover types ²
Mean field size	Mean of the sizes of all fields
Mean field complexity	For all fields: mean of actual field perimeter / same-sized square field perimeter
Overall edge density ¹	Edge density between all the fields
Winter crop / grassland edge density ¹	Edge density between winter crops and permanent grasslands

¹ Parameters retained for the GLM analyses

² The land cover types accounting for landscape Shannon index are presented in Appendix A

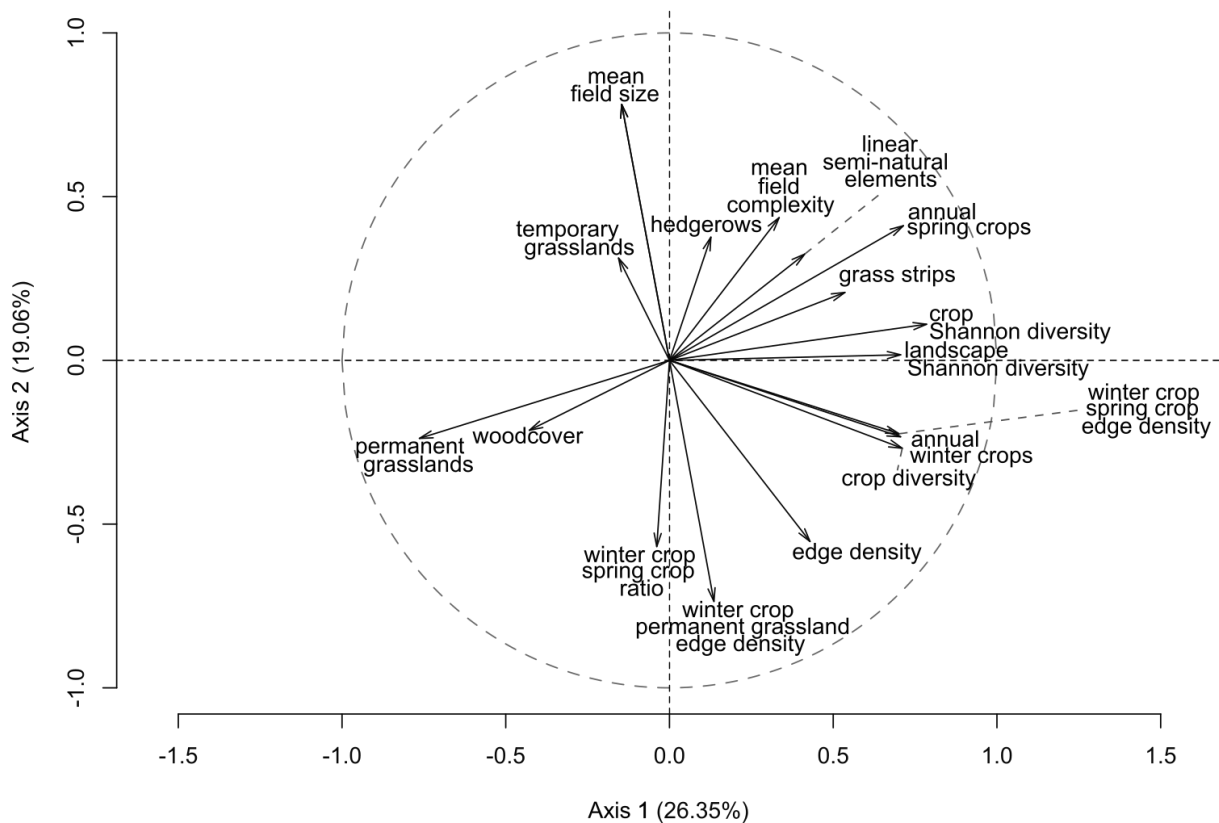

Figure 14. Preliminary PCA on landscape parameters first and second axes.

2.3.3. Generalized linear models (GLM)

We applied generalized linear models to study various diversity indicators, such as activity-density, species richness and evenness (Guisan et al. 2002; Bolker et al. 2009). Species richness models were fitted with Poisson distribution errors, activity-density with negative binomial distribution errors to account for overdispersion (Hoef and Boveng 2007; Lindén and Mäntyniemi 2011) and evenness with Gaussian distribution errors. When studying the commonness or exclusiveness of species, we fitted our models with binomial distributions errors (1 = common species, 0 = exclusive species).

Mixed effect was added when we analyzed both permanent grassland and cereal crops samplings. Indeed, the pair random effect was then added to the intercept to account for dependent covariations of biodiversity parameters between paired permanent grassland and cereal crop.

We used the Akaike Information Criterion corrected for small sample size (AIC_c) to select models offering the best compromise between fit and simplicity (i.e., the most parsimonious model) (Symonds and Moussalli 2011). In order to select the most parsimonious models, *i.e.* whose ΔAIC_c was inferior to 2 (Burnham and Anderson 2002; Burnham and Anderson 2004) and averaged them in order to retain as much information as possible on the significant explanatory variables (Burnham and Anderson 2002;

Johnson and Omland 2004). We always checked the null model ΔAIC_c to verify the significance of our model selection (a ΔAIC_c lower than 2 involved no significant effect of explanatory variable). We used R lme4 1.1-18-1 package (Bates et al. 2014) and the R MuMIn 1.42.1 package (Burnham and Anderson 2002; Barton 2018) for the multimodel inference procedure.

2.3.4. Mantel correlograms: spatial correlations of carabid assemblages

We applied Mantel correlations to compare the carabid assemblages of cereal crops and grasslands and analyzed them through Mantel correlograms (Legendre et al. 2005; Borcard and Legendre 2012). For all the Mantel correlograms analyses, we used R vegan 2.5-3 package (Oksanen et al., 2018). Mantel correlograms allowed to check the correlations of carabid assemblages between ecological distances and geographical distances. Assemblages from cereal crops were only compared to permanent grasslands, but not to other cereal sites, to assess similarity or dissimilarity between the two land cover types.

In order to estimate the ecological distances between our sampling sites, we first standardized our contingency tables according to Hellinger (Legendre and Gallagher 2001). We then applied classical Euclidean distances calculations to obtain the ecological distances matrix. Compared to Jaccard or Bray-Curtis distances, Hellinger offers the advantage to lower dissimilarity in case of rare species. Moreover, we determined geographical distances which were measured as the Euclidean distance between Lambert 93 coordinates of the sampled traps location. We only compared the samples from the same year in order to avoid any dissimilarity due to annual carabids assemblage variation.

2.3.5. Species distribution, traits and landscape context: RLQ multivariate analysis

In order to disentangle the relationship between landscape context, species distributions and life traits, we performed RLQ analyses (Dolédec et al. 1996; Dray et al. 2003; Kleyer et al. 2012). RLQ provides double ordination between three datasets: R (landscape context), L (carabids abundance contingency table) and Q (species traits). We standardized our abundance contingency tables according to Hellinger (Legendre and Gallagher 2001) and then applied classical Euclidean distances calculations to obtain the ecological distances matrix. Compared to Jaccard or Bray-Curtis distances, Hellinger offers the advantage to lower dissimilarity in the case of rare species (in the whole dataset).

RLQ recommends to firstly analyze all the tables separately with the appropriate multivariate ordination method: covariance analysis (CA) for the carabid contingency table. Secondly, principal correspondence analysis (PCA) was performed for the landscape context table. Thirdly, multiple correspondence analysis (MCA), by Hill-Smith PCA was driven for the trait table, weighing columns

with the previous PCA species scores. Finally, the RLQ analysis provides a combination of all three independent analyses. To test the robustness of the RLQ, we performed two Monte-Carlo randomization tests (Model 2 and 4, 9,999 permutations and $\alpha = 0.05$). For the first test, the null hypothesis was that species are distributed randomly across the sampled pairs, for the second test the null hypothesis was that species are distributed randomly, irrespectively to their traits (Dray and Legendre 2008; Duflot et al. 2014). We used the R ade4 1.7-13 package for the RLQ analysis (Dray et al., 2018).

3. Complementarity of grasslands and cereal fields ensures carabid regional diversity in French farmlands

Damien Massaloux^{a*}, Benoit Sarrazin^a, Anthony Roume^a, Vincent Tolon^a, Alexander Wezel^a

^a Isara, Agroecology and Environment research group, 23 rue Jean Baldassini, 69364 Lyon, France

This result chapter is currently under revision for a publication in Biodiversity Conservation.

3.1. Introduction

Farmland is the major land use in Europe and therefore strongly influences its biodiversity (Robinson and Sutherland 2002; Benton et al. 2003; Andersen 2017). Since the 1950's agricultural intensification and specialization have taken place (Robinson and Sutherland 2002; Bianchi et al. 2006). In western Europe, this resulted in the simplification of farmed landscapes with a reduction of land cover diversity, the enlargement of field size, and the removal of semi-natural landscape elements such as: hedgerows, vegetation strips, and woodland. Alongside this simplification, grasslands in agricultural areas have decreased as well, being abandoned or turned into croplands (Peeters 2012). Furthermore, because of the increase of meat production, grassland areas were also replaced by more intensive annual forage crops, such as silage maize (Huyghe 2009).

Current landscape context (composition and configuration) are linked to farming system changes, with intensification, specialization, and mechanization (Benton et al. 2003; Flohre et al. 2011; Tschardt et al. 2012a; Gámez-Virués et al. 2015). Therefore, agricultural landscapes are more influenced by human management which impacts the diversity and abundance of wildlife, including the beneficial species or groups that provide ecosystem services for farming activities. This results in a negative effect on biodiversity and ecosystem services such as biological control, pollination and nutrient recycling (Donald et al. 2000; Benton et al. 2002; Tschardt et al. 2012a; Emmerson et al. 2016; Dainese et al. 2017a).

The relationship between agricultural landscape contexts and biodiversity of beneficial entomofauna has been broadly studied, and a significant number focused on carabids (Mauremooto et al. 1995; Östman et al. 2001a; Aviron et al. 2005; Fahrig et al. 2015). Whereas they are part of ordinary biodiversity, meaning most of them are considered neither endangered nor rare, carabids (ground beetles) are important ecosystem services providers for crop production. Indeed, they contribute to pest regulation via biological control (DeBach and Rosen 1991; Kromp 1999; Bianchi et al. 2006; Dainese et al. 2017b) and weed regulation via consumption of weed seeds (Menalled et al. 2007;

Jonason et al. 2013; Trichard et al. 2013). These studies give evidence that landscape diversity has a positive impact on carabid diversity (Fahrig et al. 2011).

For this reason, grasslands are particularly important contributors to carabid diversity in cropland systems (Purtauf et al. 2005; Dufлот et al. 2017; Holland et al. 2017). Since crops are annually harvested, the spatial and temporal continuity of resource availability can be endangered in farmland. There is thereby a need for less disturbed land covers for carabids in agricultural landscapes to ensure shelter or forage (Roume et al. 2011; Gallé et al. 2018a). Although habitat is one major determinant of carabid assemblages (Thiele 1977; Kromp 1999), further knowledge on the convergence of carabid assemblages between neighboring non-crop and arable areas is still required. Such dispersal of carabids would highlight the landscape complementation theory (Dunning et al. 1992; Fahrig et al. 2011) as well as the cross-habitat spillover hypothesis (Tscharrntke et al. 2012b) and recommendations could be deduced for relevant stakeholders such as farmers, land planners and/or policy makers, creating a revalorization of grasslands or semi-natural open land cover, typical of diversified farming systems.

In this study, we evaluated the occurrence of carabid species in winter cereal and grassland fields from three agricultural plains. In these study regions the land cover was characterized by different levels of permanent grassland cover, inversely related to winter cereal cover. We investigated these two land cover types in neighboring paired fields. This protocol allowed us to look for spatial correlation of carabid assemblages despite contrasted sampled farmland cover types.

After an overall presentation of the carabid diversity, activity-density and evenness in the cereal crops and grasslands we sampled, we then focused on two objectives. First, we disentangled the relative effects of land cover types on carabid diversity and activity-density from local factors such as the size and shape of sampled fields, also including differences between the study regions. Secondly, we compared the similarity between carabid assemblages on cereal fields and grasslands, according to geographic distance. In this paper, we present the results of these analyses and discuss the complementarity of carabids assemblages between cereal crops and grasslands.

3.2. Material and Methods

3.2.1. Study regions

Our study was carried out in three agricultural plains of the Auvergne Rhône-Alpes region in southeastern France. The three study regions, Forez, Bièvre and Rovaltain are dominated by

conventional farming. Like in other parts of France, crop management is characterized by tillage practices (mostly between 20 and 25 cm deep) (Labreuche et al. 2011), chemical fertilization, as well as preventive application of pesticides, fungicides and herbicides (Butault et al. 2011). On arable land, spring crops and winter cereals occupy almost the same proportion. However, the three study regions had various proportions of grassland and winter cereal field (Table 4). The Forez study region is covered by 27% of permanent grasslands, while Bièvre by 16% and Rovaltain by only 3%. The major winter cereals were wheat and barley. Spring crops were maize, sunflower and soybean. Average field size was 1.96 ha in Bièvre study region, 2.06 ha in Rovaltain and 2.89 ha in Forez. Typically, winter cereals are sown in fall and harvested in June and July while spring crops are sown in April and May and harvested during late September and October. Winter cereals are cropped with at least one precautionary herbicide spraying, before or after winter, and one fungicide during spring. The use of pesticides can be more intense and variable according to annual and local climate conditions. Permanent grasslands are mowed two or three times in summer and sometimes also grazed. Relative woodland coverage is almost the same in Rovaltain and Forez, whereas in Bièvre it is slightly higher.

Table 4. Land cover characteristics of the three study regions in southeastern France.

Study region	Whole study region		Farmland ^b		Winter cereals		Spring crops		Other farmland ^a		Permanent grasslands		Woodland ^c	
	ha	%	ha	%	ha	%	ha	%	ha	%	ha	%	ha	%
Rovaltain	23,030	100	15,550	68	6,070	26	5,010	22	3,873	17	597	3	2,672	12
Bièvre	23,949	100	15,363	64	4,389	18	4,034	17	3,153	13	3,787	16	3,779	16
Forez	25,002	100	15,555	62	2,428	8	2,634	11	3,745	15	6,749	27	2,729	11

^a By importance of area: temporary grasslands, rapeseed, orchards and vineyards

^b Including temporary and permanent grasslands

^c Forests, woods and groves

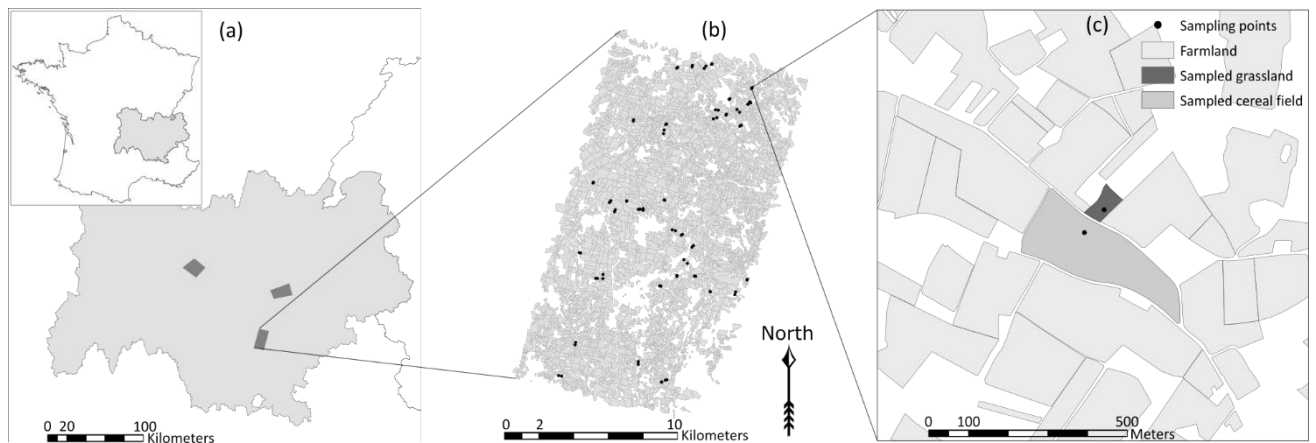

Figure 15. Locations of (a) the three study regions in the Auvergne Rhône-Alpes region, France, (b) sampling points (either cereal field or grassland) in the Rovaltain study region, and (c) example of sampling sites in neighboring paired cereal fields and grasslands.

3.2.2. Site selection and carabid sampling

We selected two contrasting agricultural land cover types corresponding to different intensities of management and inputs: winter cereals and permanent grasslands. Winter cereals were the most among croplands when considering the three study regions (Table 4). Sampled cereal fields were primarily cropped with wheat and barley and in a few cases with triticale and rye. Most fields were tilled and farmed with synthetic inputs. Another important agricultural landscape in this study were permanent grasslands, these are especially important for livestock farming. For analyzing carabid occurrences, we placed one pitfall trap per cereal field and grassland.

As we wanted to study similarities of species assemblages in the two contrasted land covers, we selected couples of sampling sites where cereal and grassland fields were adjacent or in close vicinity, the distance between paired samples ranging between 60 and 300 m with a median of 90 m. This vicinity allowed for similar landscape context. In 2017, 84 sites were sampled, with 43 cereal fields and 41 nearby grasslands. In 2018, there were 122 sites sampled with 61 cereal fields and 61 grasslands. We had two more samples in cereal fields than in grasslands due to the destruction of our traps by cattle; in this case, they were removed from any paired analysis. Carabids were sampled with pitfall traps (10 cm diameter) half-filled with a 50% propylene glycol solution. A drop of detergent was added to reduce surface tension and then prevent the escape of light carabid species. Polystyrene roofs (22 cm diameter) were set about 5 cm above each trap to prevent flooding of traps during rainfall events. The traps were set with at least 30 m to the field border to limit edge effects. Each year, two field surveys were carried out with sampling periods of seven days. The first period was between late April and early May, and the second was between late May and early June. Our sampling effort gave priority

to a higher number of sample sites per study region to get larger diversity of situation of carabids in pairs of cereal fields and grasslands, on the restriction of only two dates to be sampled per plot. However, the sampling of carabids in winter cereal is commonly done in spring and early summer (Hatten et al. 2007; Batáry et al. 2008; Anjum-Zubair et al. 2015; Bertrand et al. 2016), so that it corresponds to the high vegetational period of cereal crops. Therefore, we are not aiming at determining any peak of carabids activity-density per plot nor full representativeness of population, but at giving larger insight about the differences between cereal and grassland carabid assemblages. Species identification followed the keys of Jeannel (1941, 1942) and Coulon et al. (2011).

3.2.3. Data analysis

3.2.3.1. Carabid diversity and activity-density indicators

For data analysis, we selected three different species diversity indicators (DeJong 1975): (i) species richness, determined by the number of different recorded species in each field, (ii) activity-density, which is the headcount of every individual sampled per field, and (iii) evenness through Pielou's index. In order to investigate carabid data, we used common species richness indicators: α , β and γ . Alpha diversity represents the number of carabid species within each sampling site, whereas gamma diversity is related to the total number of species in each of the three study regions (Whittaker 1972). Beta diversity describes the common species ratio between paired cereal and grassland sampled sites (Whittaker 1972). We used Sørensen similarity index as beta diversity (Cardoso et al. 2009) with $\beta = \frac{2c}{S_1 + S_2}$ where c is the common species richness between the two paired sampled sites, and S_1 and S_2 the species richness of each site, in our case paired cereal field and grassland. Evenness was quantified using Pielou's index: $J' = H'/H'_{max}$ where H' is the observed Shannon diversity index and H'_{max} is the maximum value of Shannon, given the number of species per sample, meaning that all the sampled species were equally distributed: $H'_{max} = \ln S$, where S is the species richness. Shannon diversity index is calculated as follows: $H' = -\sum_{i=1}^n p_i \ln p_i$ where p_i is the proportional activity-density of the i^{th} taxon among the n species of the assemblage. For determining Pielou's evenness, samples where none or only one species had been caught were removed from the analysis, since the evenness indicator only relevant when there are at least two species. We grouped the sampling data of the first and the second sampling period in order to summarize the whole diversity of carabids present each year in spring.

3.2.3.2. Statistical analyses

Statistical analyses were conducted using R 3.5.0 (R Development Core Team 2018). We first compared the distributions of the three carabid richness indicators between winter cereal crops and permanent

grasslands. We drove a Whitney-Mann-Wilcoxon non-parametric test to compare indicator means and a variance test (Bradley-Ansari) to compare their dispersion. Spearman's rank tests were run between species richness in cereal crops and grasslands to show any possible covariations between the two land cover types among sites.

Second, in order to deepen the per sample variability, analysis of carabid species richness, activity-density and evenness, we tested the correlation of sampled field and land cover type parameters (Table 2) using mixed-effect generalized linear model inference (Guisan et al. 2002; Bolker et al. 2009). We computed the field size and a shape index as the ratio between the actual perimeter of the field and the perimeter of a square that would be the same size. These two continuous geometric variables were not significantly correlated (Spearman's rank correlation p-value > 0.1 and rho = 0.11), therefore, both were kept in our model sets.

For every indicator, twenty-one different generalized linear models were fitted. The full model included additive terms of the three explanatory parameters (Appendix B), to which we added the interactions of land cover type with the sampled field size, study region and year respectively. Concerning the study region and the year of sampling, they could not be included in the models as random effects, since they had too few different levels. Thereby, we computed this two parameters as fixed effects (Bolker et al. 2009). A sampling pair site random effect was finally systematically added to the intercept to account for dependent covariations of biodiversity parameters between paired permanent grassland and cereal crop. The null model included only the study region, the year and the pair site random effect. Species richness was fitted with Poisson distribution errors, activity-density with negative binomial distribution errors to account for overdispersion (Hoef and Boveng 2007; Lindén and Mäntyniemi 2011) and evenness with Gaussian distribution errors.

We used the Akaike Information Criterion to correct for the small sample size (AIC_c) and select models offering the best compromise between fit and simplicity (i.e. the most parsimonious model) (Symonds and Moussalli 2011). For each biodiversity indicator we selected the most parsimonious models, *i.e.* whose ΔAIC_c was inferior to 2 (Burnham and Anderson 2002, 2004; Burnham et al. 2011) and averaged them in order to retain as much information as possible on the significant explanatory variables (Burnham and Anderson 2002; Johnson and Omland 2004). We always checked the null model ΔAIC_c to verify the significance of our model selection (a ΔAIC_c lower than 2 involved no significant effect of explanatory variable, Appendix C).

3.2.3.3. Spatial correlations of carabid assemblages between the two land covers

We applied Mantel correlations to compare the carabid assemblages of cereal crops and grasslands and analyzed them through Mantel correlograms (Legendre et al. 2005; Borcard and Legendre 2012). For all the Mantel correlograms analyses, we used R vegan 2.5-3 package (Oksanen et al., 2018). Mantel correlograms allowed to check the correlations of carabid assemblages between ecological distances and geographical distances. Assemblages from cereal crops were only compared to permanent grasslands, but not to other cereal sites, to assess similarity or dissimilarity between the two land cover types.

In order to estimate the ecological distances between our sampling sites, we first standardized our contingency tables according to Hellinger (Legendre and Gallagher 2001). We then applied classical Euclidean distances calculations to obtain the ecological distances matrix. Compared to Jaccard or Bray-Curtis distances, Hellinger offered the advantage to lower dissimilarity in the case of rare species (in the whole dataset). Then, we determined geographical distances which were measured as the Euclidean distance between Lambert 93 coordinates of the sampled traps location. We only compared the samples from the same year in order to avoid any dissimilarity due to annual carabids assemblage variation. We applied the Mantel correlograms to the three study regions together, and then to every region individually.

3.3. Results

3.3.1. Species richness in winter cereal and permanent grassland

A total of 115 different carabid species (Appendix D) were caught with 5,644 individuals (Table 5). In cereal fields, 82 different species were sampled and 95 in grasslands. Although the Forez region was the least sampled area, it had the highest relative species richness with 90 species compared to the other two study regions. Species exclusively found in cereal fields were 20, for grasslands it was 33 species. Mean species richness and activity-density were lower in Rovaltain than in the two other study regions.

Overall species richness was higher in all permanent grasslands compared to all cereal crops, but we did not sample more species in grasslands per site (Table 5). According to variance analysis through Ansari-Bradley tests, species richness values were more dispersed among grassland samples than among cereal ones. Carabids activity-density between paired sites showed a significantly higher activity-density in cereal fields than in permanent grasslands. The variance analysis, however, showed

that dispersions of activity-density and evenness were not different between the two land covers (Table 5).

Common species richness in paired cereal fields and grasslands consisted of about 24% of the species, the rest were species only found in one of the paired land covers (Table 5). Rovaltain showed fewer common species and a lower percentage between paired sites than Bièvre or Forez. Beta diversity was also lower in Rovaltain. Although there were similar numbers of exclusive species in both land covers in Rovaltain and Forez areas, it was different in Bièvre area where more species were found in cereal fields than grasslands.

Table 5. Species richness of carabid beetles in winter cereal and permanent grasslands in three agricultural areas of southeastern France.

	Number of sampled sites	Total species richness (γ)	Species richness ^a per site (α) ^b Mean \pm SD	Common species of paired sites Mean \pm SD	Exclusive species in paired sites Mean \pm SD	β diversity of paired sites Mean \pm SD	Total activity- density ^a (individuals) in sites	Activity- density ^a per site Mean \pm SD	Evenness ^a per site Mean \pm SD
All study regions									
Winter cereal	104	82	7.0 \pm 3.4		5.4 \pm 2.7		3,612	35 \pm 35	0.75 \pm .16
Perm. grassland	102	95	6.5 \pm 4.4	1.6 \pm 1.8	4.9 \pm 3.5	0.2 \pm .2	2,032	20 \pm 31	0.87 \pm .14
Overall	206	115	6.8 \pm 3.9		-		5,644	27 \pm 34	0.81 \pm .16
Rovaltain									
Winter cereal	41	44	4.9 \pm 2.7		4.1 \pm 2.4		755	18 \pm 17	0.79 \pm .15
Perm. grassland	41	49	4.7 \pm 3.7	0.8 \pm 1.0	3.9 \pm 3.1	0.2 \pm .2	661	16 \pm 41	0.88 \pm .17
Overall	82	69	4.8 \pm 3.2		-		1,416	17 \pm 31	0.83 \pm .17
Bièvre									
Winter cereal	33	48	8.1 \pm 3.1		6.1 \pm 2.8		1,646	50 \pm 45	0.73 \pm .15
Perm. grassland	32	52	6.9 \pm 3.9	2.0 \pm 1.9	4.8 \pm 3.4	0.3 \pm .2	663	21 \pm 22	0.87 \pm .12
Overall	65	70	7.5 \pm 3.6		-		2,309	36 \pm 38	0.80 \pm .15
Forez									
Winter cereal	30	61	8.7 \pm 3.1		6.4 \pm 2.4		1,211	40 \pm 30	0.73 \pm .16
Perm. grassland	29	70	8.7 \pm 4.9	2.3 \pm 2.2	6.4 \pm 3.8	0.2 \pm .2	708	24 \pm 23	0.85 \pm .11
Overall	59	90	8.7 \pm 4.0		-		1,919	36 \pm 38	0.79 \pm .15
	Ansari Bradley test ^c		*	Ansari Bradley test ^c			p > 0.1	p > 0.1	
	Paired Mann Whitney Wilcoxon test ^d		p > 0.1	Paired Mann Whitney Wilcoxon test ^d			***	***	

^a summed over twice sampling per year

^b average value per sampling site

^c between permanent grassland and cereal crop distributions

^d between paired grassland and cereal crop samples

Table 6. Most abundant species in (a) winter cereal crops, and (b) permanent grasslands in the three study regions of southeastern France.

(a)				(b)			
Species	Rank	Activity-density (%)	Cumulative activity-density (%)	Species	Rank	Activity-density (%)	Cumulative activity-density (%)
<i>Poecilus cupreus</i>	1	37	37	<i>Harpalus dimidiatus</i>	1	9	9
<i>Anchomenus dorsalis</i>	2	26	63	<i>Harpalus anxius</i>	2	8	17
<i>Trechus quadristriatus</i>	3	5	68	<i>Amara aenea</i>	3	8	25
<i>Metallina lampros</i>	4	4	72	<i>Metallina properans</i>	4	8	32
<i>Pterostichus melanarius</i>	5	3	75	<i>Anchomenus dorsalis</i>	5	6	39
<i>Harpalus affinis</i>	6	3	79	<i>Poecilus cupreus</i>	6	5	44
<i>Carabus auratus</i>	7	2	80	<i>Poecilus versicolor</i>	7	5	48
<i>Harpalus distinguendus</i>	8	1	82	<i>Metallina lampros</i>	8	4	53
<i>Harpalus dimidiatus</i>	9	1	83	<i>Amara fulvipes</i>	9	3	56
<i>Harpalus tardus</i>	10	1	84	<i>Harpalus serripes</i>	10	2	58

The evenness of species in grasslands were higher than in cereals. Only two species were necessary to reach 50% of individuals sampled in cereal fields, and five to reach 75% (Table 6). *Poecilus cupreus* represented almost 37% of the individuals sampled in cereal fields, but only 5% in grasslands. In contrast to cereal fields, eight species were necessary to reach 50% of total activity-density in grasslands (Table 6). 20 species were necessary to reach 75% of all sampled individuals in grasslands, indicating a much less pronounced dominance of some species compared to the cereals. *Harpalus dimidiatus*, the most abundant species in grasslands, represented 9% of the total, and three other species, *H. anxius*, *Amara aenea*, *Metallina properans*, were almost just as numerous.

Considering both land cover types, assemblages were dominated by five species: *P. cupreus*, *A. dorsalis*, *H. dimidiatus*, *M. properans* and *Trechus quadristriatus* (Appendix E). They were always the top ten most abundant species of every study region. *P. cupreus* and *A. dorsalis* were always the two most sampled species per study region. We did not sample any vulnerable nor endangered species according to the International Union for Conservation of Nature's Red List of Threatened Species (IUCN French Committee 2019).

3.3.2. Carabid diversity: study region context and field parameters combined effects

The mixed effect generalized linear model analysis showed that species richness was only significantly explained by the study region, evenness by land cover type, where activity-density was described by a more complex model with the important factors of: study region, land cover type, and sampling year (Appendix F). Rovaltain showed the lowest levels of species richness per sampled site and no significant

difference appeared through the multimodel inference between Bièvre and Forez (Figure 16a). The generalized model analysis confirmed that activity-density was higher in cereal crops; though it showed that this was less the case in the Rovaltain study region (Figure 16b). Activity-density was higher in small cereal fields compared to grasslands, then became more similar in fields larger than 10 ha (Figure 16c). Finally, a significant difference for evenness was found in the carabid assemblages, being more evenly distributed in grasslands than in cereal crops (Figure 16d).

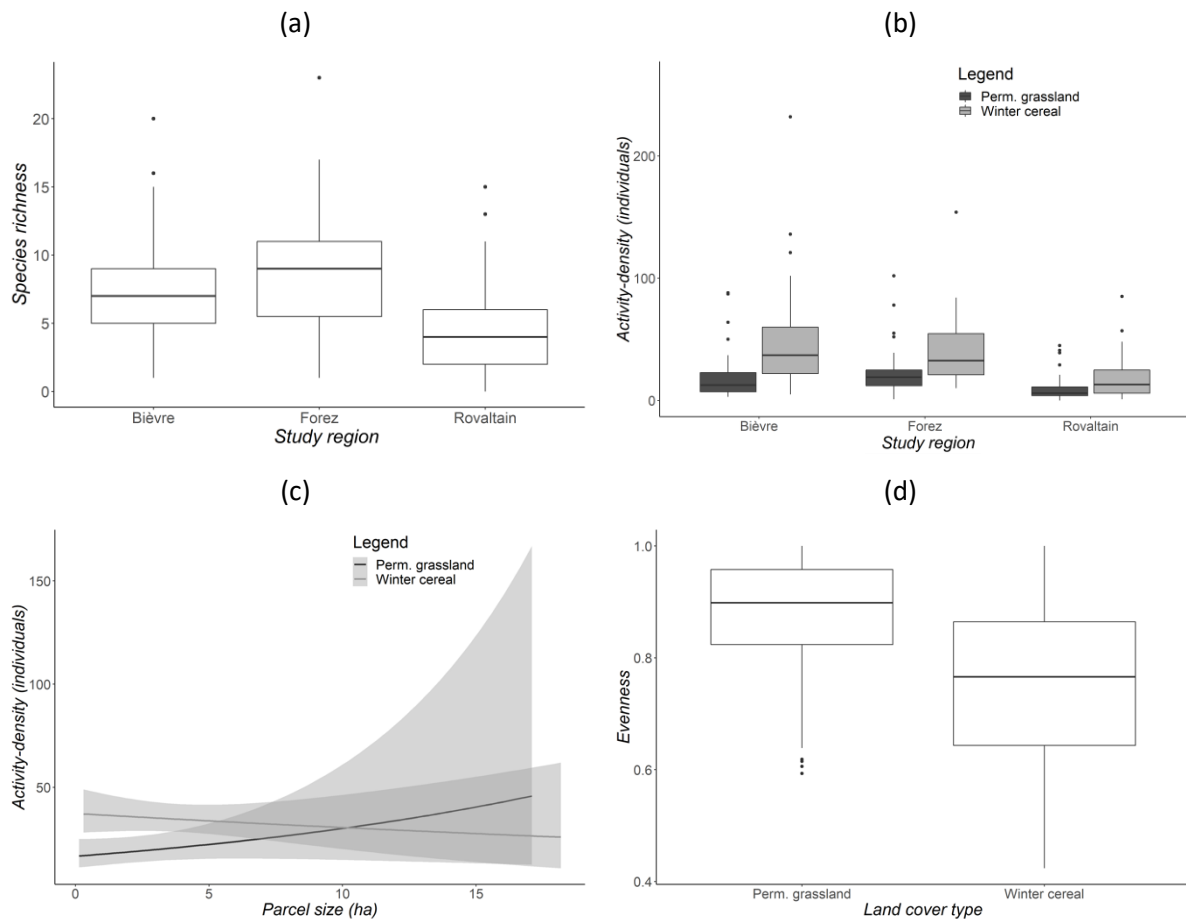

Figure 16. Significant parameters and interactions effects of multivariate model analysis in the three study regions: (a) species richness explained by study region, (b) study region and land cover type, (c) permanent grassland and field size, and (d) evenness.

Note: In boxplots, symbols are: middle line=median; open rectangle=25-75% quartile; vertical bar=non-outlier range; black points=outliers. In line chart 2d, area around the curve is the 0.95 margin error.

3.3.3. Spatial correlation of carabid assemblage in differentiated land covers

Assemblages of carabid species in cereal crop and grassland were more likely to be similar when their site locations were closer and in the same study region. The Mantel correlograms showed correlations between ecological and geographical distances by distance categories per study region (Table 7). Both Bièvre and Forez presented significant similarities between paired cereal fields and grasslands for a distance less than to 0.3 km, whereas this was not the case for Rovaltain. Furthermore, the similarity was confirmed under 1 km distance for the Forez area, however, we noticed also significant dissimilarity between 1 to 3 km.

Table 7 Mantel correlation between permanent grasslands and cereal fields carabid assemblages.

Distance categories (km)	Rovaltain		Bièvre		Forez	
	Mantel signature	signif.	Mantel signature	signif.	Mantel signature	signif.
0 - 0.3	+	ns	+	**	+	**
0.3 - 1	+	ns	+	ns	+	*
1 - 3	+	ns	-	ns	-	*
3 - 4	-	ns	+	ns	-	ns
4 - 5.5	-	ns	+	ns	-	ns
5.5 - 7	+	ns	-	ns	-	ns
7 - 8.5	+	ns	-	ns	+	ns
8.5 - 10	-	ns	-	ns	-	ns
10 - 13	-	ns	-	ns	+	ns
13 - 22	+	ns	+	ns	-	ns

Note: not only assemblages of paired sites were compared (except of 0 - 0.3 km), e.g. a cereal field assemblage was compared to those of all other grassland sites located in a given distance category.

Mantel signature: positive means similarity; negative means dissimilarity. ns = non-significant.

When we considered only distance classes where the Mantel correlation was significant (Figure 17), grasslands and cereal crops showed a decrease of Sørensen beta diversity when the distance between them became higher. Closely located paired grasslands and cereal crops had a mean beta diversity of 0.2, whereas beta diversity between a cereal field and other grassland sites was lower.

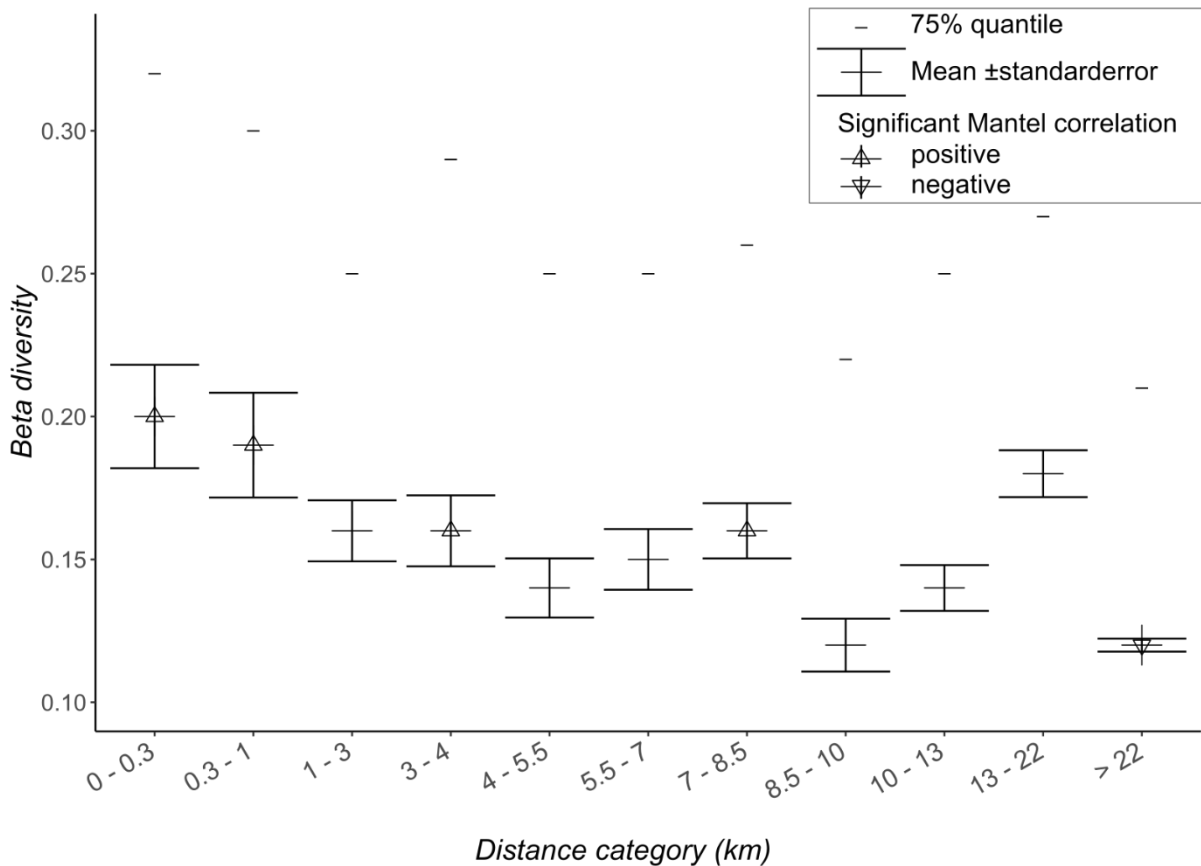

Figure 17. Sørensen beta diversity of cereal field and grassland in all three study regions per class of distance.

Note: comparison is for paired sites (0 - 0.3 km), between a cereal field and other grassland sites located in the same study region (0.3 - 22 km), and with another study region (> 22 km).

3.4. Discussion

In this study, we analyzed carabid diversity and the activity-density of cereal fields and grassland, sampled as neighboring pairs in three agricultural plains. Lower species richness and activity-density were found in the study region with lower grassland coverage. More carabids were sampled in cereal fields smaller than 10 hectares. Evenness of carabid assemblages was higher in grasslands. We also observed that assemblages were slightly but significantly more similar when cereal crops and grasslands were located closer to each other, up to a distance of 4 km.

3.4.1. Grassland and cereal crop carabid assemblages

Our results showed many differences between the carabid assemblages of cereal fields and grasslands. Despite similar per site species richness in the two land cover types, we found an overall higher species richness in permanent grasslands than in cereal fields. This is contrasting with other results (Dauber et

al. 2005; Vician et al. 2015). We sampled more grasslands, in larger study regions, which were located farther from one another. Hence, the grasslands we sampled were more likely to be heterogeneous, being under more various pedoclimatic conditions. This variety of conditions also involves different management practices (Taugourdeau et al. 2012), impacting the grassland plant species composition as well (Plantureux et al. 2012). This increases heterogeneity among the grasslands, which could result in an overall higher carabid species richness in this land cover type (Melnychuk et al. 2003; Grandchamp et al. 2005; Schaffers et al. 2008), whereas ecological conditions are more homogeneous in cereal fields.

Carabid assemblages were more evenly distributed in grasslands than in cereal crops. Such land cover type is less disturbed and offers a wider range of habitats (Schaffers et al. 2008; Garcia-Tejero and Taboada 2016) as compared to more intensified and standardly-managed cereal crops. These features of grasslands can enhance their suitability for species with different levels of tolerance to disturbances and different habitat requirements. The lower evenness in cereal crops we found were mainly due to the dominance of *P. cupreus* and *A. dorsalis*, also observed by Bertrand *et al.* (2016) in western France and Baranová *et al.* (2013) in Slovakia. These two species are known to be dominant in arable land during spring (Baranová et al. 2013; Bertrand et al. 2016; Lemic et al. 2017). In cropland, it is common to find assemblages mainly dominated by a few species, which share a high tolerance to anthropogenic disturbances (Thiele 1977; Luff 1996; Kromp 1999).

The strong dominance of these two species mainly accounted for the higher activity-density observed in cereal crops. This became more evident in fields up to 10 ha large. The lower activity-density in larger cereal fields, compared to grasslands, could be related to more intense practices therefore, reducing the habitat suitability for carabids (Holland and Luff 2000). Larger cropped fields are typical for simplified agricultural landscapes where semi-natural elements have been removed and these semi-natural elements are beneficial to carabids (Dauber et al. 2005; Purtauf et al. 2005; Burel and Baudry 2005; Duflot et al. 2017). Furthermore, smaller crop fields host higher diversity (Fahrig et al. 2015), giving higher access to their borders, easing the movement of organisms between different habitats. Larger grasslands with a size above 10 ha have on the contrary higher activity density. They can provide a wider diversity of microhabitats suited for rarer species and thus increase the grassland assemblage (Garcia-Tejero and Taboada 2016).

Dauber *et al.* (2005) and Vician et al. (2015) also recorded a higher activity-density in cereal crops than in grasslands. However, it is known that pitfall traps efficiency is lower when the herbaceous cover is denser (Lang 2000), which could potentially underestimate the actual species richness and activity-density in grasslands, more than in crops (Melbourne 1999; Koivula et al. 2003).

We found no significant relationship between the field shape and the area of carabid species richness and evenness. This might be related to our sampling design. It would be more precise to sample in different locations on the field for example, in the center and near different borders, to check the effects of field shape and area.

3.4.2. Similarities in carabid assemblages between cereal fields and grasslands

Our first objective was to evaluate the extent in which neighboring cereal and grassland assemblages show similarities. Within each study region, species composition showed significant similarity between the two land cover types up to 4 km distance. Similarities between grasslands and cereal crops assemblages can be due to an ecological filtering of species at the landscape level (Duflot et al. 2014; Magura and Lovei 2019). Ecological filtering is the process where species are determined by habitat, environmental factors and ecological interactions (Magura et al. 2015), as opposed to random processes (Pausas and Verdú 2010). Hence, ecological filtering means that the similarity between grassland and cropland assemblages is not random but due to environmental factors. We found higher similarity in assemblages in grasslands and cereal crops within a 4 km radius. This demonstrates a change in the species pool when sampled grasslands and cereal fields are further than 4 km, this could be due to significant differences in landscape and/or pedoclimatic conditions. When the cereal field and the compared grasslands were not in the same study region, we observed a significant lower similarity between their assemblages indicating that carabid species pools are pre-determined at the regional level through pedoclimatic conditions, landscape composition and configuration, but also potentially by differences in farmland management.

3.4.3. Carabid assemblages and regional differences

Another objective of our study was to explain carabid diversity and activity-density by local factors, but also looking at differences between study regions. The regional context seems to influence species diversity, especially in Rovaltain the region with lowest per site species richness and activity-density. Furthermore, Rovaltain is the study region where we have the lowest proportion of grasslands and other semi-natural elements and higher proportions of arable lands. This relates well to other findings showing that a simpler farmland context and lower landscape heterogeneity negatively impacts carabid diversity (Dauber et al. 2005; Purtauf et al. 2005; Burel and Baudry 2005; Duflot et al. 2017). We found the highest species richness for the Forez region, whereas Rovaltain and Bièvre had almost the same overall numbers. Forez have the highest percentage of grassland of all study regions. However, Forez semi-natural woody areas have the same percentages as in Rovaltain; both relatively lower than in Bièvre. Woodlands of Bièvre and Rovaltain are concentrated on foothills, whereas in Forez they are scattered across the study region, increasing the heterogeneity of the landscapes.

Therefore, our findings support that the heterogeneity of the landscape mosaic benefits to regional species richness as reported by Barbaro and Halder (2009); Diekötter et al. (2008); and Duflot et al. (2016), relying on the mutually beneficial relationships between the carabid assemblages of cropland, grassland and woodland (Magura and Lovei 2019).

The overall 82 different species richness we found in cereal fields in the three study regions is higher than what was seen in similar research works: 68 in Baranová et al. (2013) and 58 in Bertrand et al. (2016). Our study regions' size is very similar to the whole sampling areas of these studies. When considering both land cover types, overall, we found 115 species. Rovaltain and Bièvre had 69 and 70 species, respectively, which was similar to 73 in Cole et al. (2002), while it was much higher with 90 in Forez. Nevertheless, Cole et al. (2002) sampled 61 different sites in a study region eight times larger than our three sites. Some other research shows higher species richness in cropped fields than ours, which might be explained by a much stronger sampling intensity through time (Diekötter et al. 2008; Duflot et al. 2017).

3.4.4. Complementarity and discrepancy of grassland and cropland in terms of carabid assemblages

We found beta diversity was at its highest in paired sampled sites, which could be explained by multiple factors. Firstly, it is possible that species which were common to both land cover types have larger habitat range, thus being suited to both habitats. *P. cupreus* and *A. dorsalis* are examples of such species. Secondly, carabid populations are known to migrate between cropland and grassland and vice-versa. When preys are lacking after crop harvest, there is a spillover of carabids from arable fields into neighboring grasslands (Schneider et al. 2016), where some of them overwinter (Holland et al. 2005; Gallé et al. 2018a) and eventually recolonize cropland in spring when conditions become suitable. Thirdly, some common species may need both cereal crop and grassland habitats for resource complementation (Fahrig et al. 2011; Duflot et al. 2017).

However, our results showed that mean beta diversity, the Sørensen similarity index, was only around 0.2 between paired cereal crops and grasslands, which is a relatively low value (Jost et al. 2011). Assemblages from the two land cover types thus remain strongly distinct, even when they are neighboring and statistically similar by Mantel correlations. This is further shown with a relatively large number of species found exclusively in either cereals or grasslands, 24% and 35% respectively. These results are in line with the common finding that habitat is one essential determinant of carabid assemblages, in particular between cropland and grassland (Thiele 1977; Luff 1996; Kromp 1999). The discrepancy between species composition of the two land cover types show that cropland and

grassland each have their own affiliated species. Hence, conservation of carabid diversity in farmland cannot depend only on the conservation of grasslands as some species are relying strongly on croplands. Here, management of the cropland plays a crucial role. Therefore, there is a need for beneficial farming practices for carabid diversity (Dainese et al. 2017b; Chabert and Sarthou 2017) in terms of soil tillage (Hatten et al. 2007; Shearin et al. 2007; Boscutti et al. 2015), organic farming practices (Melnychuk et al. 2003; Purtauf et al. 2005; Eyre et al. 2012; Gallé et al. 2018b; Djoudi et al. 2019), reduction of pesticides, (Lee et al. 2001b; Geiger et al. 2010) and implementation of flower and grass strips within a field (Menalled et al. 2001; Tschumi et al. 2015).

3.5. Conclusion

Our study shows complementarity of cereal fields and grasslands when it comes to enhance carabid richness, assemblages, and activity-density, both locally and regionally. Overall, a high number of species were found (115). Each of the two land cover types shelters a particular carabids assemblage, thus both cereal and grassland fields contribute to carabid diversity in farmland. The conservation and enhancement of carabid diversity thereby appears to be dependent on both cropped and semi-natural land cover types in agricultural landscapes. Their complementarity is spatiotemporal: they provide different and continuous resource to carabids, throughout the year.

Hence, to take advantage from the complementarity and differences of carabid diversity in cereal crops and grasslands in agricultural areas, farming activities, public policies and land planning need to consider abundance and spatial distribution of these two land cover types, hence allowing benefits for carabid biodiversity conservation in agricultural landscapes.

4 Landscape diversity and field border density enhance carabid diversity in adjacent grasslands and cereal fields

Damien Massaloux^a, Benoit Sarrazin^a, Anthony Roume^a, Vincent Tolon^a, Alexander Wezel^a

^a Isara, Agroecology and Environment research group, 23 rue Jean Baldassini, 69364 Lyon, France

This chapter is an original paper currently under review after revision at Landscape Ecology.

4.1 Introduction

Biodiversity is decreasing dramatically worldwide with land use change and degradation being among its major causes (Foley et al. 2005; IPBES 2018b). In Europe, this biodiversity loss is strongly related to the intensification of agriculture since the 1950's (IPBES 2018a). The intensification of agriculture took different forms: the increase of mono-cropping (Power and Follett 1987; Mudgal et al. 2010), the intensive use of insecticides, herbicides and fungicides as well as the specialization of farms (Robinson and Sutherland 2002; Mazoyer and Roudart 2006; Bianchi et al. 2006). Intensification of agriculture has also led to the homogenization of landscapes where only a few crops dominate, generally accompanied with an increase of field size (Benton et al. 2003; Flohre et al. 2011; Tschardt et al. 2012a; Gámez-Virúés et al. 2015). Natural and semi-natural landscape elements, such as hedgerows, vegetation strips and groves were thus withdrawn, while more and more grasslands were being cropped or abandoned (Peeters 2012).

The loss of biodiversity is indeed affecting ecosystem services in farmlands, such as biological control, pollination or nutrient recycling (Tschardt et al. 2012a; Emmerson et al. 2016; Dainese et al. 2017a; Landis 2017). Carabids (ground beetles) provide biological control through predation of aphids, slugs and snails (Kromp 1999; Bianchi et al. 2006; Dainese et al. 2017b), and weed regulation in consuming their seeds (Menalled et al. 2007; Jonason et al. 2013; Trichard et al. 2013).

Higher landscape heterogeneity, meaning both compositional, the diversity of land covers, and configurational, the complexity of patch shapes, increases carabid diversity (Fahrig et al. 2011; Fahrig et al. 2015; Madeira et al. 2016). In cropland, the proximity of grasslands and hedgerows is an important factor to enhance carabid diversity (Purtauf et al. 2005; Dufлот et al. 2017; Holland et al. 2017).

For grasslands, the impact of landscape heterogeneity on carabid species richness has been less investigated so far. Batáry et al., (2007) analyzed the influence of landscape parameters on carabid

species traits though not on carabid diversity They indeed focused on the habitat specialization trait of carabid species and found that the generalist diversity decreases with increasing grassland coverage, whereas grassland specialists increased. Most research works studied the impact of the management practices in grasslands on carabid species diversity, considering both grazing and mowing (Kruess and Tschardtke 2002; Grandchamp et al. 2005; Lyons et al. 2017).

In herbaceous or shrubby field margins, carabid species richness is higher with increased plant species diversity (Thomas and Marshall 1999). However, in field margins, the landscape context around impacts on carabid species but rather on community composition and abundance than on richness (Gallé et al. 2018a). The presence of more heterogeneous surroundings indeed favors spring-breeding species by providing them overwintering refuge habitats.

As croplands are disturbed habitats due to farming activities, their carabid communities may spillover into neighboring habitats, such as grasslands or other crops (Schneider et al. 2016), or even also migrate into grasslands for overwintering (Holland et al. 2005; Gallé et al. 2018a). Grasslands and croplands are major components of agricultural landscapes; moreover, grasslands can provide resource and habitat complementation to cropland carabid assemblages (Dunning et al. 1992; Pfiffner and Luka 2000; Fahrig et al. 2011).

Since the focus of most studies has been put on the carabid communities in one targeted habitat or on the gamma diversity from numerous habitats, compared carabid communities from crops and grasslands has been less investigated, as well as the relative influence of landscape heterogeneity on the carabid diversity of these two land cover types. Indeed, since grasslands are enhancers of carabid diversity in croplands and in a context of general grassland area decline (Peeters 2012), there is a need to enhance the knowledge about the potential synergistic interactions between grasslands and cereal crops concerning beneficial biodiversity for agriculture such as carabids.

We thereby focused our work on three agricultural plains where the farmlands are structurally important in the landscape (between 60 and 70 % of the study region). Thus, we aim at contributing to applied agroecological knowledge, relevant for stakeholders such as farmers, land planners or policy makers.

In this study, we analyzed the influence of the landscape context, with different land uses and semi-natural landscape elements, on carabid communities and species richness in bordering cereal crops and grasslands from three different agricultural plains. We also focused on the gamma species richness, meaning sampled in the two paired fields from both land cover types. Our first hypothesis is that higher landscape heterogeneity, both compositional and configurational, enhances both crop and

grassland carabid species richness. We further investigated the effect of landscape composition and configuration on common species of the two land covers, as well as on their exclusive occurrence. Since the literature points out to the habitat and resource complementation between grasslands and crops for carabid communities, our second hypothesis is that we find more common species between paired fields when there is higher adjacency in the landscape between these two land cover types. In our case, higher adjacency would mean higher edge density through which the individuals can move from grasslands to croplands. As we studied three different agricultural plains, with three grassland coverage gradients, we finally analyzed the consistency of the landscape effect from one study region to another.

4.2 Material and Methods

4.2.1 Study regions and landscape characteristics

We studied the carabid assemblages and their landscape context in three agricultural plains of the Auvergne Rhône-Alpes region in southeastern France (Figure 18). They are all dominated by conventional intensive agriculture. The Bièvre and Rovaltain study regions are characterized by the dominance of crops such as maize, wheat, and oilseed rape. In Forez, livestock systems with use of permanent grasslands are more present than cropped areas. Our three study regions are representative of a gradient of grassland coverage: they represent 3 % of the whole area in Rovaltain, 16 % in Bièvre and 27 % in Forez (Massaloux et al. under review).

Like in other parts of France, crops are tilled (mostly between 20 and 25 cm deep) (Labreuche et al. 2011), chemically fertilized, as well as preventively protected through the application of pesticides, fungicides and herbicides (Butault et al. 2011). Winter cereals are typically sown in fall and harvested in June and July while spring crops are sown in April and May and harvested during late September and October. One precautionary application of herbicides is commonly applied to cereals, before or after winter. One preventive spraying of fungicides is applied during spring to avoid common fungal diseases with the increase of temperature and moisture. The use of pesticides can be more intense and is variable according to annual and local climate conditions. Permanent grasslands are mainly mown two to three times, and sometimes grazed.

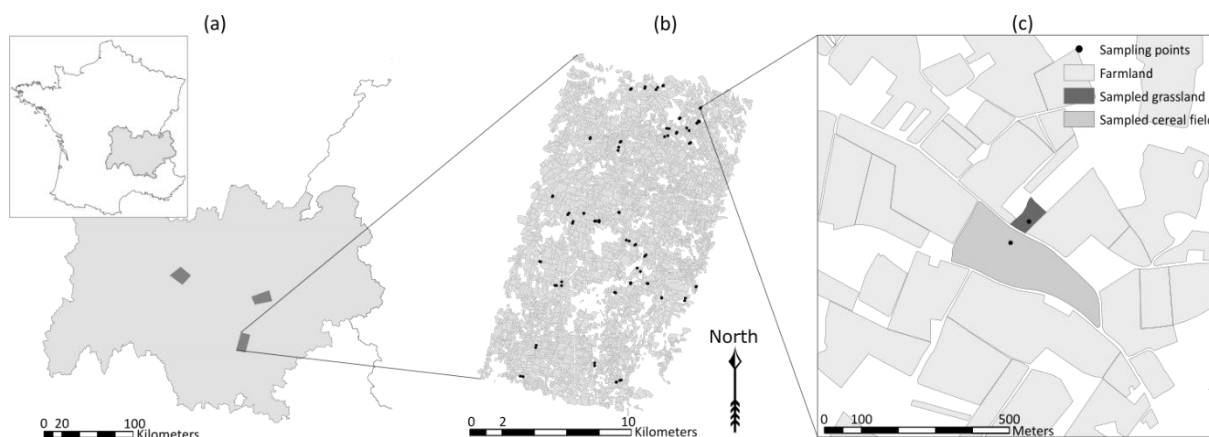

Figure 18. Spatial locations of (a) the three study regions in the Auvergne Rhône-Alpes region, France, (b) location of sampling points (either in cereal field or grassland) in the Rovaltain study region and (c) example of neighboring sampling location in paired cereal fields and grasslands.

4.2.2 Site selection and carabid sampling

For the sampling of carabids, we selected two contrasted agricultural land cover types in the different agricultural landscapes studied corresponding to different intensities of management and inputs: winter cereals and permanent grasslands. We tried though to use as few as possible grazed grasslands since cattle could damage the traps we set. Winter cereals were the most common crops overall in the three study regions. They respectively occupy 26 %, 18 % and 8 % of the whole study region in Rovaltain, Bièvre and Forez (Massaloux et al. under review). Sampled cereal fields were primarily cropped with wheat and barley and in fewer cases with triticale and rye. The fields were for the most tilled and synthetic inputs were used for fertilization and crop protection. Permanent grasslands were another important agricultural land cover in the studied landscapes, especially for livestock farming.

For analyzing carabid occurrences, we placed one pitfall trap per cereal field and grassland. Traps were set with at least 30 m to the land parcel border to limit edge effects. As we also wanted to study similarities of species assemblages in the two contrasted land covers, we selected pairs of sampling sites where cereal and grasslands fields were adjacent or in close vicinity, thus also having almost identical landscape context.

In 2017, 84 sites were sampled, with 43 cereal fields and 41 nearby grasslands. In 2018, there were 122 sites sampled with 61 cereal fields and 61 grasslands. We had two more samples in cereal fields than in grasslands due to the destruction of two traps by cattle. Carabids were sampled with pitfall traps (10 cm diameter) half-filled with a 50 % propylene glycol solution. A drop of detergent was added to reduce surface tension and thus prevent the escape of lighter carabid species. Polystyrene roofs (22 cm diameter) were set about 5 cm above each trap to prevent flooding of traps during rainfall events.

Each year, two field surveys were carried out with sampling periods of seven days. First period was between late April and early May, and second between late May and early June so that we could catch the most representative samples of spring breeding carabids. Each trap was thus open seven days twice per year. Species identification followed the keys of Jeannel (1941, 1942) and Coulon et al. (2011).

4.2.3 Data analysis

4.2.3.1 Carabid diversity indicators

For data analysis, we selected different carabid diversity indicators in order to describe the communities. We studied the per trap species richness we sampled in the permanent grasslands and in the cereal crops. We also analyzed the gamma species richness we found in the pairs of grassland and cereal crop field, as well as the species which were common to both land cover type in every pair, or exclusive to each of them. We grouped the sampling data of the first and the second sampling periods in order to summarize the whole diversity of carabids present each year in spring.

In order to have a first indication of the common species between the two land cover types, we calculated the Sørensen similarity index (Cardoso et al. 2009) with $\beta = \frac{2c}{S_1 + S_2}$ where c is the common species richness between the two paired sampled sites, and S_1 and S_2 the species richness of each site, in our case paired cereal field and grassland.

4.2.3.2 Landscape parameters

All the landscape parameters are the results of field recording within a radius of 500 meters around every sampled site. We processed our data through ArcGIS 10.4 (Esri 2015) in order to obtain different landscape indicators for three different landscape radii (200, 300, 500 m) around the sampling points (Figure 19). To analyze the compositional heterogeneity of the landscape we applied the Shannon diversity index. It is calculated as follows: $H' = -\sum_{i=1}^n p_i \ln p_i$ where p_i is the proportional area of the i^{th} land cover among the n land covers in the corresponding radius areas around the sampling points. The land cover types which were considered for the Shannon index are presented in Appendix A. The field border density, called in the following edge density, was measured by extracting the edges between land parcels and summing their total length in the three different radii areas. The winter crop-grassland edge density was obtained the same way, though it only considered the edges between adjacent parcels of winter crops and permanent grasslands. We tested the Spearman's rank correlation between the different landscape variables in every study region (Appendix G), in order to interpret more confidently our results.

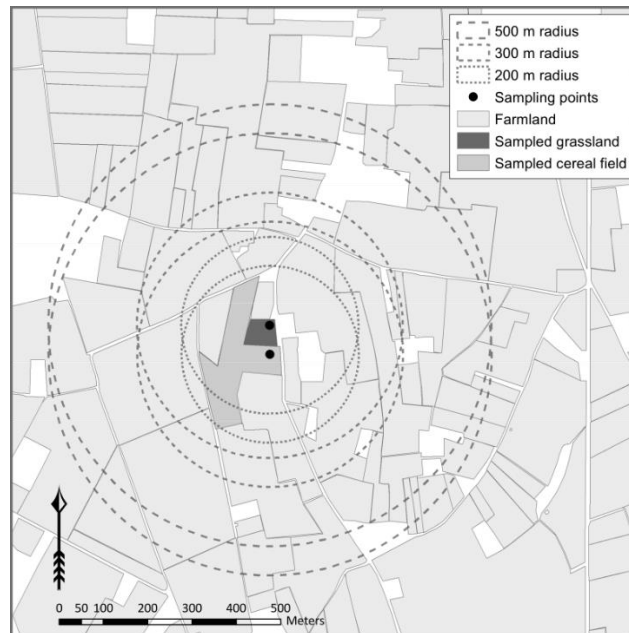

Figure 19. Different landscape context radii around the pairs of sampling points.

We performed a preliminary principal component analysis (PCA) with different landscape variables for the 200, 300 and 500 m radii areas around sampling points to determine the most explanatory variables as well as their correlation to other variables (Table 8). The PCA thus allowed the identification of a few variables which described best the landscape context (Table 9).

Table 8. Landscape parameters included in the preliminary PCA

Landscape parameter	Formula (always applied within the landscape radius)
Annual winter crop coverage ratio	Annual winter crop area / landscape radius area
Annual spring crop coverage ratio	Annual spring crop area / landscape radius area
Permanent grassland coverage ratio	Permanent grassland area / landscape radius area
Woodland coverage ratio	Woodland area / landscape radius area
Hedgerow coverage ratio	Hedgerow area / landscape radius area
Crop diversity	Number of different crops
Landscape Shannon diversity	$H' = -\sum_{i=1}^n p_i \ln p_i$ including all land cover types*
Crop Shannon diversity	$H' = -\sum_{i=1}^n p_i \ln p_i$ including only crop cover types*
Mean field size	Mean of the sizes of all fields
Mean field complexity	For all fields: mean of actual field perimeter / same-sized square field perimeter
Overall edge density	Edge density between all the fields
Winter crop / grassland edge density	Edge density between winter crops and permanent grasslands

* Presented in Appendix A.

4.2.3.3 Analysis of carabid diversity

Statistical analyses were conducted using R 3.6.0 (R Development Core Team 2019). We tested the impact of landscape variables (Table 9) with generalized model comparison (Guisan et al. 2002). We used the “MuMin” package for the multi-model inference analyses (Barton 2018), “ade4” for the multivariate analyses (Dray et al. 2018). For every landscape radius, we fitted a set of 15 different models altogether. Each of the 15 models was the combination of two landscape parameters, among the five we retained from the preliminary PCA (Table 9), with their interaction with the study region and the additive effect of the sampling year. Concerning the study region and the year of sampling, they could not be included in the models as random effects, since they had too few different levels. Thereby, we computed this two parameters as fixed effects (Bolker et al. 2009). Models with more than two explanatory variables were beforehand tested, but none was more parsimonious than those we retained for the final analysis.

Since we observed a higher significant correlation between the winter crop – permanent grassland edge density and the common species richness, compared to the correlation with overall edge density, it was used in the models sets. The null model included the additive effects of the study region and the sampling year.

Table 9. Selection of significant landscape parameters selected to analyze carabid species richness with generalized linear models comparison.

Parameter	Abbreviation in graphs	Type	Values / Metric
Grassland coverage ratio	grasslands	Continuous	Percentage of area
Hedgerows coverage ratio	hedgerows	Continuous	Percentage of area
Landscape Shannon diversity index ^a	Shannon	Continuous	Double
Edge density	ED	Continuous	m.ha ⁻¹
Winter crop – permanent grassland edge density	WC-PG ED	Continuous	m.ha ⁻¹

^aThe land cover types accounting for landscape Shannon index are presented in Appendix A.

All the species richness models were fitted with Poisson distribution errors. Common species richness models were fitted with binomial distribution errors (1 = common species, 0 = exclusive species). We used the Akaike Information Criterion corrected for small sample size (AIC_c) to select models offering the best compromise between fit and simplicity (i.e., the most parsimonious model) (Symonds and Moussalli 2011). For each explained variable we selected the most parsimonious models, *i.e.* whose ΔAIC_c was inferior to 2 (Burnham and Anderson 2002; Burnham and Anderson 2004). When there was more than one model, we averaged them in order to retain as much information as possible on the

significant explanatory variables (Burnham and Anderson 2002; Johnson and Omland 2004). We always checked the null model ΔAIC_c to verify the significance of our model selection (a ΔAIC_c lower than 2 involved no significant effect of explanatory variable).

4.3 Results

4.3.1 Major landscape and species differences between the three study regions

All the results were tested for the 500, 300 and 200 m radii landscapes around the sampling points in our generalized linear models sets. However, the 200 m radius always appeared to be the most parsimonious one to explain all the studied species richness. Thus we will focus on this radius.

The landscape context and the land cover percentages in the 200 m radius areas around the sampling points in winter crops and grasslands showed important differences between the three study regions (Table 10). Average coverage with annual winter crops, cereals and rapeseed, was higher in Rovaltain and Bièvre, with respectively 35 % and 32 % of the areas, though this was much lower in Forez with only about 19 %. Annual spring crops, maize, sunflower and soybean, were similar in all three study regions, with 15 % in Rovaltain and Bièvre and 12 % in Forez. Other crops were scarce with no more than 2 %. We noticed two levels of grassland coverage in the studied 200 m areas. It was the highest in Forez, with an average of 36 %, Bièvre was close with 32 %, and Rovaltain was the lowest with only 20 %. Two land cover types had low average values in the three study regions in the 200 m areas: hedgerows with 3 %, and woodland with about 8 % in Rovaltain, and 5 and 6 % respectively in Bièvre and Forez. The landscape diversity was equivalent in Rovaltain and Bièvre, where the crops had a higher coverage and their diversity was higher, though it was substantially lower in Forez where the grasslands were more important in the landscape. Rovaltain had the lowest mean edge density with 48 $m \cdot ha^{-1}$, Forez was intermediate with 75 $m \cdot ha^{-1}$ and Bièvre was the highest with an average of 94 $m \cdot ha^{-1}$. We observed a lower winter crop-grassland edge density in Rovaltain (11 $m \cdot ha^{-1}$) than in Forez (17 $m \cdot ha^{-1}$) and Bièvre (20 $m \cdot ha^{-1}$).

Table 10. Landscape characteristics in the 200 m radius area around sampling points in the three study regions.

	Annual winter crop (%)		Annual spring crop (%)		Other crops ^a (%)		Permanent grassland (%)		Hedgerows (%)		Woodland (%)		Landscape Shannon index		Edge density (m.ha ⁻¹)		WC-PG edge density (m.ha ⁻¹)	
	Mean	± SD	Mean	± SD	Mean	± SD	Mean	± SD	Mean	± SD	Mean	± SD	Mean	± SD	Mean	± SD	Mean	± SD
Three study regions	29	± 16	14	± 13	2	± 4	29	± 17	4	± 5	6	± 8	1.29	± .23	70	± 39	16	± 14
Rovaltain	35	± 14	15	± 14	2	± 4	20	± 14	3	± 4	8	± 9	1.30	± .22	48	± 20	11	± 12
Bièvre	32	± 18	15	± 12	2	± 5	32	± 18	4	± 4	5	± 6	1.32	± .24	94	± 42	20	± 17
Forez	19	± 9	12	± 12	1	± 2	36	± 16	4	± 6	6	± 8	1.23	± .23	75	± 39	17	± 11
Anova ^b (R ² p-value)	.18	<.001	.01	0.49	.04	.15	.18	<.001	.01	0.53	.01	.49	.02	.32	.28	<.001	.07	.023

^a Orchards, vineyards and protein crops other than soybean, oilseed crops, market gardening and horticulture

^b One-way Anova between landscape parameter and study region

Note: WC = winter crop, PG = permanent grassland.

Table 11. Carabid species richness in the three different study regions.

	Gamma species richness		Winter cereal species richness		Permanent grassland species richness		Common number of species		Sørensen similarity index		Sampled traps	Sampled traps in winter cereal crops	Sampled traps in permanent grasslands
	Mean	± SD	Mean	± SD	Mean	± SD	Mean	± SD	Mean	± SD			
Three study regions	12.0	± 5.3	7.1	± 3.4	6.5	± 4.4	1.6	± 1.8	0.20	± .18	206	104	102
Rovaltain	8.8	± 4.4	4.9	± 2.7	4.7	± 3.7	0.8	± 1.0	0.14	± .16	82	41	41
Bièvre	13.2	± 4.2	8.4	± 3.1	7.0	± 3.9	2.1	± 1.9	0.25	± .20	65	33	32
Forez	15.1	± 5.3	8.7	± 3.2	8.7	± 4.9	2.3	± 2.2	0.23	± .17	59	30	29

In Rovaltain only, the winter crop-grassland edge density was correlated to the grassland coverage (the significant correlations between landscape variables within the 200 m radius are presented in Appendix G). In Bièvre, we found more diversity in the landscape when there was higher edge density. In Forez, we found lower grassland areas when the 200 m radius areas were more diverse. In Rovaltain and Bièvre, the edge density was significantly correlated with the winter crop-grassland edge density.

Mean gamma species richness of paired sites, from both land cover types, was lower in Rovaltain, with about 9 species, than in the two other study regions with 13 and 15 (Table 11). In cereal crops, we sampled fewer species per trap in Rovaltain than in Bièvre and Forez, where the richness was similar. We observed three different levels of carabid species richness in permanent grasslands: it was the

lowest in Rovaltain, higher in Bièvre and the highest in Forez, though it was also more dispersed in the latter. Generally, the number of species in cereal crops was slightly higher than in grasslands. The number of species which were common to both grassland and winter cereal in the study regions was higher in Rovaltain, with 41 species, than in the two other study regions with 33 and 30, respectively. Sørensen similarity was the lowest in Rovaltain though it had similar levels in Bièvre and Forez.

4.3.2 Gamma species richness, from both land cover types

The multivariate analysis showed that the gamma carabid species richness was best explained by landscape Shannon diversity and edge density in the 200 m radius, both interacting with the study region (Appendix H.1). Gamma species richness was higher for the Bièvre study region when the landscape in the 200 m radius was more diverse, though it was lower in Forez and was not impacted by this variable in Rovaltain (Figure 20a). The edge density showed a positive relationship with the gamma carabid species richness in Rovaltain and Forez, whereas it was not the case for Bièvre (Figure 20b).

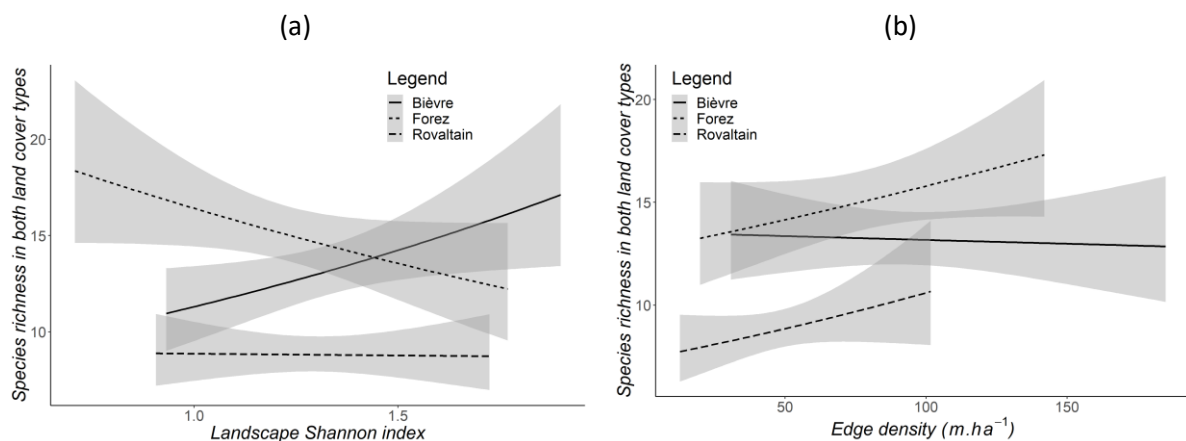

Figure 20. Significant variables and interactions effects of multivariate model analyses of the gamma species richness in the three study regions and land use in the 200 m radius, explained by: (a) landscape Shannon diversity index, (b) overall edge density.

Note: The area around the curve is the 0.95 margin error.

4.3.3 Permanent grassland and winter cereal crop species richness

The multivariate analyses showed that only the landscape Shannon diversity index had a significant correlation with carabid species richness in grasslands, though the effect was different from one study region to another (Appendix H.2). In Bièvre, we observed a higher species richness in grasslands with increasing landscape diversity within a 200 m radius around the sampling points (Figure 21). On the

contrary, grassland carabid species richness was lower when the landscape was more diverse in Forez. No clear effect was found for Rovaltain.

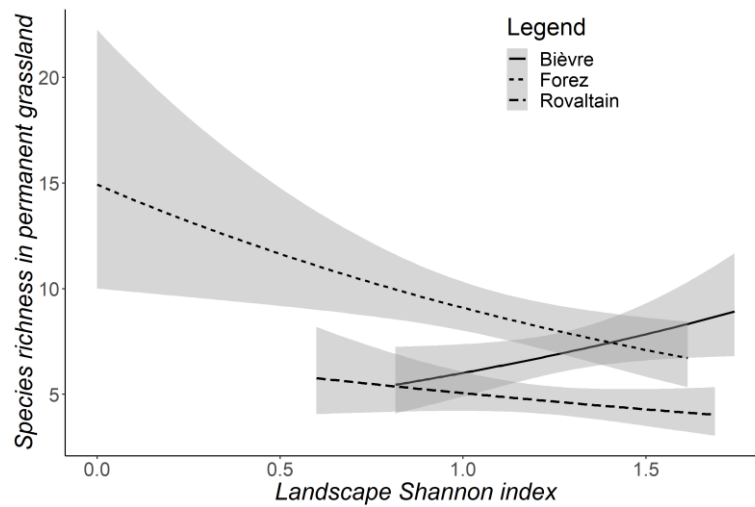

Figure 21. Significant interaction effect of the permanent grassland species richness and the landscape Shannon diversity index in the three study regions for the 200 m radius land use.

Note: The area around the curve is the 0.95 margin error.

In winter cereal crops, no landscape variables significantly explained species richness. Only the study region did with the carabid species richness of cereal crops being lower in Rovaltain than in Bièvre and Forez (Appendix H.3 and Table 11).

4.3.4 Common species richness

The ratio of common species between the land cover types is also best explained with the 200 m radius. Both landscape Shannon diversity and winter crop-grassland edge density were interacting with the study region (Appendix H.4). We found an overall higher ratio of common species when there was a higher edge density (Figure 22a), but not specific significant differences for the different study regions. The proportion of common species was also higher with increasing percentage of grassland in the 200 m radius for two study regions. The increase of grassland coverage positively influenced the ratio of common species between the sampled pair of grassland and cereal crop, but only in Rovaltain (Figure 22b).

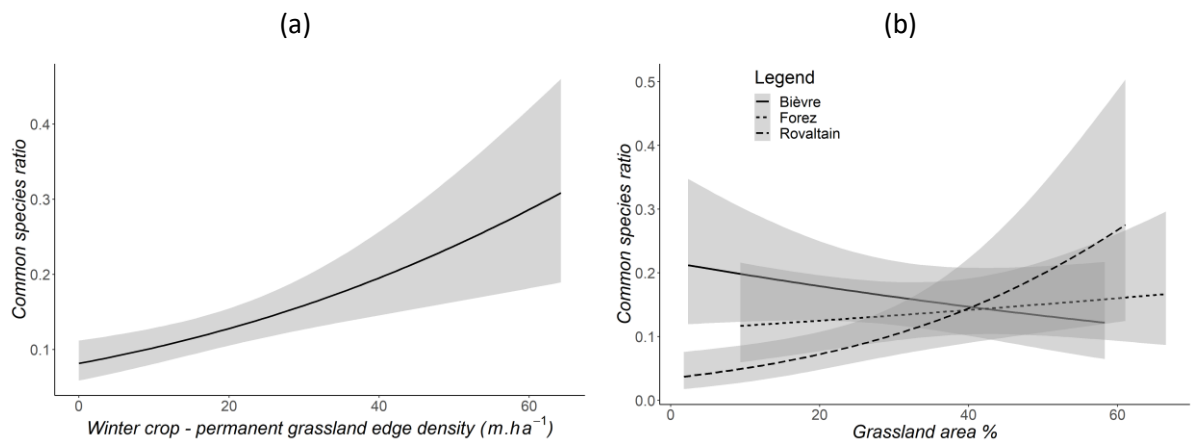

Figure 22. Significant variables and interactions effects of multivariate model analysis of the common species richness ratio in the three study regions in the 200 m radius explained by: (a) winter crop – permanent grassland edge density, (b) grassland area percentage.

Note: The area around the curve is the 0.95 margin error.

4.4 Discussion

We analyzed different carabid species richness indices from two neighboring land cover types and their relation to different landscape indicators (Table 12). Landscape diversity and edge density explained gamma species richness; though different effects were observed from one study region to another. As expected, we found a higher species richness in grasslands surrounded by more diverse landscapes (Bièvre study region), whereas in Forez grassland species richness was higher with lower landscape diversity. In winter cereal crops, the tested landscape parameters showed no significant effect on species richness. Finally, the common species were more numerous among the assemblages of both land cover types when there was a higher winter cereal – permanent grassland edge density, or where there were more grasslands in the surroundings in Rovaltain.

Table 12. Summary of significant effect of landscape variables on carabid species richness and in relation to study regions.

Species richness	Landscape variable	Study region(s)	Effect signature
Gamma	Landscape Shannon diversity	Bièvre	+
		Forez	-
	Edge density	Forez and Rovaltain	+
Grassland	Landscape Shannon diversity	Bièvre	+
		Forez	-
Common ratio	WC-PG edge density	All	+
	Grassland ratio	Rovaltain	+

4.4.1 Landscape diversity and edge density explain carabid species richness

We hypothesized that both configurational and compositional landscape would enhance the carabid richness found in cereal fields, grasslands and in both land cover types. This hypothesis was not verified in every study region. We mostly found that both landscape Shannon diversity and edge density had positive significant correlations with gamma carabid species richness. This is relevant to previous works which show that landscape diversity is known to enhance carabid richness of both cereal crops and semi-natural grasslands (Weibull et al. 2003; Hendrickx et al. 2007; Billeter et al. 2008).

We observed though that the effect of landscape diversity on gamma and grassland species richness is negative in one study region (Forez), the one where the grasslands coverage is the highest. In fact, we found more grasslands where the landscape compositional diversity is lower in this study region since these two variables were highly negatively correlated (Appendix G). Batáry et al. (2007) observed as well this negative correlation between landscape diversity and grassland coverage. They furthermore saw that grassland carabid communities become less diverse when the surrounding grassland coverage is decreasing, hence when the landscape is more heterogeneous with other types of land use. They argue that this lower carabid diversity is explained by lower specialist species richness when the grassland coverage is lower (higher landscape diversity). On the contrary, habitat generalists benefit from higher landscape diversity (Jonsen and Fahrig 1997; Batáry et al. 2007). Hence, the gamma and grassland species richness are higher when there is more grassland coverage in the surroundings because specialist species are favored by this important grassland mosaic.

Higher edge density increased the gamma species richness in two study regions, which converges with a recent study (Gallé et al. 2018b). Indeed, field edges generally host semi-natural elements with herbaceous covers which can host species that would not dwell within the field (Thomas et al. 2001; Marshall et al. 2001). Parcel edges can as well shelter carabids (Thorbek and Bilde 2004; Schirmel et al. 2016), preventing them from dying in case of perturbation of the cropped habitat, like tillage for example. Moreover, Jowett et al. (2019) showed that in-field carabid species richness decreased when the sampling went further from the parcel boundary into the field, which argues in favor of the role of edges for enhancing carabid diversity.

However, there was no significant effect of edge density on gamma diversity in Bièvre as well as for landscape Shannon diversity on permanent grassland and gamma species richness, whereas there was no influence of landscape parameters on cereal field carabid richness. This thereby implies that the effect on the gamma richness is mainly due to the grassland carabid community. Hence, it is possible that we did not find the same positive influence of edge densities on the gamma diversity as compared to the two other study regions.

4.4.2 Landscape parameters impact on carabid richness in grasslands but not in cereal crops

In our study we found that landscape parameters impact on carabid richness in grasslands but not in cereal crops. This is in contrast with other studies which could show that there is a relation between cropland carabid richness and landscape heterogeneity (Fahrig et al. 2011; Fahrig et al. 2015; Madeira et al. 2016) or the proximity of semi-natural elements (Purtauf et al. 2005; Burel and Baudry 2005; Dufлот et al. 2017; Holland et al. 2017). However, some other research also pointed out that species richness of cropland carabid communities was not influenced by landscape heterogeneity (Winqvist et al. 2011). In agricultural landscapes, carabid diversity is strongly determined by the land cover in which it is sampled (Dauber et al. 2005; Ng et al. 2018).

One explanation may be that in our study carabid species richness in cereal crops may have been strongly impacted by farmers' management. Almost all the cropped fields we sampled were conventionally farmed. We guess that conventional practices may have stronger impacts on carabid communities than landscape context. Indeed, more intensive practices are known to lower the species richness of phytophagous and polyphagous species (Winqvist et al. 2011). The impact of farming practices has been pointed out in multiple ways. First, insecticides are usually decreasing carabid diversity (and abundance), both directly by killing the individuals themselves or indirectly by reducing dramatically their prey number. Second, as carabids are ground-dwellers and many during winter

underground, tillage has an impact on their diversity by physical destruction or consistent disturbance of their habitat. Indeed, no-till or reduced tillage with no soil inversion are less destructive for carabid communities (Holland and Luff 2000; Holland and Reynolds 2003; Hatten et al. 2007). Third, herbicides are indirect threats, either by reducing the ground vegetation cover and with this food resources for certain species (Kromp 1989; Pfiffner and Luka 2003; Geiger et al. 2010). Finally, higher fertilization increases the canopy density, then altering the ground surface micro-climate, and therefore reducing the occurrence of xero-thermophilous carabid species. The type and amount of fertilization can also have an impact with for example organic fertilizers increasing epigeal arthropods diversity (Pfiffner and Luka 2003).

Otherwise, a second explanation can be that the cereal fields we sampled were not or rarely sprayed with insecticides, hence giving a rather stable habitat to their carabid communities. Indeed there is some evidence that carabids can be *relatively* tolerant to non- or low- insecticidal conventional farming managements (Navntoft et al. 2006; O'Rourke et al. 2008). Moreover, cropland carabids are usually dominated by opportunistic xero-thermophilous species, which are used to open habitats and tolerate some disturbance (Burel and Baudry 1995; Fournier and Loreau 1999; O'Rourke et al. 2008). Semi-natural habitat communities are on the contrary composed with a wider variety of species, of which a substantial number is attached to habitat stability of perennial and dense vegetation (Thiele 1977; Luff 1996). Semi-natural habitat species are thereby slower colonizers than cropland ones (Burel and Baudry 1995). Then, after an insecticide spray, the cropland species can definitely outcompete the ones from semi-natural habitats in the recolonization of a field (Holland and Luff 2000; Lee et al. 2001b). Thereby, the carabid communities we sampled in cereal fields may have been so adapted to this habitat and its disturbance that they are not or little influenced by the neighboring landscape and hereby preventing other species which could potentially disperse from adjacent habitats.

4.4.3 Adjacency between winter crops and grasslands drives common species richness

We expected higher adjacency between grassland and cropland to enhance the number of common species between the communities of these two land cover types. Indeed, our study suggests that a higher grassland-cropland edge density enhances the common species ratio between cropland and grassland communities. Furthermore, we found more common species in sampling sites of Rovaltain where the surroundings had higher grassland coverage. Indeed, edges between grasslands and crops enhances multi-habitat carabid gamma diversity (Batáry et al. 2012; Duflot et al. 2017). This can be due to food resource complementation (Dunning et al. 1992; Fahrig et al. 2011; Duflot et al. 2017) or habitat complementation for overwintering (Holland et al. 2005; Gallé et al. 2018a). Moreover, it

supports carabids spillover in two ways: after harvest, when preys are lacking, they move from croplands into neighboring grasslands (Schneider et al. 2016). They move back into the croplands after winter when the conditions suit them again. Our findings support that habitats between cropland and grassland seem not be a barrier for some carabid species and might allow migration between cropland and grassland.

4.4.4 Landscape radii level explains species richness

Among the three radii tested, the 200 m radius landscape was the best to explain the gamma carabid richness, the species richness in grasslands as well as the common species ratio. This is related to previous works (Weibull et al. 2003; Schweiger et al. 2005) which also show the importance of close field edges and landscape diversity for carabid species richness. Thomas et al. (2001) showed that closer located landscape elements, such as hedgerows or the occupation of adjacent fields, are important features to host species diversity. They observed that some carabid species only dwell along the field boundaries, for example in vicinity of a hedgerow or grassland, or in certain areas where herbaceous plant cover is higher. Finally, the close landscape, i.e. the field and its adjacency, can act as a filter for species composition and diversity (Thomas and Marshall 1999). In particular, some predatory species need to migrate to neighboring fields to find prey during certain periods in the year or their life-cycle, hence their diversity directly relies on the diversity of the closer landscape (Fusser et al. 2017).

4.4.5 Consistency of the landscape effect between study regions

Our last objective was to evaluate the consistency of the landscape effect on the different species richness parameters studied. We observed diverse responses of gamma and grassland carabid species richness to landscape diversity and edge density among study regions. Gamma species richness was differently explained by landscape diversity and edge density according to the study region, whereas the effect of landscape diversity on grassland richness was different in Forez compared to the two other study regions (Table 4). Common species were not influenced the same way by grassland coverage in different study regions. We observed that the relationship between carabid species richness with landscape surroundings can be inconsistent from one region to another because of differences in local farm managements or environmental conditions (Karp et al. 2018). Further, regional scales are an essential factor to explain species composition (Schweiger et al. 2005). Many regional abiotic factors, such as soil type, pH or clay, water and organic contents are explanatory of carabid diversity (Holland and Luff 2000). And these characteristics are directly linked to the regional pedoclimatic conditions. Moreover, Tschardt et al. (2005) observed that in agricultural regions

where biodiversity is already high, the beneficial effect due to low management intensity is less important. They argue that more complex landscapes generally host higher biodiversity, then the impact of beneficial anthropogenic management is lower than in simple landscapes dominated by arable fields. In a meta-analysis, Tuck et al. (2014) indeed observed that the beneficial effect of organic farming for biodiversity was more important in intensive landscapes.

All these explanations can enlighten the sometimes diverging landscape effects between study areas. Indeed, Bièvre, Rovaltain and Forez have different pedoclimatic conditions. The annual rainfalls are of 650 mm in Forez, 880 mm in Bièvre and 960 mm in Rovaltain. Soils in Forez are mostly sandy-loamy, with some clayey areas, Rovaltain is mostly covered with silty soils and Bièvre with moraine soils. Forez and Bièvre have temperate semi-continental climate, whereas Rovaltain is more influenced by both semi-continental and Mediterranean climates. The farming intensity in the three study regions can only be differentiated through their coverage gradient between permanent grasslands, which are extensively managed, and crops, which are intensively managed.

4.4.6 The role of permanent grasslands and landscape diversity for the management of carabid species

Our observations in Bièvre converges with previous findings which emphasized the importance of crop diversity for enhancing carabid species richness (Schweiger et al. 2005). Indeed, cropland carabids move along diverse crops for foraging (Marrec et al. 2017). Thus, they need a complex compositional mosaic in order to find resource and habitat complementarity. In the absence of crop diversity, carabids can as well disperse into neighboring grasslands (Schneider et al. 2016) where they also find overwintering shelters (Kromp 1999; Holland et al. 2005; Gallé et al. 2018a). That is probably what we observed in Forez. Accordingly, non-cropped semi-natural areas are recurrently pointed out as important drivers for carabid diversity in agricultural landscapes (Tscharntke et al. 2005a). Knapp and Řezáč (2015) observed that even small sized semi-natural habitats efficiently enhance carabid richness of arable fields. For example, grass and flower strips give more resilience to carabid communities from adjacent cropped fields where insecticide was sprayed and hence can potential improve biocontrol (Lee et al. 2001b; Menalled et al. 2001; Marshall et al. 2001).

Based on the different findings of our study and literature, several recommendations could be made to policy makers and farmers to support occurrence of carabids and enhance their functional role as biocontrol agents. Our research emphasizes the potential of permanent grasslands to enhance carabid diversity in the adjacency of croplands, even in intensively cropped landscapes, combined with adapted farming practices in order to enhance potential of conservation biological control by carabid

beetles. More generally, farmland mosaic needs a variety of crops as well as semi-natural elements. Then, grasslands, even if small, can provide refuge habitats to beneficial fauna. In a much wider study on multiple regions and multitrophic species, Sirami et al. (2019) pointed out the consistent importance of semi-natural coverage, small field size and crop diversity to enhance general diversity. There is indeed a need for policies which favor this arrangement of agricultural landscapes. Bringing back permanent grasslands into regions dominated by crops would also benefit cropping systems through biological control conservation (Chaplin-Kramer et al. 2011; Landis 2017). Moreover, extensive grazing indeed is a beneficial management to maintain both farming activities and carabid diversity (Gustavsson et al. 2007; Dostálek and Frantík 2008; Römermann et al. 2009). Reshaping the agricultural landscapes is another way to enhance conservation biological control, the enhancement of natural enemies abundance and diversity by the provision of the resources they need (Barbosa 1998; Fiedler et al. 2008), by down-sizing the fields, which has the consequence to increase the edge-density. Small-scale farming indeed is known to enhance carabid and spider diversity (Fahrig et al. 2015; Sirami et al. 2019).

4.5 Conclusion

Our research suggests that there is a complementarity between grassland and cereal carabid communities. The vicinity of semi-natural habitats, like permanent grasslands, which also provide complementation of resources or habitat, must be an asset for some species which can move, especially in case of agricultural disturbance of the field. Our research points out the need for preservation or restoration of a grassland mosaic along with more diverse cropped landscapes to enhance carabid beetles and consequently increase the potential of conservation biological control which is important for future agricultural production with less or no pesticides.

5. Functional traits of carabid assemblages in adjacent grasslands and cereal fields

Damien Massaloux^a, Benoit Sarrazin^a, Anthony Roume^a, Vincent Tolon^a, Alexander Wezel^a

^a Isara, Agroecology and Environment research group, 23 rue Jean Baldassini, 69364 Lyon, France

This chapter is an original article still under preparation.

5.1. Introduction

Since the 1950's, agricultural intensification led to a dramatic loss of biodiversity in Europe (Stoate et al. 2009; IPBES 2018a). Intensive agriculture drove to the development of mono-cropping (Power and Follett 1987; Mudgal et al. 2010) as well as the intensive use of insecticides, herbicides, fungicides or fertilizers (Robinson and Sutherland 2002; Mazoyer and Roudart 2006; Bianchi et al. 2006). Intensification has also been responsible for the simplification of farmed landscapes, with the dominance of a few crops along with enlarged fields (Benton et al. 2003; Flohre et al. 2011; Tscharrntke et al. 2012a; Gámez-Virués et al. 2015). Further, many grasslands were progressively turned to cropland or abandoned (Peeters 2012). By negatively impacting biodiversity, intensive agriculture also threatens ecosystem services, even the ones from which it benefits (Costanza et al. 1997; Emmerson et al. 2016) such as biological control, pollination and nutrient recycling. Agroecology suggests to replace synthetic inputs, typical of intensive agriculture, by ecosystem services (Wezel et al. 2014; Altieri et al. 2018). This would serve two goals: reduce the negative impact of farming activities on biodiversity, as well as improve the efficiency or enhancement of different ecosystem services, among them biological control (Altieri et al. 2018).

Carabids are important biological control providers in cereal fields (Kromp 1989; Kromp 1999; Moonen and Bàrberi 2008). Most species are aphidophagous, though larger ones can also prey on slugs and snails (DeBach and Rosen 1991; Dainese et al. 2017b; Altieri et al. 2018). Other species are phytophagous and forage also on weed seeds (Menalled et al. 2007; Bretagnolle et al. 2012; Trichard et al. 2013). Since carabids are natural enemies of pests and weed seeds reducers, they can be of great benefit for farming activities.

Carabid species composition is majorly determined by type and quality of habitats (Thiele 1977; Kromp 1999; Tuck et al. 2014). A broad variety of carabids can be found in agricultural landscapes, where they live in cropland, grassland, woodland or even semi-natural elements such as hedgerows. Although woodland carabids are rather confined to their original habitat (Dufлот et al. 2014), species in crops

and grasslands can eventually need to move between these habitats. As croplands are disturbed habitats due to farming activities, their carabid communities may spillover into neighboring habitats, such as grasslands or other crops (Schneider et al. 2016). Furthermore, carabids can also migrate into grasslands to overwinter (Holland et al. 2005; Gallé et al. 2018a).

Carabids from cropland and grassland show some differences in their traits. Indeed, species occurring in cereal crops are often more mobile than in grasslands as they need to be able to migrate in case of disturbance of their habitat by agricultural activities (Ribera et al. 2001; Pakeman and Stockan 2014). Three carabid traits are well studied and inform about the biological control potential as well as the mobility of the individuals: the adult diet, the size and the wing status (Kromp 1989; Kromp 1999; Holland 2002).

Carabid species also tend to be smaller in croplands than in grasslands, since they are more exposed to impacts of soil tillage which can be lethal to larger individuals (Kromp 1999). Furthermore, since cropland carabids live in a disturbed habitat which provides both vegetative and invertebrate food resources, they are for the most generalist species. Grassland carabids species indeed are more phytophagous species or even generalist species.

The landscape is also known to act as an important trait filter for carabids. Ecological filtering is the process through which species are determined by habitat, environmental factors and ecological interactions (Magura et al. 2015), as opposed to random processes (Pausas and Verdú 2010). Agricultural intensification leads to the homogenization of species traits (Dufлот et al. 2014; Gámez-Virué et al. 2015) through two synergistic processes: the reduction of landscape heterogeneity and the disturbance with farming practices. Lower landscape compositional heterogeneity selects against specialized traits, and then favors generalist or opportunistic species. Small species are more often found within a dominance of croplands, while in grassland areas the diversity of large and specialized carabids is enhanced. Moreover, many species found in grasslands depend on the landscape context. In landscapes dominated by grasslands, carabid species are mostly grassland specialists, whereas they are more generalists when the landscape is covered by cropland (Batáry et al. 2007).

Although the influence of the habitat and landscape context on carabid life traits are well-known in agricultural landscapes, the assemblages in adjacent grasslands and cereal crops have been little studied so far. Most studies have either focused on one of the two habitats (Purtauf et al. 2005; Hendrickx et al. 2009; Wamser et al. 2012), or on multiple habitats analyzed altogether (Dufлот et al. 2014). Yet, cereal crops and grasslands are two major components of agricultural landscapes, and their vicinity can provide refuge habitats and food resources for carabids (Dunning et al. 1992; Pfiffner and Luka 2000; Fahrig et al. 2011).

In this study, we aimed at disentangling the effects of land cover type and landscape on the carabid life traits of two different farmland covers. Our first objective was to evaluate the probability that paired grassland and cereal crop share carabid species according to three of their functional traits: size, diet and wing status. We hence hypothesized that more generalist and mobile species, meaning polyphagous and/or macropterous carabids, would be more likely to be sampled in both paired cereal crop and grassland (*hypothesis i*).

Our second objective was to find out whether functional traits are influenced by the field of landscape parameters. Then, we hypothesize that phytophagous and carnivorous, meaning polyphagous and predatory, species would be more likely to be caught respectively in grasslands and cereal crops (*hypothesis ii*). We also suggest that more mobile species, meaning larger and/or macropterous would be more caught in cereal crops than in grasslands (*hypothesis iii*).

Finally, our third objective was to analyze whether the landscape context influence is the same way carabid communities in permanent grasslands and cereal crops. Therefore, we expected higher landscape heterogeneity to lower the specialization, meaning phytophagy and absence of wings, of carabids found in grasslands, while this parameter would have no effect on cereal crops carabids (*hypothesis iv*).

We present the results of these analyses and discuss their implication to enhance functionality of landscapes for carabids in farmland. This includes to look at the landscape complementation theory, applied to carabid traits, in the perspective to formulate potential recommendations for farmers, landscape planners and policy makers about the agroecological value of grasslands in agricultural landscapes for conservation biological control.

5.2. Material and Methods

5.2.1. Study regions and landscape characteristics

We studied the carabid assemblages and their landscape context in three agricultural plains of the Auvergne Rhône-Alpes region in southeastern France (Figure 23). They are all mostly dominated by conventional intensive agriculture. The Bièvre and Rovaltain study regions are characterized by the dominance of crops such as maize, wheat, and oilseed rape, whereas in Forez livestock systems with use of permanent grasslands are more present than cropped areas. Bièvre and Forez have temperate semi-continental climate, whereas Rovaltain is influenced by both semi-continental and Mediterranean climates.

Like in other parts of France, crops are tilled (mostly between 20 and 25 cm deep) (Labreuche et al. 2011), chemically fertilized, as well as preventively protected through the application of pesticides, fungicides and herbicides (Butault et al. 2011). Winter cereals are typically sown in fall and harvested in June and July while spring crops are sown in April and May and harvested during late September and October. One precautionary application of herbicides is commonly applied to cereals, before or after winter. One preventive spraying of fungicides is applied during spring to avoid spread of fungal diseases with the increase of temperature and air moisture. The use of pesticides can be more intense and is variable according to annual and local climate conditions. Permanent grasslands are mainly mown two to three times, and sometimes grazed.

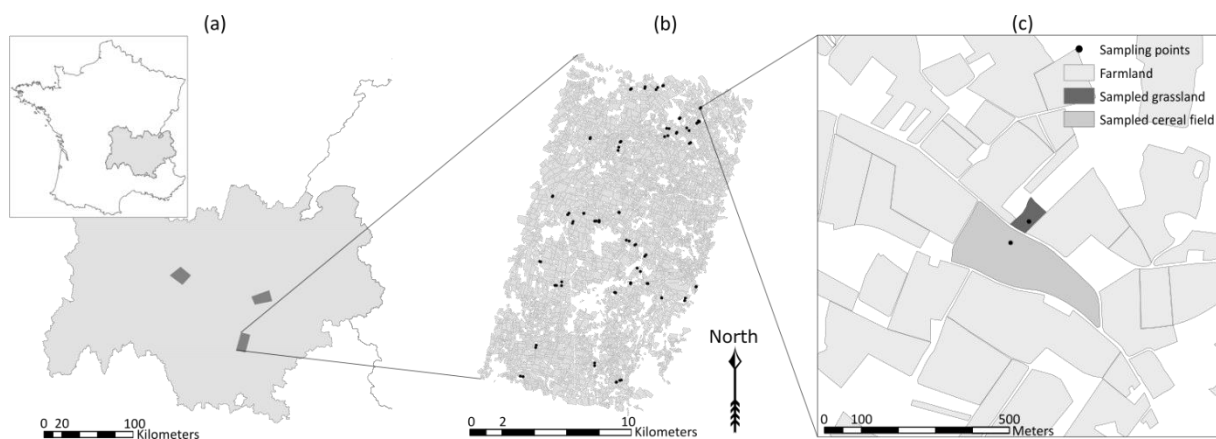

Figure 23. Spatial locations of (a) the three study regions in the Auvergne Rhône-Alpes region, France, (b) location of sampling points (either in cereal field or grassland) in the Rovaltain study region and (c) example of neighboring sampling location in paired cereal fields and grasslands.

5.2.2. Site selection and carabid sampling

We selected two contrasted agricultural land covers corresponding to different intensities of management and inputs: winter cereals and permanent grasslands. Winter cereals have the higher share among croplands when considering the three study regions: they respectively occupy 26%, 18% and 8% of the whole study area in Rovaltain, Bièvre and Forez. Furthermore, our three study areas are representative of a gradient of grassland coverage: they represent 3% of the whole area in Rovaltain, 16% in Bièvre and 27% in Forez.

Sampled cereal fields were primarily cropped with wheat and barley and in fewer cases with triticale and rye. They were for the most part tilled and farmed with chemical inputs. Permanent grasslands were another important agricultural land cover in the studied landscapes, especially for livestock farming. For analyzing carabid occurrences, we placed pitfall traps in cereal fields and grasslands, with agreement of farmers. Traps were placed with at least 30 m to the land parcel border to limit edge

effects. As we wanted to study similarities of species assemblages in the two contrasted land covers, we selected couples of sampling sites where cereal and grasslands fields were adjacent or in close vicinity, thus also having identical landscape context.

In 2017, 84 sites were sampled, with 43 cereal fields and 41 nearby grasslands. In 2018, there were 122 sites sampled with 61 cereal fields and 61 grasslands. We had two more samples in cereal fields than in grasslands due to the destruction of two traps by cattle. Carabids were sampled with pitfall traps (10 cm diameter) half-filled with a 50% propylene glycol solution. A drop of detergent was added to reduce surface tension and thus prevent the escape of lighter carabid species. Polystyrene roofs (22 cm diameter) were set about 5 cm above each trap to prevent flooding of traps during rainfall events. Each year, two field surveys were carried out with sampling periods of seven days. First period was between late April and early May, and second between late May and early June so that we could catch the most representative samples of spring breeding carabids. Each trap was thus open seven days twice per year. Species identification followed the keys of Jeannel (1941, 1942) and Coulon et al. (2011). In addition, species were classified into life traits (diet, wing status, size) with the use of available literature (Jeannel 1941; Jeannel 1942; Lindroth 1992; Ribera et al. 2001). We chose to group the sampling data of the first and the second sampling period in order to summarize the whole diversity of carabids present each year in spring.

5.2.3. Data analysis

5.2.3.1. Carabid life traits

We identified three different carabid life traits which were associated with two vital functions: diet and mobility (Table 13). All the 115 sampled species were associated with a value of the three life traits (Appendix D). The adult diet was categorized into three values: phytophagous, for seed-feeders, predatory entomophagous species and polyphagous for species which can feed on both resource types (Table 13). Wing status relates to the development of wings on adults: apterous do not have wings, macropterous species that have fully developed wings, and dimorphic present both phenotypes on adults (Kromp 1999). The size has been divided into four categories very small, small, medium and large. Both size and wing status inform about the species mobility.

Table 13. Carabid life traits categories used in the generalized linear mixed models (GLMm) and RLQ analyses.

Carabid life trait		GLMm	RLQ
Adult diet	Phytophagous		
	Polyphagous		
	Predatory		
Wing status	Apterous	0	
	Dimorphic	1	
	Macropterous	2	
Size	Continuous (mm)	Logarithmic	Very small (< 6 mm)
			Small (>6 – 8 mm)
			Medium (>8 – 10 mm)
			Large (> 10 mm)

5.2.3.2. Effects of life traits on carabid exclusiveness or commonness in the paired contrasted land cover types

Statistical analyses were conducted using R 3.6.0 (R Development Core Team 2019). One sample of a given species was considered shared when it was sampled in both paired cereal field and grassland. On the contrary, a sampled species was considered as exclusive when it was only sampled in one of the two paired land covers, and then considered as exclusive to the land cover it was found in.

We performed two sets of generalized mixed models (GLM) (Guisan et al. 2002; Bolker et al. 2009) to analyze the relationship between the life traits incidence to their exclusiveness or commonness to both land covers of each paired site. One model compared the incidence of traits which were shared and exclusive; another the incidence of traits which were only exclusive according to their land cover. Since our answer variables were qualitative and binomial, our model distributions were both binomial-fitted. The tested parameters were carabid life traits, as presented in Table 13. The wing status has been transformed into a continuous variable (), in order to be integrated in the models. The size has been standardized. We retained in our models the interactions of diet or wing status related to size of carabids. Size-diet interaction informs about the type of prey, whereas wing status-size interaction about the mobility of the species (Cole et al. 2002) . We also kept the year of sampling as a parameter. This resulted in the comparison of 14 different models, including null one.

Corrected Akaike information criterion (AIC_c) allowed to estimate the relative quality of every model in our sets (Symonds and Moussalli 2011). For each set, we selected the most parsimonious models,

i.e. whose ΔAIC_c was inferior to 2 in multimodel inference (Burnham and Anderson 2002; Burnham and Anderson 2004). When there was more than one model, we averaged them in order to retain as much information as possible on the significant explanatory variables (Burnham and Anderson 2002; Johnson and Omland 2004). We always checked the null model ΔAIC_c to verify the significance of our model selection (a ΔAIC_c lower than 2 involved no significant effect of explanatory variable). We used the R lme4 1.1-18-1 package (Bates et al. 2014) and the R MuMIn 1.42.1 package (Burnham and Anderson 2002; Barton 2018) for the multimodel inference procedure.

5.2.3.3. Relationship between species distribution, traits and landscape context

In order to disentangle the relationship between landscape context, species distributions and life traits, we performed RLQ analyses (Dolédec et al. 1996; Dray et al. 2003; Kleyer et al. 2012). RLQ provides double ordination between three datasets: R (landscape context), L (carabids abundance contingency table) and Q (species traits). We standardized our abundance contingency tables according to Hellinger (Legendre and Gallagher 2001) and then applied classical Euclidean distances calculations to obtain the ecological distances matrix. Compared to Jaccard or Bray-Curtis distances, Hellinger offers the advantage to lower dissimilarity in the case of rare species (in the whole dataset).

RLQ recommends to firstly analyze all the tables separately with the appropriate multivariate ordination method: covariance analysis (CA) for the carabid contingency table. Secondly, principal correspondence analysis (PCA) was performed for the landscape context table. Thirdly, multiple correspondence analysis (MCA), by Hill-Smith PCA was driven for the trait table, weighing columns with the previous PCA species scores. Finally, the RLQ analysis provides a combination of all three independent analyses. To test the robustness of the RLQ, we performed two Monte-Carlo randomization tests (Model 2 and 4, 9,999 permutations and $\alpha = 0.05$). For the first test, the null hypothesis was that species are distributed randomly across the sampled pairs, for the second test the null hypothesis was that species are distributed randomly, irrespectively to their traits (Dray and Legendre 2008; Dufлот et al. 2014). We used the R ade4 1.7-13 package for the RLQ analysis (Dray et al., 2018).

5.2.3.4. Landscape parameters

All the landscape parameters are the results of field recording within a radius of 500 m around every sampled site. We processed our data through ArcGIS 10.4 (Esri 2015) in order to obtain different landscape indicators for three different landscape radii (200, 300, 500 m) around the sampling points (Figure 23). To analyze the compositional heterogeneity of the landscape we applied the Shannon diversity index. It is calculated as follows: $H' = - \sum_{i=1}^n p_i \ln p_i$ where p_i is the proportional area of the i^{th} land cover among the n land covers in the corresponding radius areas around the sampling points.

The land cover types which were considered for the Shannon index are presented in Appendix A. The field border density, called in the following edge density, was measured by extracting the edges between land parcels and summing their total length in the three different radii areas. The winter crop-grassland edge density was obtained the same way, though it only considered the edges between adjacent parcels of winter crops and permanent grasslands. We tested the Spearman's rank correlation between the different landscape variables in every study area Appendix G, in order to interpret more confidently our results.

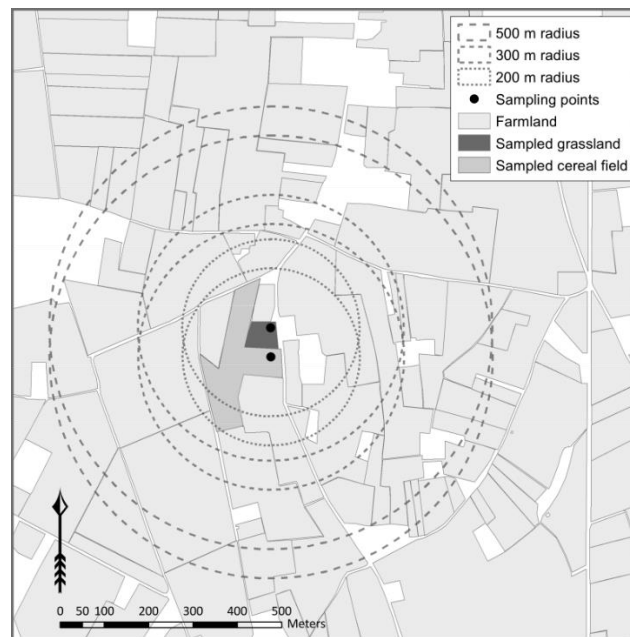

Figure 24. Different landscape context radii around the pairs of sampling points.

We performed a principal component analysis (PCA) with different landscape parameters for the 200, 300 and 500 m radii areas around sampling points to determine the most explanatory variables as well as their correlation to other variables. The PCA allowed the identification of a set of variables which described best the landscape context (Table 14). The variables included in the PCA were both configurational and compositional: coverage ratios of annual winter crops, annual spring crops, permanent grasslands, temporary grasslands, woodlands, linear semi-natural elements, hedgerows; compositional diversity measures such as number of different crops, the landscape Shannon diversity, and the crop Shannon diversity; and finally configurational indicators such as the mean field area, the mean field complexity index, the overall edge density and specific winter crop-grassland and winter crop-spring crop edge densities. We also integrated in the RLQ analysis the land cover type of the sampled field, in order to search for the potential differentiated impact of the landscape on the functional communities from grasslands and winter crops.

Table 14. Significant landscape parameters selected to analyze carabid species richness with generalized linear models comparison.

Parameter	Abbreviation in graphs	Type	Values / Metric
Grassland coverage ratio	grasslands	Continuous	Percentage of area
Hedgerows coverage ratio	hedgerows	Continuous	Percentage of area
Landscape Shannon diversity index ^a	Shannon	Continuous	Double
Edge density	ED	Continuous	m.ha ⁻¹
Winter crop – permanent grassland edge density	WC-PG ED	Continuous	m.ha ⁻¹

^aThe land cover types accounting for landscape Shannon index are presented in Appendix A.

5.3. Results

5.3.1. Life traits of common and exclusive species to paired cereal fields and grassland

Carabid species common to the two paired land cover types appeared in 14% of the analyzed pairs. (Table 15a). In the cereal crops they were exclusively found in 36% of the sampled pairs, in permanent grassland in 40% of the cases. The predatory carabids had the highest presence among diet traits. Phytophagous species came in second and polyphagous ones were the least sampled. Predatory carabids were appeared more often in both landcover types. Phytophagous species were a bit less sampled in both paired cereal crop and grassland than polyphagous while they were the group the most exclusive to grasslands. Polyphagous species were dominantly exclusively found in cereal crops, although they were relatively higher in both covers compared to the other two diet traits. More than the half of predatory species were exclusively present in cereal crop, although almost one third could also be sampled exclusively in grassland.

Concerning the wing status (Table 15b), macropterous species were the most present in numbers by far, whereas apterous and dimorphic species were sampled 9 and 5 times lower, respectively. Apterous species were relatively the most exclusive to grassland, though some of them had a low common presence in both land covers. Dimorphic species were the most dominant in cereal crops, whereas macropterous species were almost equally sampled exclusively in cereal crop and grassland.

Large carabids were the most abundant, followed by very small and small carabids. Medium-sized carabids were by far the least abundant. Large carabids were relatively more common to both land cover types with 18%, compared to the other size categories. Very small carabids were highly found

exclusively in cereal crops, with 57% of their abundance, although the level of large ones was high as well, with 48%. Medium-sized and, to a lesser extent, small carabids were the most found carabids exclusively in grasslands, with respectively 63 and 47% of their total abundance.

Table 15. Abundance of carabids in agricultural landscapes in southeastern France common or exclusive in grasslands and cropland in relation to traits: (a) diet (b) wing status and size.

(a)

	Overall		Diet					
	All traits		Phytophagous		Predatory		Polyphagous	
	n	%	n	%	n	%	n	%
Total	1179		399		597		399	
Common to both	164	14	36	9	89	15	36	9
Exclusive to cereal crops	541	46	87	22	338	57	87	22
Exclusive to grasslands	474	40	276	69	170	28	276	69

(b)

	Wing status						Size							
	Apterous		Dimorphic		Macropterous		very small (≤ 6 mm)		small ($>6-8$ mm)		medium ($>8-10$ mm)		large (> 10 mm)	
	n	%	n	%	n	%	n	%	n	%	n	%	n	%
Total	100		175		904		310		307		136		426	
Common to both	13	13	35	20	116	13	35	11	42	14	10	7	77	18
Exclusive to cereal crop	32	32	90	51	419	46	176	57	120	39	40	30	205	48
Exclusive to grassland	55	55	50	29	369	41	99	32	145	47	86	63	144	34

5.3.2. Distribution of life traits between the two land covers

Results from general linear mixed model inference are presented in Appendix I. Diet, and to a lesser extent size, of carabid species significantly explained their exclusiveness and commonness in our samples. When considering the exclusiveness of species to one sampled land cover, wing status and diet were important factors and size only mattered when interacting with one of the two other trait parameters.

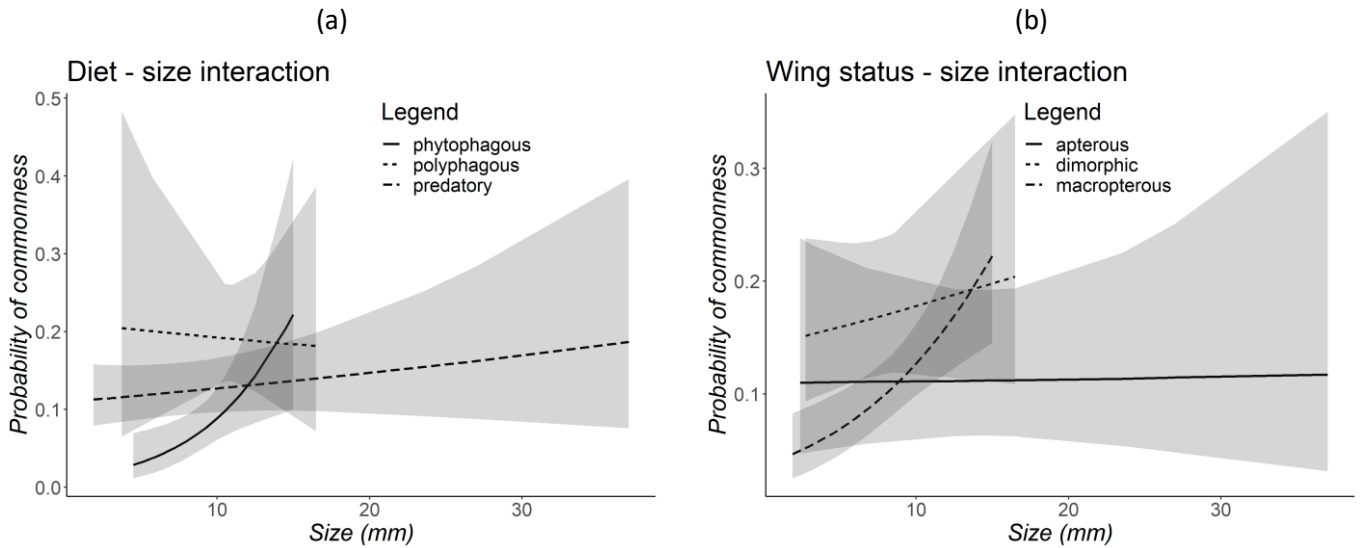

Figure 25. Species probability of commonness according to according to life traits and size: (a) diet and size, (b) wing status and size.

Note: $P(\text{exclusiveness}) = 1 - P(\text{commonness})$. Area around the curve is 0.95 margin error. The extremities of each curve mean no smaller or larger species was sampled for that peculiar trait.

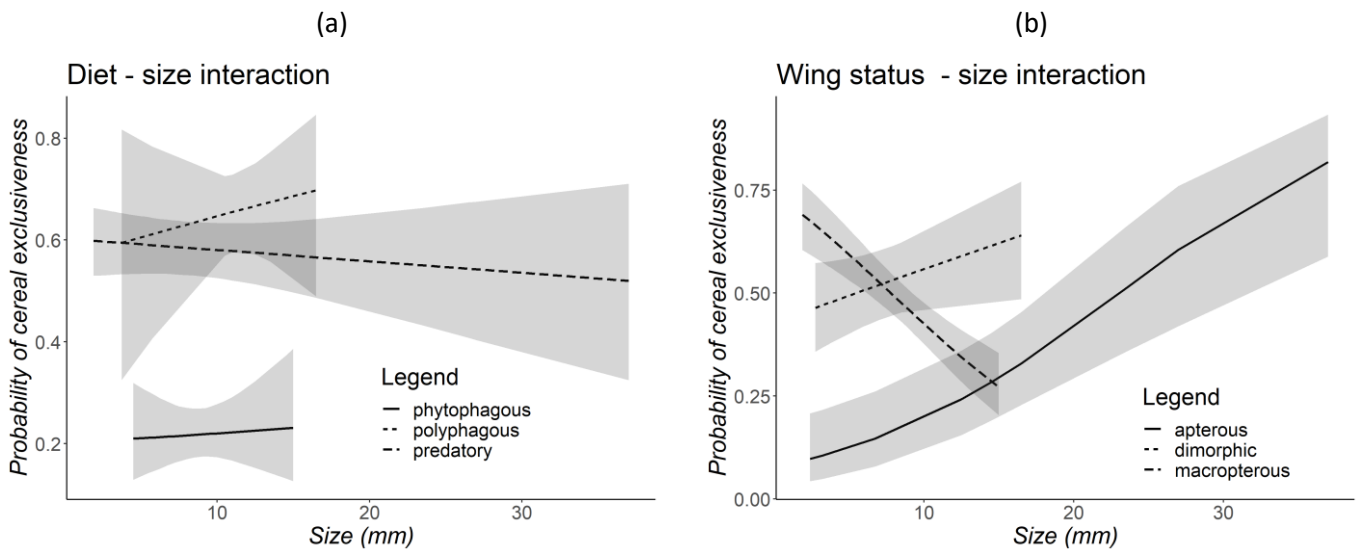

Figure 26. Species probability to be exclusive to one land cover type according to life traits and size: (a) diet and size, (b) wing status and size.

Note: $P(\text{PG exclusiveness}) = 1 - P(\text{WC exclusiveness})$. Area around the curve is 0.95 margin error. The extremities of each curve mean no smaller or larger species was sampled for that peculiar trait.

Polyphagous carabid species had the highest probability to be sampled in both grassland and cereal crop with increasing size of species, until to a certain size limit. Moreover, phytophagous tended to be occur more common to both land cover types when larger (Figure 25a). Dimorphic and macropterous species had also higher probabilities to be caught in both paired land cover types with increasing size of species, whereas apterous species were less common, irrespective to their size (Figure 25b).

Polyphagous and predatory carabids were more likely to be exclusive to cereal crops, while phytophagous species were highly exclusive to grasslands (Figure 26a). Apterous carabids larger than 25 mm had higher probabilities to be found exclusively in cropland, though smaller ones are more exclusive to grasslands (Figure 4b). Macropterous species showed a strong change regarding size with smaller macropterous species are more likely to be caught in the cereal crop only, and macropterous larger than 9 mm more caught exclusively in the grassland. Dimorphic species had equivalent likelihoods to be exclusively found in grassland and cropland, but with increasing size more found exclusively in cropland.

5.3.3. Landscape context influence on life traits

The land cover type was the most explanatory parameter of the carabid life traits occurrence. Landscape context was secondary, with the most important factors landscape Shannon diversity, edge density and grassland coverage. Indeed, the projected inertia of the RLQ first axes showed that the first axis explained 84% of the carabid traits variance (Figure 27). The second axis and the third axis respectively explained 9% and 4% of the carabid traits variance; they are more related to the difference in the 500 m radius landscape context between the sampled fields. The first two axes thereby explained 93% of the trait variance. The RLQ analysis showed that species compositions significantly depended on sampled habitat and landscape parameters (permutation test, p -value = 0.0001). However, the relationship between the distribution of species and their functional traits was slightly over the significance level (permutation test, p -value = 0.053).

The first axis significantly correlated with the land cover type of the sample: cereal crops or permanent grasslands (Figure 27). The combination of the second and third axis differentiated the 500 m landscape contexts through compositional and configurational heterogeneity parameters, with respectively landscape Shannon diversity and edge density (both overall and winter crop-permanent grassland).

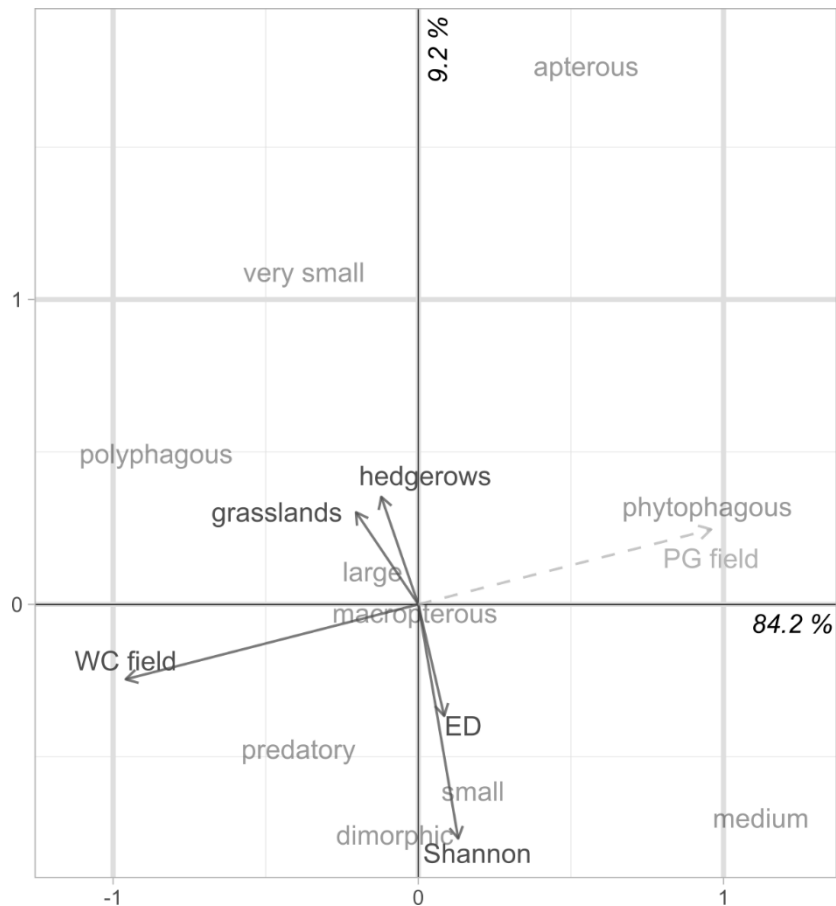

Figure 27. Ordination of the landscape parameters and carabid species traits along the two first axes of the RLQ analysis

Apterous species were typical of grasslands with low compositional diversity in their landscape context (Figure 27a). The presence of phytophagous species was related to grasslands. Very small species were bound to fields with a high grassland coverage in their landscape. Polyphagous presence was explained by cereal crops, with landscapes of relatively high grassland coverage and/or low landscape compositional diversity. Medium-sized species were related to grasslands in heterogeneous landscapes. Predatory species were bound to crop fields with high landscape heterogeneity. Macropterous species were not dependent of the habitat nor of the landscape context (Figure 27a and Figure 27b).

5.4. Discussion

In this study, we aimed at disentangling the influences of the sampling land cover type from the landscape context on the distribution of carabid life traits. Polyphagous species tended more to be commonly appearing in paired grassland and cereal crop. Phytophagous species were highly exclusive to grasslands, while predatory and polyphagous were it in cereal crops. Small apterous carabids were more likely to be caught in grasslands only. Polyphagous species were related to cereal crops when in vicinity of high grassland coverage. Finally, macropterous species were not influenced by the sampled land cover type nor the landscape context.

5.4.1. Polyphagous species are more shared by both land covers

As we expected in our *hypothesis (i)*, polyphagous species were more shared by both paired grasslands and cereal crops. Indeed, their polyphagy allows them to feed on invertebrate preys as well as weed seeds; they are thereby more likely to thrive in both land cover types (Thiele 1977; Luff 1996; Kromp 1999). Also, as they can move from one to another in case of disturbance or lack of resources (Östman et al. 2001b), they can spillover into grasslands after the harvest of crops, where they can eventually overwinter (Geiger et al. 2009; Alignier et al. 2014). Moreover, we found that polyphagous species were bound to high grassland coverage in the cereal crop surrounding landscape. It may be due to the fact that after hibernation they migrated back into cereal crops during spring, when the vegetative cover there is favorable again. And during this season, they can indeed find many of their potential preys, like aphids and snails, which are more present in cereal crops than in grasslands (Schneider et al. 2016).

5.4.2. Trait occurrence is primarily determined by the land cover type

Our second objective concerned the disentangling of field and landscape parameters in the determination of carabid traits. We thereby found that the main factor determining carabid traits was the land cover type, which is consistent with previous studies (Tuck et al. 2014; Caro et al. 2016; Gayer et al. 2019). We verified our *hypothesis (ii)*, as carnivorous species, identified as predatory and polyphagous in our diet trait categories, were related to cropland, probably due to the higher availability of pest preys such as aphids (Bryan and Wratten 1984; Holland et al. 2004; Winqvist et al. 2014; Hanson et al. 2016). Furthermore, we found more phytophagous species in grasslands, like Hanson et al. (2016), which is explained by the higher availability and diversity of vegetative food resource in this land cover type (Klimeš and Saska 2010; Diehl et al. 2012).

Small phytophagous were highly likely to be exclusive to grasslands, emphasizing their preference for this habitat. Indeed, we sampled in conventionally farmed cereal fields, where the weed cover was very low and mostly strongly controlled by herbicides (Labruyere et al. 2016). This might explain why fewer phytophagous species were found in cropland, since their food resource there was scarce compared to grasslands (Thomas et al. 2001). Yet, phytophagous are known to provide weed seed predation in monocrop landscapes (Jonason et al. 2013), though their assemblages are mostly composed of specialized species in this case (Kromp 1999).

Since we found that carabid wing status can be explained by the land cover type, our results are relevant with previous research works (Kromp 1999; Ribera et al. 2001). More precisely, Pedley and Dolman (2014) point out the level of disturbance, or management intensity, to be correlated with the wing status of the carabids. Then, we observed that macropterous species, with higher mobility due to their flight ability, are thereby indifferently found in one land cover type or another, being able to migrate in case of anthropogenic disturbance (Ribera et al. 2001; Hanson et al. 2016). This denied our *hypothesis (iii)*, which stated that mobile species would be more bound to crops. On the contrary, being less mobile, apterous are more typical to less disturbed land cover types, like permanent grasslands (Tilman and Downing 1994). Moreover, apterous species are known to be dominated by habitat specialists (Boer 1990). Since apterous carabids were caught in grasslands with high coverage of grasslands in their neighboring, it is likely that they were grassland specialists according to Batáry et al. (2007).

Carabid species found in cropland are usually ubiquitous, though some record showed that in organically farmed fields, species composition is closer to a grassland one (Kromp 1989; Kromp 1999). However, large species are known to be negatively impacted by intensive agricultural management, since their flight ability is limited, despite being macropterous. Hanson et al. (2016) found that emerging individuals after winter are affected by this selection of species of smaller size in croplands. Indeed, we found that smaller apterous species were more likely to be found exclusively in the grasslands. This can be the consequence of tillage mortality, which is higher among large carabids than smaller ones (Rusch et al. 2013a) or/and of overwintering of large carabids in more stable surrounding habitats (Wissinger 1997). However, cereal crops can host larger carabids from spring to autumn. Indeed, we found that macropterous species were not more sampled in grasslands than in cereal crops. This can be due to individuals which migrated in the cereal crops after the spring emergence (Hanson et al. 2016).

5.4.3. Landscape isolation endangers grassland specialists

The trait assemblages of carabids were secondarily determined by landscape descriptors, according to two gradients. The first gradient is the landscape heterogeneity, considering both compositional and configurational indices, respectively shown through the Shannon diversity and edge-density. Our second gradient is the semi-natural landscape elements coverage, including grasslands and hedgerows.

We only partially confirmed our *hypothesis (iv)* since we found that apterous species were correlated with landscape contexts of low compositional heterogeneity, hence dominated by a lower diversity of habitats. We indeed expected to find species less specialized in grasslands from heterogeneous landscapes, which also involved phytophagy. However, we already pointed out that apterous species were more typical to grassland samplings in our study. Moreover, they were not related to landscapes highly covered with semi-natural elements. Since apterous species are less mobile, they can face two different situations when they are in grasslands within homogeneous landscapes. First possibility is that they are surrounded by grasslands, second is that they are surrounded by a lowly diverse crop mosaic in an isolated grassland.

Species with weaker flight ability, hence lower mobility are more affected by habitat fragmentation (de Vries et al. 1996; Henle et al. 2004; Hendrickx et al. 2007). Thus, there may be a conservation concern with isolated grassland and low mobility species. Indeed, in case they are surrounded by croplands, with no or few refuges in their neighboring environment in case of disturbance of their habitat, they can thereby face local extinction (Hendrickx et al. 2009). This conservation issue is even more pronounced since isolated grasslands are subject to the spillover of more ubiquitous species from neighboring arable fields, which then might put at risk specialized grassland carabids to extinction because of strong competition on their resource (Boer 1990; Hendrickx et al. 2009; Wamser et al. 2012). This might be why Batáry et al. (2007) observed higher generalist species richness in grasslands surrounded by crops.

On the contrary, polyphagous species were more sampled in landscapes with low heterogeneity, either configurational or compositional, and high grassland coverage. Since they are usually generalist species, polyphagous can feed on a broad variety of resources and hence can be relatively more present in simple landscapes than other species. This is relevant with the results of Gámez-Virués et al. (2015), who observed that the simplification of the landscape leads to the homogenization of functional traits towards generalist species, especially polyphagous diet. Marrec et al. (2017) however

emphasized that polyphagous species were favored by higher crop coverage due to resource concentration in landscapes dominated by arable fields.

5.5. Conclusion

Our research emphasizes the need for grassland preservation and/or restoration in farmland to conserve carabid trait diversity. Indeed, grasslands host specialist species whose survival depends only on this habitat and cannot disperse due to poor mobility ability (Wamser et al. 2012). Moreover, grasslands are also interesting for generalist species from neighboring crops since they can be refuge habitats in case of agricultural disturbance or for overwintering. There is thus a strong need for land use planners to consider the importance of grasslands for ordinary farmland biodiversity in agricultural landscapes.

6. Landscape and field parameters, spiders and pollinators

6.1. Introduction

Carabids are of great interest for biological control through pest predation, but other arthropod groups are important as well, like spiders, hoverflies or lacewings (Emmerson et al. 2016; Altieri et al. 2018). The intensification of agriculture and the resulting simplification of landscapes also impacted negatively on this arthropod diversity (IPBES 2018b; Dainese et al. 2019). Among all the consequences of landscape simplification, the decline of grasslands and other semi-natural habitats is a major one.

Spiders are generalist insect predators, feeding mostly on collembolas, aphids, thrips and small flies, which makes them polyvalent pest regulators, though most of their preys are aphids in Europe (Sunderland et al. 1986; Nyffeler and Sunderland 2003; Moonen and Bärberi 2008). Among the diversity of spider families, two dominate the farmland communities: wolf spiders (Lycosidae) and money spiders (Linyphiidae) (Ekschmitt et al. 1997). Higher non-crop areas in the landscape enhance the activity-density of these two major spider families in cropland (Schmidt et al. 2008). However, wolf spiders, as ground-dwelling hence low-dispersive, are less affected by the landscape context than money spiders, since the latter are aeronautic web-builders, thereby highly dispersive (Uetz et al. 1999; Schmidt et al. 2008). The species richness of spiders is though highly related to the presence of semi-natural habitats. Indeed, non-crop habitats allow spiders to find refuges in case of disturbance as well as more secured nesting places than cropped fields (Concepción et al. 2012; Gallé et al. 2018a).

Hoverflies (Syrphidae) provide multiple ecosystem services to agriculture; since their larvae can be aphid predators or decomposers while the adult hoverflies are pollinators only (Moonen and Bärberi 2008; Moquet et al. 2018). Hence, the availability of foraging resources for both adults and larvae are necessary to hoverflies. Larvae indeed need a diversity of microhabitats, even woody areas, at the landscape scale, whereas adults need floral diversity at the plot scale (Moquet et al. 2018). Moreover, hoverflies tend to feed on understory plants of hedgerows (Garratt et al. 2017). Pollinators are highly related to floral diversity since they need to find a continuous food resource across time (Le Féon et al. 2010; Cole et al. 2017). Summer appears to be a crucial period for their survival since it is impoverished in floral diversity: semi-natural habitats, including road verges and riparian buffer strips, are good providers of continuous floral richness across time (Cole et al. 2017).

Like hoverflies, lacewings (Chrysopidae) provide multiple ecosystem services to agriculture. The larvae are generalist predators, known to be efficient in the control of aphids. Adult lacewings can be considered both as aphid natural enemies and pollinators, since they also feed on nectars and pollens

(McEwen et al. 2007). The specific relationship between landscape and lacewing communities has been less studied. However, there is evidence that semi-natural areas within agricultural contexts can favor their diversity and activity-density (McEwen et al. 2007). Indeed, according to the landscape complementation hypothesis, semi-natural areas provide alternative resource to croplands, such as complementary foraging or refuge and nesting habitats.

Grasslands thereby are important drivers to enhance the diversity of spiders, hoverflies and lacewings in farmland. Then, we aimed at checking how these 3 groups communities respond to field and landscape parameters in paired and adjacent cereal crops and grasslands.

In this chapter, we wanted to disentangle the influence of field parameters and landscape context on three different arthropod groups from neighboring pairs of grasslands and cereal crops. First, we focused on the spider activity-density and family richness from each land cover type. Then, we studied separately the activity-densities of two groups with multiple benefits for agriculture: hoverflies and lacewings.

6.2. Material and methods

6.2.1. Study regions

Our study was carried out in three agricultural plains of the Auvergne Rhône-Alpes region in southeastern France (Figure 28). The three study regions, Forez, Bièvre and Rovaltain are dominated by conventional farming. Like in other parts of France, it is characterized by management using tillage (mostly between 20 and 25 cm deep) (Labreuche et al. 2011), chemical fertilization, as well as preventive application of pesticides, fungicides and herbicides (Butault et al. 2011). On arable land, spring crops and winter cereals occupy almost the same share. However, the three study regions had various proportions of grassland and winter cereal field (Table 16). The Forez study region is covered with 27% of permanent grasslands, whereas Bièvre had 16% and Rovaltain only 3%. The major winter cereals were wheat and barley. Spring crops were maize, sunflower and soybean. Average field size was 1.96 ha in Bièvre study region, 2.06 ha in Rovaltain and 2.89 ha in Forez. Typically, winter cereals are sown in fall and harvested in June and July while spring crops are sown in April and May and harvested during late September and October. Winter cereals are cropped with at least one precautionary herbicide spraying, before or after winter, and one fungicide during spring. The use of pesticides can be more intense and is variable according to annual and local climate conditions. Permanent grasslands are managed by mowing two to three times and sometimes grazing. Rovaltain

and Forez have approximately the same woody coverage relative share, whereas in Bièvre it is slightly higher, mostly due to the north and south foothills which border the agricultural plain.

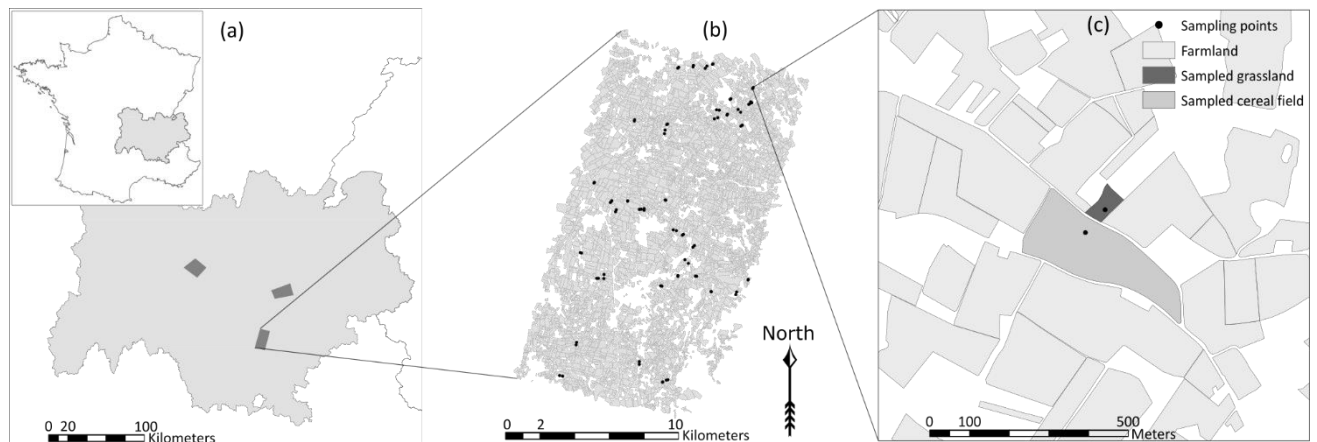

Figure 28. Locations of (a) the three study regions in the Auvergne Rhône-Alpes region, France, (b) sampling points (either cereal field or grassland) in the Rovaltain study region, and (c) example of sampling sites in neighboring paired cereal fields and grasslands.

Table 16. Land cover characteristics of the three study regions in southeastern France.

Study region	Whole study region		Farmland ^b		Winter cereals		Spring crops		Other farmland ^a		Permanent grasslands		Woodland ^c	
	ha	%	ha	%	ha	%	ha	%	ha	%	ha	%	ha	%
Rovaltain	23,030	100	15,550	68	6,070	26	5,010	22	3,873	17	597	3	2,672	12
Bièvre	23,949	100	15,363	64	4,389	18	4,034	17	3,153	13	3,787	16	3,779	16
Forez	25,002	100	15,555	62	2,428	8	2,634	11	3,745	15	6,749	27	2,729	11

^a By importance of area: temporary grasslands, rapeseed, orchards and vineyards

^b Including temporary and permanent grasslands

^c Forests, woods and groves

6.2.2. Site selection and insect sampling

We selected two contrasting agricultural land cover types corresponding to different intensities of management and inputs: winter cereals and permanent grasslands. Winter cereals were the most common among croplands when considering the three study regions (Table 16). Sampled cereal fields were primarily cropped with wheat and barley and in a few cases with triticale and rye. Most fields were tilled and farmed with synthetic inputs. Another important agricultural landscape in this study were permanent grasslands, these are especially important for livestock farming. For analyzing spiders and pollinators occurrences, we placed one combined trap per cereal field and grassland.

As we wanted to study the distinction between the communities from the two contrasted land covers, we selected couples of sampling sites where cereal and grassland fields were adjacent or in close

vicinity, allowing for similar landscape context. In 2017, 84 sites were sampled, with 43 cereal fields and 41 nearby grasslands. In 2018, there were 122 sites sampled with 61 cereal fields and 61 grasslands. We had two more samples in cereal fields than in grasslands due to the destruction of our traps by cattle; in this case, they were removed from any paired analysis. Our traps were combined in order to sample both ground-dwelling spiders with pitfall traps as well as flying pollinators with sticky flight traps (Figure 29).

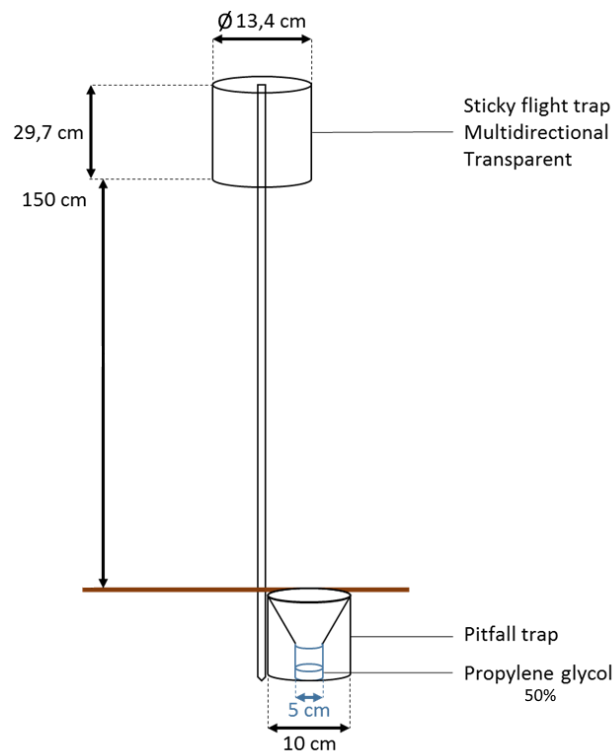

Figure 29. Paired flight and pitfall traps

Spiders were sampled with pitfall traps (10 cm diameter) half-filled with a 50% propylene glycol solution. A drop of detergent was added to reduce surface tension and then prevent the escape of lighter spider species. Polystyrene roofs (22 cm diameter) were set about 5 cm above each trap to prevent flooding of traps during rainfall events. In order to sample flying insects, we set flight sticky traps. We wanted our trap to be neither attractive nor directional, though most traps used to sample pollinators cumulate both characteristics. The transparent interceptor trap is the best to sample pollinators such as hoverflies and bees (Muirhead-Thompson 2012). We thereby modified the classic transparent interceptor trap in order to fit our sampling objectives, plus having a lighter design to prevent destruction from agricultural practices. Interceptors were transparent sheets (A3, 42 cm wide and 59.4 cm high) rolled into cylinders in order to catch insects coming from any direction. Transparency of the interceptor responded to the necessity of non-attractivity. The sheet was coated

with glue to trap insects. Identification of spiders at the family level followed the keys of Nentwig et al. (2017). Hoverflies and lacewings were identified at the family level following Villenave-Chasset (2017).

The combined traps were set with at least 30 m to the field border to limit edge effects. Each year, two field surveys were carried out with sampling periods of seven days. The first period was between late April and early May, and the second was between late May and early June.

6.2.3. Data analysis

6.2.3.1. Diversity and activity-density indicators

For data analysis, we selected different diversity indicators in order to describe the communities. For spiders, we studied the per trap family richness and activity-density we sampled in the permanent grasslands and in the cereal crops. Concerning pollinators, we counted the activity-density of hoverflies and lacewings caught on the sticky flight trap per field. We grouped the sampling data of the first and the second sampling periods in order to summarize the whole diversity of carabids present each year in spring.

6.2.3.2. Landscape explanatory parameters

All the landscape parameters are the results of field recording within a radius of 500 meters around every sampled site. We processed our data through ArcGIS 10.4 (Esri 2015) in order to obtain different landscape indicators for three different landscape radii (200, 300, 500 m) around the sampling points (Figure 30). To analyze the compositional heterogeneity of the landscape we applied the Shannon diversity index. It is calculated as follows: $H' = -\sum_{i=1}^n p_i \ln p_i$ where p_i is the proportional area of the i^{th} land cover among the n land covers in the corresponding radius areas around the sampling points. The land cover types which were considered for the Shannon index are presented in Appendix A. The field border density, called in the following edge density, was measured by extracting the edges between land parcels and summing their total length in the three different radii areas. The winter crop-grassland edge density was obtained the same way, though it only considered the edges between adjacent parcels of winter crops and permanent grasslands. We tested the Spearman's rank correlation between the different landscape variables in every study region (Appendix G), in order to interpret more confidently our results.

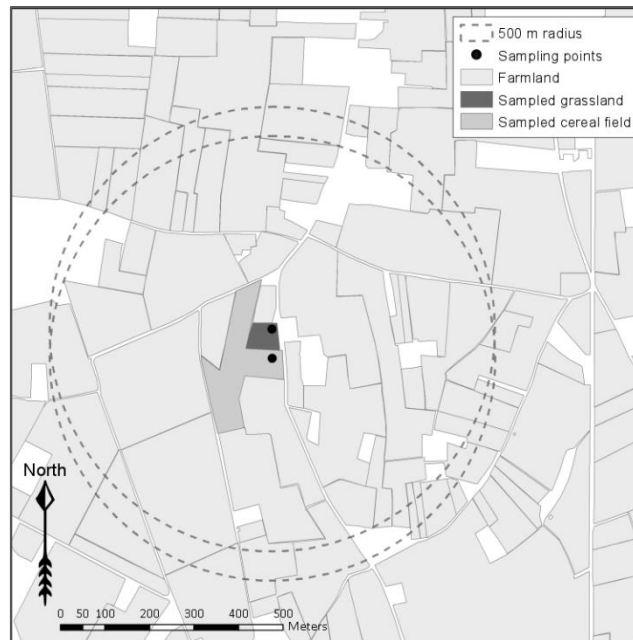

Figure 30. Example of 500 m landscape context radius around a pair of paired fields.

We performed a principal component analysis (PCA) with different landscape variables for the 500 m radius area around sampling points to determine the most explanatory variables as well as their correlation to other variables. The PCA thus allowed the identification of a few variables which described best the landscape context (Table 9). The variables included in the PCA were both configurational and compositional: coverage ratios of annual winter crops, annual spring crops, permanent grasslands, temporary grasslands, woodlands, linear semi-natural elements, hedgerows; compositional diversity measures such as the number of different crops, the landscape Shannon diversity, and the crop Shannon diversity; and finally configurational indicators such as the mean field area, the mean field complexity index, the overall edge density and specific winter crop-grassland and winter crop-spring crop edge densities. Although we retained the grassland coverage from the PCA and not the cropland coverage, it is important to notice that both parameters were strongly inversely correlated (Spearman’s rank correlation p -value < 0.001 and $\rho = -0.79$).

6.2.3.3. Analysis of insect biodiversity

Statistical analyses were conducted using R 3.6.0 (R Development Core Team 2019). We tested the impact of landscape variables (Table 17) with generalized model comparison (Guisan et al. 2002). We used the “MuMin” package for the multi-model inference analyses (Barton 2018), “ade4” for the multivariate analyses (Dray et al. 2018). Three different sets of 15 models were fitted altogether, one set for every tested radius. The full model included a combination of two additive terms from the five explanatory parameters to which we added their interaction with the study region and the additive

effect of the sampling year. Models with more than two explanatory parameters were beforehand tested, but none was more significant than those we retained for the final analysis.

Table 17. Selection of significant landscape parameters selected to analyze carabid species richness with generalized linear models comparison.

Parameter	Abbreviation in graphs	Type	Values / Metric
Grassland coverage ratio	grasslands	Continuous	Percentage of area
Hedgerows coverage ratio	hedgerows	Continuous	Percentage of area
Landscape Shannon diversity index ^a	Shannon	Continuous	Double
Edge density	ED	Continuous	m.ha ⁻¹

^a The land cover types accounting for landscape Shannon index are presented in Appendix A.

The spider family richness model was fitted Gaussian distribution error, whereas the spider activity-density and pollinators activity-density models were fitted with Poisson distribution errors. We used the Akaike Information Criterion corrected for small sample size (AIC_c) to select models offering the best compromise between fit and simplicity (i.e., the most parsimonious model) (Symonds and Moussalli 2011). For each explained variable we selected the most parsimonious models, *i.e.* whose ΔAIC_c was inferior to 2 (Burnham and Anderson 2002; Burnham and Anderson 2004). When there was more than one model, we averaged them in order to retain as much information as possible on the significant explanatory parameters (Burnham and Anderson 2002; Johnson and Omland 2004). We always checked the null model ΔAIC_c to verify the significance of our model selection (a ΔAIC_c lower than 2 involved no significant effect of explanatory parameter).

6.3. Results

6.3.1. Spider family richness activity-density

We caught 10,084 spiders from 22 different families (Table 18). We captured 4,393 individuals in cereal crops and 5,691 in the permanent grasslands. Although we sampled equally in grasslands and cereal crops in Rovaltain and Forez, we caught 1,000 more individuals in the grasslands of Bièvre than in cereal crops. The overall family richness we sampled were similar in Bièvre and Forez, 16 considering both land cover types, and was a little higher in Rovaltain with 18 different families in this region. The average number of caught spiders per field was higher in the grasslands than in cereal crops in both Bièvre and Forez, whereas in Rovaltain, we captured 54 individuals in both land cover types.

Concerning the average family richness per field, were about 4.5 in the crops and 5.5 in the grasslands in both Bièvre and Forez, though it was a little lower in Rovaltain, with 3.9 in crops and 5 in grasslands.

Table 18. Diversity and activity-density of spiders in winter cereal fields and permanent grasslands in the three study regions.

	Number of sampled fields	Activity-density (individuals)	Family richness	Per field activity-density (individuals)		Per field family richness	
				Mean	± SD	Mean	± SD
All study regions							
Winter cereal	104	4,393	19	43	± 25	4.3	± 1.1
Perm. grassland	102	5,691	21	56	± 32	5.5	± 1.3
Both land cover types	206	10,084	22	49	± 29	4.9	± 1.4
Bièvre							
Winter cereal	33	1,504	12	47	± 21	4.6	± 1.2
Perm. grassland	32	2,504	15	78	± 40	5.4	± 1.1
Both land cover types	65	4,008	16	63	± 36	5.0	± 1.2
Forez							
Winter cereal	30	1,559	11	32	± 19	4.3	± 1.1
Perm. grassland	29	1,563	15	40	± 21	5.9	± 1.4
Both land cover types	59	3,122	16	36	± 20	5.1	± 1.5
Rovaltain							
Winter cereal	41	1,330	16	54	± 30	3.9	± 0.9
Perm. grassland	41	1,624	18	54	± 20	5.0	± 1.3
Both land cover types	82	2,954	18	54	± 26	4.5	± 1.2

Considering both land cover types, the two most sampled families were wolf spiders (Lycosidae) with 66% of the individuals, and money spiders (Linyphiidae) with 15% (Table 19). Third most sampled family were the ground spiders (Gnaphosidae) with 7% and the other 19 families thereby merely shared 12% of the total sample. In the cereal crops, wolf spiders were highly dominant with 65% of the individuals, even though money spiders were rather well represented as well with 24%, whereas all the 20 other families share only 11% of the sampled individuals. In the grasslands, even though the wolf spiders are highly dominating with 66% of the activity-density, the distribution among the other families is quite different than in cereals, since the ground spiders come in second, with 10% of the individuals, just before the money spiders with 9%.

Table 19. Distribution of the 10 most sampled spider families by land cover type and family.

	Both land cover types		Winter cereal		Permanent grassland	
	%	Rank	%	Rank	%	Rank
Lycosidae	66	1	65	1	66	1
Linyphiidae	15	2	24	2	9	3
Gnaphosidae	8	3	5	3	10	2
Tetragnatidae	5	4	3	4	6	4
Thomisidae	3	5	2	5	4	5
Theridiidae	1	6	1	6	2	6
Zodariidae	<1	7	<1	9	1	7
Phrurolithidae	<1	8	<1	7	<1	10
Hahniidae	<1	9	<1	15	<1	8
Philodromidae	<1	10	<1	10	<1	9

We observed two parameters were important to determine the spider family richness: the sampled land cover type and the study region (Appendix K.1). The family richness was consistently higher in grasslands than in cereal fields (Figure 31). However, the most parsimonious generalized linear model alleged that Rovaltain family richness is slightly lower than in Bièvre and Forez, this effect is so weak that it did not appear on our chart. No landscape parameter had influence on the spider family richness.

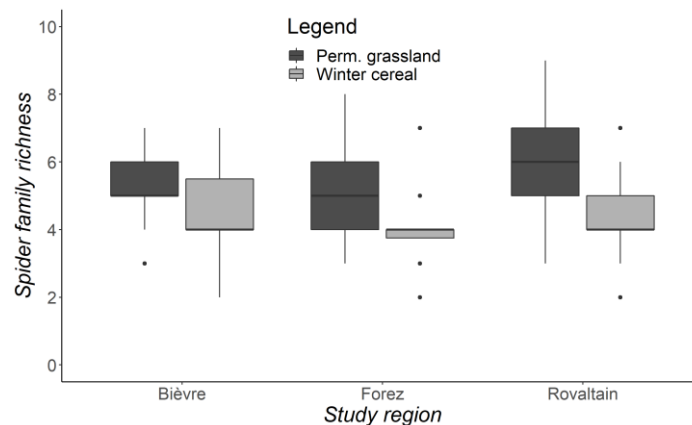

Figure 31. Significant parameters and interactions effects of the spider family richness model analysis in the three study regions

Note: In boxplots, symbols are: middle line=median; open rectangle=25-75% quartile; vertical bar=non-outlier range; black points=outliers.

Concerning the spider activity-density, many parameters appeared to be of importance (Appendix K.2), including both local, regional and landscape factors. The most important parameter was the land cover type: we caught more spiders in grasslands than in cereal crops (Figure 32a). Moreover, the positive

influence of higher edge density in the 500 m landscape radius was only observable in the grasslands. The grassland coverage in the landscape increased the number of captured individuals in both sampled land cover types (Figure 32b), whereas the compositional heterogeneity of the landscape had a negative effect only on cereal fields samples (Figure 32c). The hedgerow coverage influenced negatively the spider activity-density in cereal crops, but not in grasslands (Figure 32d).

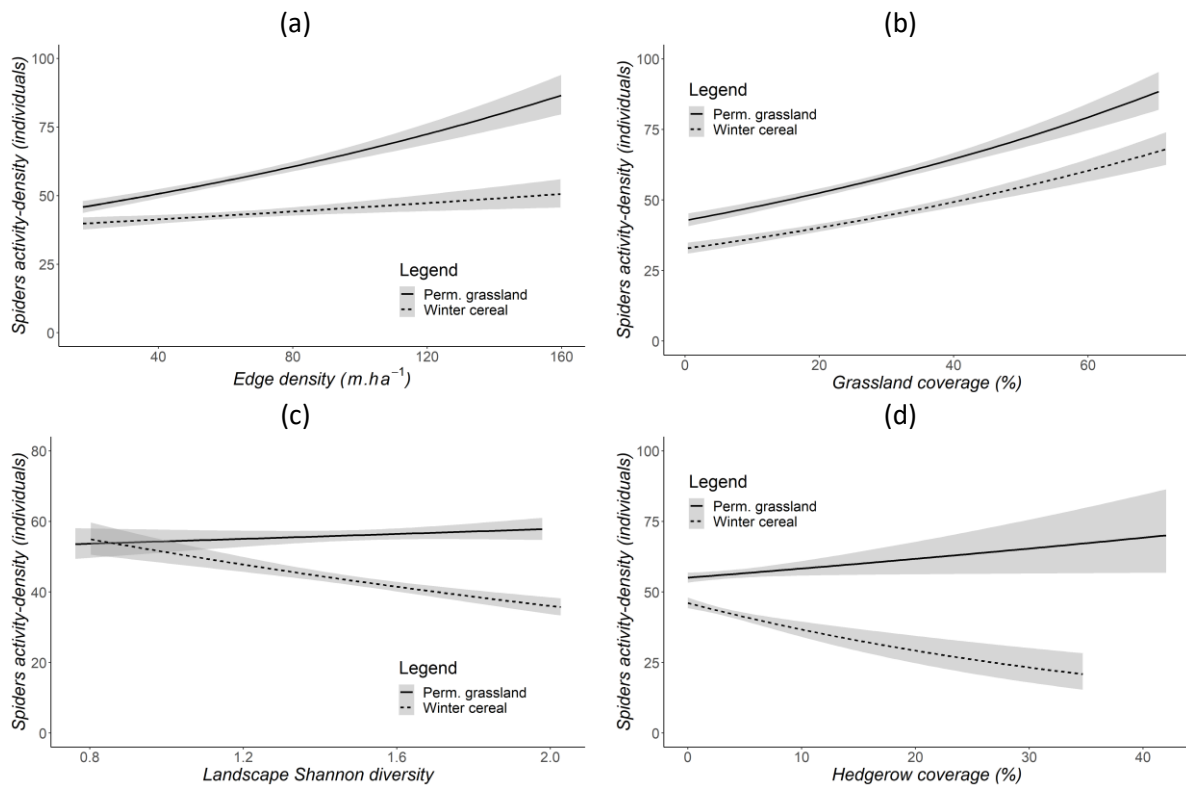

Figure 32. Significant parameters and interactions effects of the spider activity-density model analysis in the three study regions: (a) sampled field size, (b) grassland coverage^a and sampled field land cover type, (c) landscape Shannon diversity^a and sampled field land cover type, (e) hedgerow coverage^a and sampled field land cover type.

^a All landscape context parameters are from the 500 m radius.

Note: In line charts, area around the curve is the 0.95 margin error.

6.3.2. Hoverfly activity-density

Hoverfly activity-density was mainly determined by the sampled land cover type, the study region and the grassland coverage in the neighboring 500 m (Appendix K.3). We caught a total of 550 hoverflies, among which 65% were from cereal crops and 35% from grasslands. The multimodel inference selection showed that both local and landscape parameters had a significant influence on the number of caught hoverflies (Appendix K.3). Indeed, the activity-density of hoverflies was lower in grasslands (Figure 33a, b and d). Moreover, the grassland coverage around the sampled field decreased the number of captured hoverflies from both land cover types (Figure 33a). The sampled field size

decreased the number of surveyed hoverflies only in permanent grasslands (Figure 33b). We observed a higher hoverfly activity-density in Rovaltain than in the two other study regions, moreover, whereas the grassland coverage in the neighboring 500 m decreased the activity-density of hoverflies in Bièvre and Forez, it had a positive effect in Rovaltain (Figure 33c). Finally, the configurational heterogeneity of the landscape had a stronger negative influence on the activity-density of hoverflies in grasslands than in winter crops (Figure 33d).

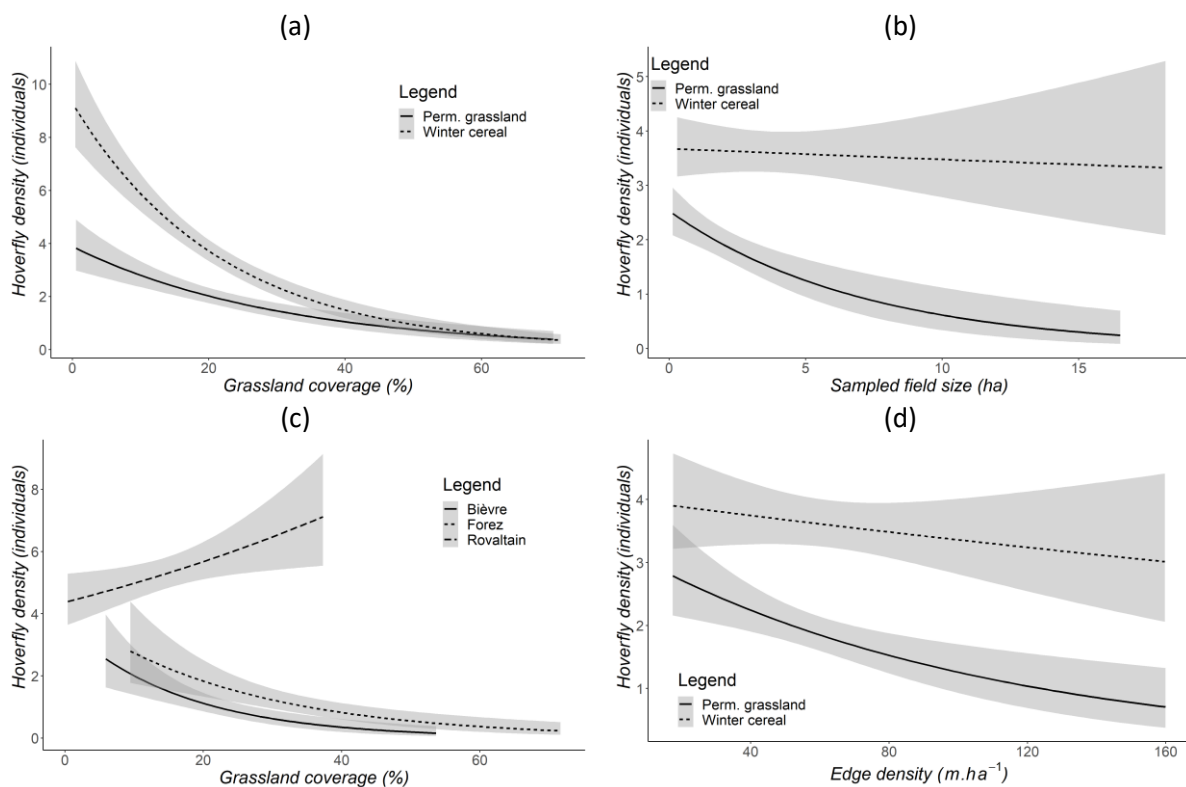

Figure 33. Significant parameters and interactions effects of the hoverfly activity-density model analysis in the three study regions: (a) grassland coverage^a and sampled field land cover type, (b) sampled field size and land cover type, (c) grassland coverage^a and study region, (d) edge density^a and sampled field land cover type.

^a All landscape context parameters are from the 500 m radius.

Note: In line charts, area around the curve is the 0.95 margin error.

6.3.3. Lacewing activity-density

Grasslands had a negative influence on lacewing activity-density, both as sampled land cover type and coverage in the neighboring 500 m, though the year of sampling had a strong influence as well (Appendix K.4). We captured 554 lacewings overall, among which 63% in cereal fields and 37% in grasslands. The grassland coverage in the neighboring 500 m negatively impacted on the sampled number of sampled lacewings (Figure 34a). Whereas we caught lacewings equally in the smaller fields of grassland or cereal crop, we captured more lacewings in larger cereal fields and fewer in larger

grasslands (Figure 34b). Concerning the hedgerow coverage, it increased the number of caught lacewings in grasslands, though it lowered it in cereal crops (Figure 34c). Finally, we sampled generally less lacewings in 2018 than in 2017 (Appendix K.4).

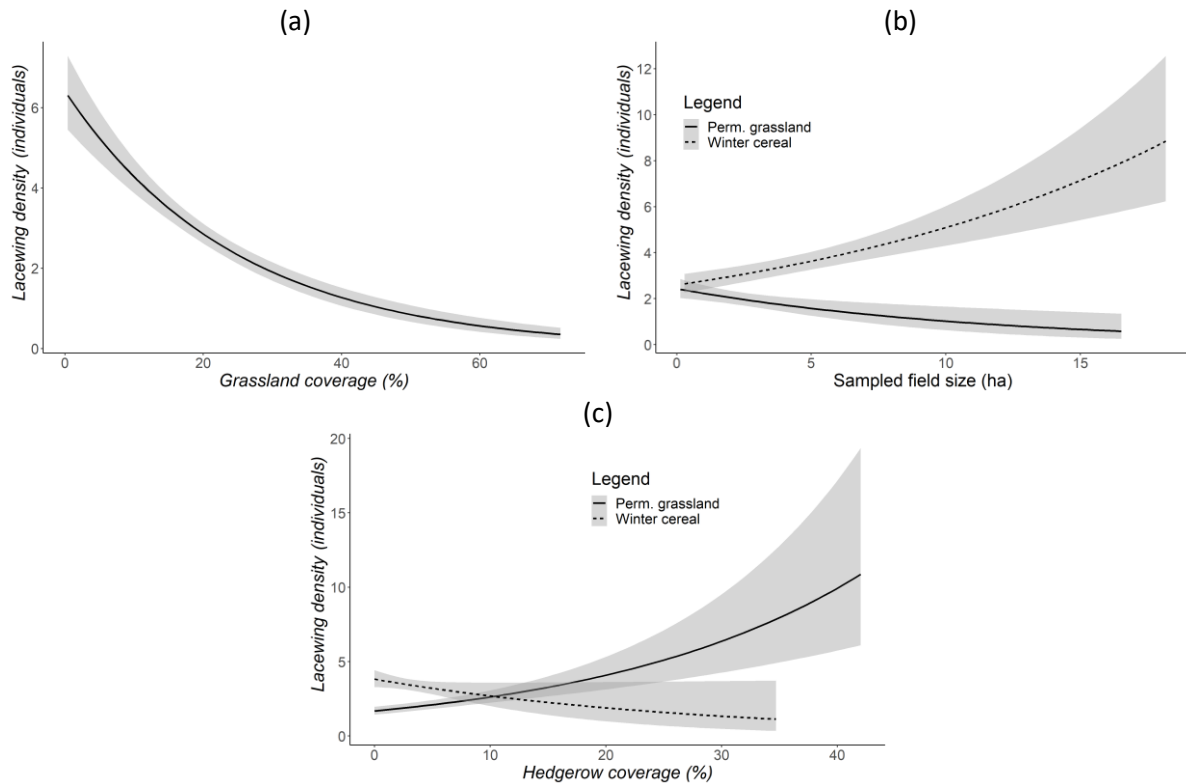

Figure 34. Significant parameters and interactions effects of the lacewing activity-density model analysis in the three study regions: (a) grassland coverage^a, (b) sampled field size and land cover type, (c) hedgerow coverage^a and sampled field land cover type.

^a All landscape context parameters are from the 500 m radius.

Note: In line charts, area around the curve is the 0.95 margin error.

6.4. Discussion

In this chapter, we analyzed the influence of local, regional and landscape parameters on different spider and pollinator biodiversity indicators. We observed that the spider species richness was dependent of the sampled land cover type and the study region. However, the spider activity-density was impacted by a much broader spectrum of parameters, including both sampled field and landscape parameters, such as semi-natural coverages or configurational and compositional heterogeneities. Hoverfly sampled activity-density was mainly determined by the sampled land cover type, the study region and the grassland coverage in the neighboring 500 m. Finally, the number of captured lacewings

was lower in grasslands than in cereal fields, but also lower with higher coverage of grasslands in the neighboring 500 m.

6.4.1. Spider family richness was not determined by landscape parameters

Like in other studies (Concepción et al. 2008; Batáry et al. 2012), we observed the importance of the sampled field for spider richness over landscape parameters. It is possibly due to the low mobility of ground-dwelling species (Duelli et al. 1990). Indeed, 74% of the spiders we caught were ground-dwellers, since the most sampled family, the wolf spiders, represented 66% of the captured individuals, and the ground spiders were 8%.

However, previous studies pointed out the importance of landscape context for spider species richness. This can demonstrate one limit of our work, since we only identified the spiders to the family taxon level. It has been indeed showed that both edge type and landscape compositional heterogeneity are important to enhance spider species richness. Field boundaries harboring hedgerows and non-crop habitats in general also favor higher spider diversity (Concepción et al., 2012; Schmidt et al., 2005). Furthermore spider species richness is increased by both lower land-use intensity and higher semi-natural vicinity (Hendrickx et al. 2007). They indeed provide safe nesting places and overwintering habitats as well as complementary foraging resource (Dennis et al., 1994; Schmidt et al., 2005). This can thereby explain why we sampled a higher family richness in grasslands than in cereal fields.

6.4.2. Grasslands enhances the number of spiders

We sampled more spiders in fields from landscapes with higher grassland coverage, which is relevant with previous works: non-crop habitats, even small ones, enhance the activity-density of spiders in farmland (Knapp and Řezáč, 2015; Schmidt et al., 2005). Otherwise, within field grassy strips can provide refuge and overwintering habitats for ground-dwelling spiders, and then help them to recolonize crops faster, which enhances the efficiency of the biological control they provide (Lemke and Poehling 2002). This observation may be extended to the adjacency of grasslands to croplands, as they provide the equivalent resource than grassy strips. Indeed, small-scale agriculture promotes cropland spider density (Gallé et al. 2018a), as well as the vicinity of semi-natural areas (Schmidt et al. 2008).

Moreover, the activity-density of the two most represented families in our samples, wolf and money spiders, is enhanced in cropped fields from landscapes with higher semi-natural coverage (Gardiner et al. 2010). However, wolf spider activity-density is enhanced by non-crop habitats in the surrounding

landscapes at much lower scales, hundreds of meters, than money spiders, up to 3 km (Schmidt et al., 2005). Being aerial dispersers through web threads, money spiders have indeed higher mobility than ground-dwelling wolf spiders.

Like Schmidt and Tschardtke (2005), we found that the domination of wolf spiders over money spiders is much higher in grasslands than in crops. Moreover, we observed that the second most captured family in grasslands were ground spiders, involving that more than 75% of the sampled spiders in grasslands were ground-dwellers. Aerial dispersers like money spiders are influenced by landscapes at much higher radii than ground-dwelling ones (Schmidt et al., 2005; Schmidt and Tschardtke, 2005b). The winter cereal spider density was diminished in more compositionally heterogeneous landscapes. In our study, compositional heterogeneity of landscapes mostly referred to the diversity of crops. It then means that higher landscape diversity means different crops, and possibly different vegetative development stages. Hence, the adjacency between winter and spring crops for instance can break the canopy continuity needed by money spiders to disperse properly.

More spiders were caught in cereal fields when there was a lower hedgerow coverage in the surrounding landscape. Money spiders and wolf spiders benefit differently from hedgerows: the first one need a continuity of hedgerows, though the second ones are favored by the presence of woody species within the hedgerows (Garratt et al. 2017). Thereby, it is possible that the hedgerows which were around our sampled cereal fields were not continuous enough for money spiders, even though they covered quite large areas.

One main bias of the pitfall traps is that they tend to catch more individuals when the soil is bare or lowly grassy, because they catch the moving individuals; that is typically why we refer to activity-density instead of real activity-density (Sunderland et al. 1995; Lang 2000). Yet, we caught more spiders in grasslands than in cereal crops. It is even likely that the actual activity-density of spiders in grasslands has been underestimated (Lemke and Poehling 2002).

6.4.3. Pollinators density and their landscape context

We found that higher grassland coverage in the landscape context reduced significantly the number of caught hoverflies, which is consistent with former studies (Haenke et al. 2009). Higher semi-natural landscape coverage and landscape heterogeneity are known to enhance hoverfly species richness (Hendrickx et al. 2007), even though their level of floral diversity needs to be considered as well (Kleijn and van Langevelde 2006). Furthermore, Meyer et al. (2009) showed that hoverfly species richness and activity-density were reversely influenced by the landscape context. While the diversity of floral resource drove the species richness, the availability of macrohabitats which are suitable to the

development of larvae drove their activity-density. This is relevant with our results, as the grassland coverage is inversely correlated with the cropland coverage of the 500 m landscape radius. Hence, we captured more hoverflies in fields surrounded by crops. This higher activity-density of hoverflies, observed in both grasslands and cereal fields, is usually due to the species guild whose larvae feed on annual crops aphids (Sadeghi and Gilbert 2000; Meyer et al. 2009). The same process can explain why we found less hoverflies in larger permanent grasslands. Indeed, one major guild is the one we referred to before, whose larvae feed on annual crop aphids; but the other major farmland guild's larvae are more related to woody habitats. Hence, grasslands do not support any of these important guilds. However, higher complexity is needed to enhance the pest predation by natural enemies, both at local and landscape levels (Chaplin-Kramer and Kremen 2012).

We observed the same negative impact of grassland landscape coverage on the number of sampled lacewings. Unfortunately, there is little literature about lacewings' response to landscape context. We can otherwise expect lacewings to respond quite similarly as hoverflies, since their resource need are close. Though the adult diet is polyphagous (McEwen et al. 2007), contrarily to hoverflies which feed exclusively feed on nectar juices and pollen. Then, like for hoverflies, more grasslands in the landscape meaning fewer crops, it is possible that we captured less individuals because of a lack of potential preys for the larvae.

6.4.4. Limits of the pollinators sampling

Although we observed significant variations due to landscape influence on hoverflies and lacewings activity-densities, we could see that the scope of this variation was quite narrow when we consider the number of individuals, only concerning less than 10 in the broader cases.

We designed our own flight trap, inspired by those usually used (Wilkening et al. 1981; Muirhead-Thompson 2012), though our human resource compelled us to open the traps at the same time as pitfall traps. This appeared to lower highly the efficiency of the trapping, since we did not synchronize our trapping periods to flowering periods, as it is generally the case for pollinator sampling (Gibson et al. 2011).

Moreover, we did not record the floral diversity of the grasslands. However, it is a major determinant of pollinators species richness and activity-density. Indeed, higher floral diversity and cover provide higher and continuous nectar and pollen food resource throughout the year (Branquart and Hemptinne 2000). Furthermore, hoverflies' activity-density is enhanced by higher floral diversity and cover, since their flight is highly energy-consuming (Haslett 1989; Haenke et al. 2009). Moreover, flower strips enhance both the species richness and activity-density of hoverflies, this effect is even

stronger in simple landscapes dominated by annual crops (Haenke et al. 2009). Another important point is the limit of studying the activity-density only. Indeed, in a recent review Dainese et al. (2019) showed that the impact of species richness was much more important than the one of activity-density on the effective pollination service which is delivered.

Since then, the observations we made can be biased. However, they were relevant with studies found in the literature. We thence suggest that our sticky flight trap may be of interest for measuring flying insect densities, and not richness since the individuals were rather damaged by the glue. Our sticky trap is though a good non-directional and non-attractive alternative, as the usual transect can be quite time-consuming. Nevertheless, to have a more precise sampling, there should be more traps per field, since we only put one of them, as well as a simultaneity of the sampling periods with important flowering periods. The latter condition may be the biggest mistake we have done, though it was restrained by our field manpower: we had to synchronize our pitfall and flight traps sampling periods.

6.5. Conclusion

Grasslands are highly important semi-natural areas for beneficial diversity in agricultural landscapes. For spiders, they are major drivers of family richness and density. Indeed, just like for carabids, they provide complementary resource and habitats to a broad diversity, thereby strengthening the landscape complementation hypothesis between crops and grasslands. However, we observed that grassland coverage in the landscape could have negative impacts on the hoverfly and lacewing densities, mostly because their larvae mainly feed in crops. The pollination service is though much more related to the species richness of the pollinators, than to their activity-density (Dainese et al. 2019). Finally, grasslands are important drivers of beneficial arthropod diversity in agricultural landscape, even though their effect needs to be complemented with other elements, to enhance the pollinators diversity, such as flower strips for instance.

7. General discussion

7.1 Main results and hypotheses validation

Beyond the field and farm system scales, the landscape level offers new perspectives for addressing the agroecological issues raised by intensive agriculture. The landscape scale indeed gives a global and spatial point of view and thereby is a relevant scale for both land planners and farmers to take action. We focused on the arthropod communities, mainly on carabids, from two farmland cover types: grasslands and cereal crops. The importance of the vicinity of grasslands, and more generally semi-natural habitats, has been shown to be important for enhancing biodiversity in croplands. Indeed, they provide resource complementation to the communities of croplands, which can spill-over into these more stable habitats in case of anthropogenic disturbance. Our work presents new insights by disentangling the influence of both field and landscape parameters on the arthropod communities from neighboring grasslands and cereal fields. We expected to find answers whether grasslands can support the conservation and enhancement of beneficial arthropod communities in crops. Furthermore, in order to assess a potentially shared carabid species richness between the two land cover types, we also studied their common species richness.

7.1.1 Neighboring grassland and cereal carabid communities have species in common

We sampled a total of 115 species overall, among which 82 in cereal crops and 95 in permanent grasslands. The mean per trap species richness per trap were equivalent for cereal crops and grasslands and around 7 species. We found that the carabid assemblages from the two land cover types were very distinct, being much more evenly distributed among the species in grasslands, whereas dominated by two ubiquitous species in cereal crops. Though, beyond these differences, we found that the species richness shared by the grasslands and cereal cropped fields was higher when the paired land parcels were neighboring than when more distant. This thereby confirms our *hypothesis 1*, according to which grasslands and cereal crops share carabid species, and that neighboring fields have more species in common than more distant ones. Though the carabid communities from both land cover types were richer in landscapes with higher configurational heterogeneity, our analyses showed that the grassland communities were enhanced by higher landscape diversity, but only in one study region. However, no landscape parameters significantly explained the species richness of carabids in cereal crops.

Moreover, we observed that the ratio of common species shared by both paired cereal and grassland land parcels was enhanced in landscapes with higher adjacency between these two peculiar land cover types. Our *hypothesis 3*, higher landscape heterogeneity fosters carabid richness no matter the land cover type, and *hypothesis 4*, semi-natural coverage around fields enhances carabid diversity in both land cover types, can be only partially confirmed. Only the carabids in grasslands were influenced by the landscape heterogeneity or the vicinity of other grasslands, though their effects were different according to the study region. Nonetheless, the overall carabid richness of both neighboring grassland and crop field was enhanced by higher configurational heterogeneity.

Our *hypothesis 5* stated that higher adjacency between cereal crops and grasslands would enhance the ratio of species common to these land cover types. It can be confirmed as we sampled more species common to both land cover types in landscapes with higher edge density between them.

7.1.2 Functional traits of carabids in grasslands and cereal crops

Focusing on the functional traits of carabids, we observed that polyphagous species were more likely to be sampled in both land cover types, whereas phytophagous ones were highly exclusive to grasslands and predatory ones to cereal fields. Small and apterous species were more sampled in grasslands only. Considering the influence of the landscape, we observed that polyphagous species were more present in cereal crops with higher grassland coverage in their vicinity.

Moreover, predatory species were more found in landscapes with higher configurational heterogeneity. Our *hypothesis 2*, suggesting that the carabid species common to both neighboring fields have generalist traits, is confirmed since we found more polyphagous species, more likely to be shared by the paired land parcels. We also confirm our *hypothesis 6*, according to which the species found in grasslands are more likely to be phytophagous and less mobile, while those in cereal fields are more predatory and mobile. *Hypothesis 7*, which stated that simplified landscapes filters mobile species is proven true. We indeed found that macropterous carabids, which are more mobile, were more likely to be found in low-heterogeneity landscapes.

7.1.3 Field and landscape parameters influence on other beneficial arthropods

Concerning spiders, our analyses showed that their family richness was not affected by landscape parameters, but only by the land cover type of the sampled parcel. We indeed observed higher richness in grasslands than in cereal crops. Their activity-density was nonetheless impacted both by field and landscape parameters, among which the grassland coverage was beneficial, while the compositional diversity of landscapes had no influence on grassland carabid communities, and a negative one on the cereal crop communities.

Our *hypothesis 8*, which expected higher spider richness in fields surrounded by higher semi-natural coverage and higher heterogeneity, is thereby mostly rejected. We captured more spiders in the vicinity of higher grassland coverage and thereby confirmed the importance of the vicinity of semi-natural habitats to enhance spider diversity through their abundance. However, the richness was not affected by the landscape context, though it is possible that the family richness may not be a sharp enough indicator, compared to species richness.

We sampled also lacewings and hoverflies in both cereal crops and grasslands. Their activity-density in cereal fields was lower in landscapes with higher grassland coverage. Therefore, our *hypothesis 9* is not confirmed, as it stated that more lacewings and hoverflies would be sampled in cereal fields surrounded by higher semi-natural coverage. Indeed, we observed a higher activity-density of lacewings and hoverflies in landscapes with higher annual crops coverage. However, the activity-density of hoverflies and lacewings may not be the appropriate indicator, since it is possible that we sampled fewer individuals, but higher species richness.

7.2 Managing the landscapes for beneficial diversity conservation

7.2.1 A mosaic of grasslands for enhanced potential biological control

7.2.1.1 Grasslands and annual crops can offer complementation

We observed that higher adjacency between grasslands and cereal crops involved a higher ratio of common species to these two land cover types. Moreover, these species were likely to be polyphagous, thus to potentially contribute to biological control. We sampled more spiders in both grasslands and cereal fields surrounded by higher grassland coverage. Grasslands indeed provide complementary resources and species communities to croplands (Roume 2011). Carabids and ground-dwelling spiders can overwinter in adjacent semi-natural habitats and colonize back the cropped fields as early as March in spring (Coombes and Sothertons 1986; Petersen 1999; Tscharntke et al. 2005b). Moreover, Labruyere et al. (2016) pointed out the positive effect of higher grassland coverage for polyphagous and phytophagous carabid diversity. This emphasizes that seed-eating carabids can find a continuity of foraging resource in neighboring grasslands when the cropped fields cannot sustain them anymore (Labruyere et al. 2018). Moreover, the presence of adjacent grassland facilitates the recolonization of cropped fields in the spring.

Though we did not find any consistent positive effect of the semi-natural coverage on the abundance of hoverflies and lacewings, we already tried to explain this unexpected observation. However, literature shows that hoverflies and lacewings need cropland to feed their larvae with aphids, though

the adults mostly feed on pollen and nectar in neighboring semi-natural habitats (Hickman and Wratten 1996; Long et al. 1998; Tscharrntke et al. 2005b). These are some practical examples of the usefulness of grasslands for beneficial insects in cropped landscapes. Likewise, the parasitoids of pollen beetle populations are enhanced by the vicinity of perennial habitat where the adults can forage, while the larvae are able to parasitize on their hosts in the crops (Thies and Tscharrntke 1999). A pan-European multi-taxa study, which included spiders and bees, showed that grasslands even more contribute to enhance local species richness if they are surrounded by higher non-cropped habitats, while cropland communities benefit from more adjacency with semi-natural areas (Concepción et al. 2012).

7.2.1.2 Enhancing the complementation towards beneficial arthropods

The heterogeneity at the landscape scale is more efficient to favor pest predation by natural enemies during the early season (Duelli and Obrist 2003b). It is indeed at this early period that the aphid predation is the most important to support better crop yields (Östman et al. 2001a). This points out that the provision of a pest control service mostly relies on a complex mosaic, where natural enemies can find resources all year through (Kleijn and van Langevelde 2006). For instance, ground-dwelling natural enemies, such as carabids and wolf spiders, can find high levels of forage resource in crops until their harvest. Since then, they need to disperse in adjacent fields, which can be either harvested as well, and are not fitted anymore, still cropped, or semi-natural areas (Thorbek and Bilde 2004; Tscharrntke et al. 2005b). Semi-natural coverage in the landscape thereby can offer alternative food resource, as well as overwintering and nesting habitats to a broad diversity of natural enemies, which will then be able to colonize back neighboring crop fields as soon as the early season comes (Nieto et al. 2006). Moreover, the preservation or restoration of semi-natural areas, such as grasslands, can increase more efficiently the diversity of pollinators than linear elements (Duelli and Obrist 2003b; Kleijn and van Langevelde 2006).

Though the carabid community from cereal crops were highly different from grasslands' ones, we observed a higher ratio of carabid species shared by neighboring grasslands and cereal crops, which can be explained by population movements between the two land parcels. The presence of grasslands in cropped mosaics, even if dispersed, can thereby provide a continuity of habitats and resources to natural enemies in case of disturbance in the cropped field (Schellhorn et al. 2014) as suggests the landscape complementation process (Dunning et al. 1992; Fahrig et al. 2011). Indeed, grasslands are known to be refuge habitats for natural enemies when the crops cannot sustain them, be they harvested or disturbed due to different farming activities (Schneider et al. 2013; Schneider et al. 2016). Otherwise, the carabid species shared by the neighboring grassland and crop might come from very distinct populations. Still, it is very unlikely that such mobile and generalist species do not move

between the land parcels to flee eventual disturbance from agricultural activities or to find continuous resource after the harvest.

Like other research works (Bretagnolle et al. 2012; Lindgren et al. 2018), we hence suggest the implementation of a mosaic of grasslands in farmed landscapes. According to the concept of conservation biological control (Fiedler et al. 2008), this is expected to enhance the overall beneficial entomofauna diversity as well as diversify the communities within the crops. Indeed, the generalization of grasslands in vicinity of crops could reinforce the resilience of agroecosystems by providing complementary resource and habitat to non-generalist or non-ubiquist species (Elmqvist et al. 2003; Bengtsson et al. 2003). We indeed observed that polyphagous, hence often generalist, were more likely to be sampled in homogeneous landscapes. Moreover, even when small and isolated, grasslands showed to contribute significantly to the enhancement of local species richness (Tscharrntke et al. 2002; Knapp and Řezáč 2015).

7.2.2 Taking natural enemies' dispersal ability into account

Even though both spiders and carabids responded positively to higher coverage of permanent grasslands in our study, other works made quite different observations (Elmqvist et al. 2003; Bengtsson et al. 2003). While spider richness and abundance seem to be generally enhanced by landscapes with higher coverage (Schmidt et al. 2008), only the carabid richness is increased by these parameters, though at a lower landscape scale (Gardiner et al. 2010). We found that macropterous carabids were indifferently caught in grasslands and in cereal crops, which emphasizes their mobility between the two neighboring land parcels. On the contrary, apterous carabids, which are less mobile, were much more affiliated to grasslands only.

Generally, carabids have lower dispersal abilities of carabids, even when compared to ground-dwelling spiders like wolf spiders. Indeed, some of these spiders are either pioneer species or can balloon, which enhances their dispersal ability. This dispersal is not comparable to ballooning spiders, like money spiders, which is much higher (Drapela et al. 2008). Species with lower dispersal ability are less competitive in case of local disturbance (Tscharrntke et al. 2005a): farming activities therefore select high-dispersal species. Moreover, the simpler the landscape, the less competitive are the low-dispersal species, which can eventually go extinct due to anthropogenic disturbance.

Schmidt et al. (2008) showed spider species with high dispersal abilities were more likely to be found in croplands, even though this habitat is not their most favorable one. Furthermore, the spider communities found in cereal crops are highly dominated by immigrant species coming from neighboring semi-natural habitats (Gavish-Regev et al. 2008). Indeed, we observed a higher spider

density in cropped fields in vicinity of higher grassland coverage. These observations emphasize the importance of the vicinity of both habitats in agricultural landscapes for enhancing potential biological control and natural enemy richness.

Moreover, due to the limits of dispersal abilities, larger fields are harder to colonize for natural enemies coming from adjacent semi-natural habitats, for both natural enemies (Woodcock et al. 2016). Thereby, besides the vicinity of grasslands, cropped fields natural enemy communities would be enhanced with higher configurational heterogeneity landscapes.

7.2.3 Small-scale and diversified farming as an opportunity for enhancing biological control

In this thesis, we observed that higher adjacency between crops and grasslands could enhance the ratio of species both found in these two land cover types. Moreover, our finding is that these species could be interesting to ensure potential biological control since they are likely to be polyphagous. Our results showed that higher landscape compositional heterogeneity fostered the carabid diversity of grasslands, while higher configurational heterogeneity was beneficial to the overall carabid richness from both paired land parcels. Besides, higher grassland coverage in near landscape was beneficial to the abundance of spiders.

Small-scale agricultural landscapes are known to enhance biodiversity, including carabids and spiders (Fahrig et al. 2015; Petit et al. 2017; Gallé et al. 2018b). Indeed, smaller fields ease the colonization from adjacent land parcels by natural enemies (Merckx et al. 2009). Higher edge density can have positive effects on biodiversity as well; as we ourselves observed. In this case, the mobility between the different land parcels is eased for the natural enemies, as they have more boundaries to cross between different habitats and find either complementary resource or refuge habitats when needed (Bianchi et al. 2006; Gallé et al. 2018a).

We found landscape compositional diversity to enhance carabid richness, except in Forez, where the grasslands occupied larger areas in the landscape. In our case, compositional diversity was closely related to crop diversity. Indeed, carabid communities can take advantage of a broader variety of crops, since they can move between the fields in case of disturbance or harvest and then find a continuity of resource through landscape complementation and spill-over (Sirami et al. 2019).

Our results hence suggest to enhance potential biological control through the richness and the abundance of natural enemies. Indeed, a mosaic of grasslands, small-scale farming as well as higher crop diversity are all measures which focus on the provision of complementary habitats and resource

to natural enemies (Gontijo 2019). We hereby prioritized the integration of ecological processes and ecosystem services in the implementation of agroecological practices as fundamental bricks of agroecosystems instead of conventional practices and solutions (Wezel et al. 2014). The integration of agroecology at the landscape level indeed can help agriculture to finally integrate biodiversity, hence enhancing it, instead of threatening it (Perfecto et al. 2010).

7.2.4 Complementary landscape solutions

The implementation of grasslands can nonetheless have drawbacks, by enhancing the crop seed predation, especially by vertebrates, while reducing the predation of pests by intraguild interference between natural enemies (Tschumi et al. 2018). However, the enhancement of natural enemy diversity has been proven to be efficient to reduce the populations of pests, intraguild interference could be observed (Straub et al. 2008; Holland et al. 2012).

We did not find any influence of the landscape context on the carabid richness in cereal fields, in contrast to other previous studies (Fahrig et al. 2011; Fahrig et al. 2015; Madeira et al. 2016). Nevertheless, carabid richness in grasslands was higher when surrounded by more heterogeneous landscapes, except in the study region which was dominated by grasslands. Furthermore, we found configurational heterogeneity, through the parameter of edge density, to foster the overall carabid species richness of neighboring grasslands and cereal crops.

Indeed, more heterogeneous agricultural landscapes are indeed known to foster biodiversity, even at multi-trophic levels (Fahrig et al. 2015; Gallé et al. 2018a; Sirami et al. 2019). This involves a more diverse crop mosaic as well as smaller fields. Moreover, higher crop diversity provides communities a wider resource availability and diversity, which consequently fosters biodiversity (Wiens et al. 1993; Wiens 2002; Mouquet and Loreau 2002). Crop diversity also contributes to provide continuous resource to natural enemies, since they can move from one field to another when winter crops are harvested close to spring crops, according to the landscape complementation process. Smaller fields ease colonization of natural enemies from adjacent fields and grasslands, since the distance individuals must cover is lower to get to the field core (Woodcock et al. 2016). Thereby, biological control is ensured by natural enemy coming back from adjacent fields on the whole surface of the field.

Even though we did not find any significant effects of semi-natural linear elements, except to enhance the number of captured lacewings in grasslands, many previous studies emphasize their role for functional biodiversity. Linear elements can as well be of interest to enhance biological control. Vegetation strips (Rouabah 2015) and hedgerows (Garratt et al. 2017; Pecheur et al. 2020) can foster the diversity and abundance of natural enemies in neighboring crops, even more when they belong to

a coherent ecological network. Like grasslands, linear elements at field margins can provide complementary resources, either habitat or food, to natural enemies coming from croplands. The floral diversity found in such margins also favors hoverflies and lacewings, whose adults are pollinators, while the larvae feed on aphids (Ramsden et al. 2015). Schirmel et al. (2016) observed functional differences between the spider and predatory carabid communities from woody and herbaceous linear elements in agricultural landscapes. Indeed, in the woody communities these arthropods had lower dispersal abilities and higher foraging specialization, while communities in herbaceous strips were more generalist. However, the communities in woody elements were also much more sensitive to fragmentation between woody elements, while communities of carabids and spiders in herbaceous strips were only enhanced by landscape compositional diversity and local plant richness.

7.3 Higher biodiversity may favor potential biological control

7.3.1 Complementarity of natural enemies as an asset for biological control

This thesis aimed at finding which field and landscape parameters could enhance natural enemies' richness and abundance in cereal crops and grasslands. We observed that, overall, grassland carabid communities were more compositionally diverse than croplands, where a few generalist species occupied almost 70% of the sampled individuals. However, we mainly focused on the species richness of carabids, since this family provides both pest and weed control which are important ecosystem services for agriculture.

Higher richness indeed enhances the provision of ecosystem services, both biological control and pollination (Dainese et al. 2019). Both the species richness and the abundance of the service providers have positive impact on the service itself, even though the direct impact of the species richness is more important. A broader diversity of natural enemies enhances the efficiency of pest predation (Thies et al. 2011; Dainese et al. 2017b). Indeed, the pest predation rate is higher due to the combined pressures applied by different kinds of predation. For instance, cursorial hunt, web-trapping or parasitism put a diversity of pressure on pests. The same can be said about the location of the pest control: in the canopy in the example of parasitoids or web our vegetation-dwelling spiders, on the soil for ground-dwelling predators like wolf spiders or carabids. Moreover, aphid predation rates has been proven more efficient with multiple predation styles, which shows a synergistic effect between the natural enemies when they are more diverse (Schmidt et al. 2003). This kind of synergy between predators foraging in different vegetation stages has been described by Losey and Denno (1998). They observed that the predation rates of two natural enemies, one foliar-dwelling ladybug and one ground-dwelling

carabid, was more than twice their summed individual aphid predation rates when observed together in field. These observations emphasize a synergy among natural enemies when they are more diverse, which then enhances their pest control (Figure 35).

Moreover, this kind of complementarity is thereby observable among spider families. Coherently with previous studies (Sunderland et al. 1986; Ekschmitt et al. 1997; Schmidt et al. 2003; Moonen and Bàrberi 2008), we mainly captured wolf spiders and money spiders, which altogether represented 81% of the total sampled individuals. These two families do not have the same predatory diet: while wolf spiders are ground-dwelling generalist (Nyffeler and Sunderland 2003), money spiders are web-builders and stay in the crop canopy, where they feed for the most on aphids (Sunderland and Samu 2000).

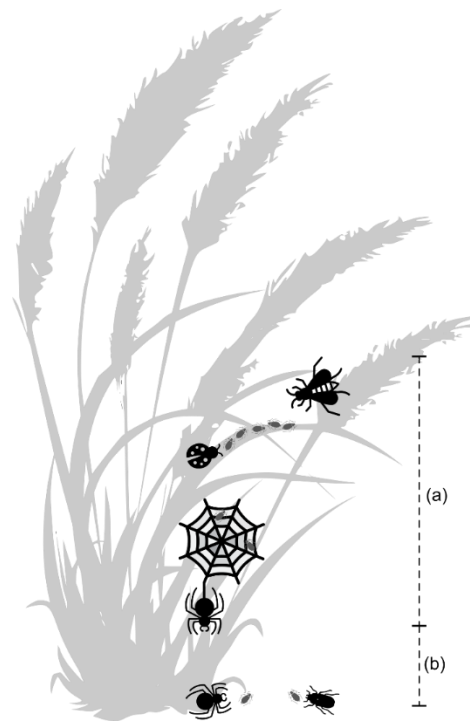

Figure 35. Illustration of aphid predation complementarity between (a) the vegetational stage, with foliar dwellers, parasitoids and web spiders; and (b) the ground stage with ground dwellers.

Among carabids, complementarity can be observed as well, although they all are ground-dwellers. For instance, Oberholzer and Frank (2003) observed that different carabid species could more efficiently reduce the populations of slugs in croplands by preying on various biological stages. While some would rather forage on the eggs, other focused on young individuals. Moreover, the prey spectrum of such species can vary, even between generalist predators. Thereby, higher carabid diversity helps to cover more potential preys by resource partitioning (Tscharrntke et al. 2005a). Moreover, besides pressuring the pest populations at different development stages, higher natural enemy diversity can also have

complementary predation periods across time, and thereby apply a continuous pest control. Indeed, while carabids are the most effective at controlling aphids during the early season, their combined action with spiders is more efficient in mid-season (Lang 2003).

7.3.2 Higher diversity involves higher resilience of the enemy community

Furthermore, higher diversity among natural enemies may allow higher resilience of the whole community in case of disturbance. Every species may display a different level of tolerance towards various kinds of disturbance that farming activities can involve (Elmqvist et al. 2003). This is referred to as the insurance hypothesis: higher natural enemy diversity gives their community, hence the biological control they provide, a higher stability towards disturbance (Loreau et al. 2003; Tscharrntke et al. 2005b). Insurance is provided by higher biodiversity only if refuge habitats are at a dispersal distance from the field. Indeed, it is the species general ability to elude the disturbance, hence to disperse, which appeared to be prior in the resilience of the ecosystem productivity (Loreau et al. 2003). Thereby, the spatial character of the insurance hypothesis is essential, and it relies on both crop diversity and the vicinity of semi-natural fields such as grasslands.

The insurance hypothesis echoes the concept of conservation biological control (Tscharrntke et al. 2007), which states that natural enemies diversity is higher in croplands when in vicinity of non-cropped areas. In order to preserve the natural enemy which are already present in the landscape, the conservation biological control approach suggest preserving or restoring perennial habitats such as semi-natural ones. They indeed can provide to natural enemies overwintering and nesting sites, refuges in case of disturbance as well as complementary food resource (Landis et al. 2000; Bianchi et al. 2006). In order to provide these resources even to natural enemies with small dispersal abilities, non-cropped areas are thereby needed directly or closely next to the crops (Tscharrntke et al. 2007).

7.3.3 Limits to enhancing natural enemy diversity

7.3.3.1 Composition rather than diversity?

In our study, polyphagous carabids, hence generalist, were mostly sampled in cereal crops. Moreover, polyphagous carabids were more likely to be caught in cereal fields in vicinity of grasslands; they were also more likely to be shared by both paired land parcels. This gives indication that they can find resource complementation in grasslands and cereal crops and thereby move between these two land cover types.

Some studies have proven that pest populations are significantly controlled by generalist predators which could switch to other non-pest preys and have higher generation times before having any

significant impact on the pest population (Symondson et al. 2002), while other research works point out to the need for both generalist and prey-specific natural enemies to improve the efficiency of biological control (Alhadidi et al. 2018). It would then rather be the composition, and not the diversity, of natural enemy community which would be decisive for biological control.

More generally, parasitoids are generally natural enemies specialized in the parasitism of a given pest host. This key-characteristic makes them very efficient biological control agents, while ground-dwellers are generalist which can prey upon a broad spectrum of pests (Snyder and Ives 2003; Ives et al. 2005; Tscharrntke et al. 2005b). Furthermore, generalist predators may lack efficiency in case of pest overcrowding.

Thereby, the polyphagy of some abundant species can sometimes complicate the interpretation for biological control, since they can switch to alternative preys and not only forage on pests (Prasad and Snyder 2006). The generalist predatory communities of spiders and carabids have been proved to reduce significantly aphid populations, even more when the two groups are acting together (Symondson et al. 2002; Lang 2003). On the spider side this may be mostly due to money spiders, more than wolf spiders, as their web trap predation method is complementary to ground-dwelling and cursorial hunting carabids. Carabids and money spiders can hence control the pests both in the canopy as well as on the ground.

7.3.3.2 Intraguild interference between natural enemies

Pest control by natural enemies can be mitigated by intraguild predation between natural enemies themselves. Therefore, it is possible that higher natural enemy diversity does not enhance their overall predation rate, being in competition for the same resource or even feeding on each other (Holt and Polis 1997; Ives et al. 2005). Indeed, natural enemies of higher trophic level can potentially forage on other ones, hence limiting their overall benefits for farming activities.

Prasad and Snyder (2006) for instance showed that the presence of *P. melanarius*, which represented 3% of our samples, mainly in cereal crops, can have negative impacts on the predation rate of pests. This peculiar species occasionally feed on smaller carabids, though they are efficient pest predators (Prasad and Snyder 2004). Moreover, *P. melanarius*, and other carabid species to a lesser extent, can also prey on wolf spiders, and thereby have another intraguild interference (Lang 2003). *P. melanarius* has been observed to significantly reduce the parasitism rate of aphids under experimental conditions by Snyder and Ives (2001) by preying on *Aphidius ervi*, a parasitoid wasp. Though carabids can efficiently control the populations of aphids at early growing stages of the crop, they are no more efficient when the crop is higher, with aphids adopting antipredation behaviors. *P. melanarius* thereby switches to alternative preys, among which the vulnerable parasitoid pupae.

We caught numerous spiders in our pitfall traps, with an average of 49 individuals per trap whereas we captured an average of 27 carabids per trap. Nonetheless, spiders can be predatory to other spider species (Wise 1995; Hodge 1999; Denno et al. 2004; Finke and Denno 2004). This intraguild predation can diminish their potential for pest control. However, spiders rarely feed on other predatory arthropods, which enhances their appropriateness for biological control (Nyffeler and Sunderland 2003). Therefore, intraguild predation can raise serious biological control issues when a specialized natural enemy, such as a parasitoid is preyed upon by a generalist predator (Snyder and Ives 2001; Ives et al. 2005; Gontijo et al. 2015).

Furthermore, higher landscape heterogeneity reduces the importance of this intraguild predation between natural enemies (Finke and Denno 2002). Indeed, the diversity of habitats found in such landscapes allows potential intraguild preys to find refuge from their predators, which thereby reduces the negative influence of intraguild interference on the predation rate of pests. On the contrary, the density of pests is usually lower with higher non-crop habitat coverage in vicinity of farmed fields (Dainese et al. 2017b), mostly due to a more efficient top-down control by natural enemies.

Finally, there is evidence that the intraguild interference between natural enemies can have variable effects on pest control (Tscharrntke et al. 2005a). It can therefore be rather difficult to assess and theorize globally, depending on a broad variety of factors among which the intraguild and pest communities, the kind of crop, abiotic factors and even anthropic field management (Lucas 2013). However, field studies, rather than laboratory experiment, suggest that intraguild interference is low and higher natural enemy richness favors higher pest control (Straub et al. 2008; Holland et al. 2012).

7.4 Operational recommendations, tools and public policy

7.4.1 Public policies of landscape management

This thesis also aims at emphasizing concrete solutions for both land planners and farmers, in the framework of the SRCE framework in the Rhône-Alpes region. The consideration of grasslands for biodiversity is important in Agri-Environment Schemes (AES) since they are levers for action. Permanent grasslands still represent 33 % of the utilized agricultural land of the European Union (Peyraud et al. 2012) and they are productive lands for farmers. Therefore, they need to be considered as essential parts of farmed landscape (Bretagnolle et al. 2012).

The AES are the European Union tools, through the Common Agricultural Policy, to counter or lower the negative impacts of intensive agriculture on biodiversity (Arponen et al. 2013; Ekroos et al. 2014).

In a study concerning six European countries, Kleijn and Sutherland (2003) showed that 54 % of AES had a positive effect on one species at least, while 6 % presented a negative effect. The simplification of landscapes is a major reason for this relative failure, since the reduction of semi-natural coverage reduces the efficiency of environmental schemes.

More generally, Emmerson et al. (2016) recommend the extension of AES to the landscape level, so they include multiple farms and fields. They suggest it would improve the efficiency of AES in the enhancement of biodiversity. Indeed, they observed an inconsistency of some response of biodiversity and the ecosystem services it provides; they explicitly relate this issue to the lack of coordination among farmers and landowners concerning agricultural practices and land use.

In order to take into consideration the services that biodiversity can provide to agriculture, Ekroos et al. (2014) suggest two new kinds of AES in the CAP, which would target different species and express the best of farmlands potential for biodiversity (Altieri 1999). The first kind of scheme would then target all conservation purposes, biodiversity in general, whereas the second kind of scheme would focus on the biodiversity providing ecosystem services to agriculture. Ekroos et al. (2014) thereby suggest that this distinction could help to enhance the beneficial diversity, since these species would benefit from both conservation and ecosystem services schemes. Nonetheless, the authors admit that their proposition fails to consider the organization of agricultural landscapes, although the interaction of AES with landscape context, and its impact on biodiversity, have been assessed (Batáry et al. 2011; Tschardt et al. 2012b).

There, the work of Arponen et al. (2013) is of interest, since they accounted for the implementation of landscape organization into AES. More precisely, they focused on grasslands and their connectivity. They indeed showed that the efficiency of AES highly depends on the connectivity with other neighboring grasslands. The authors thus conclude that the AES should be adapted to the local context in which they are to be applied, which points out the difficulty to generalize the efficiency of a given AES measure.

In Rovaltain, and in Bièvre to a lesser extent, there is a strong need for restoring and preserving permanent grasslands. Indeed, Rovaltain farmlands are highly dominated by annual crops while grasslands only cover 3% of the whole study region, concentrated on the foothill. Thus, we suggest the application of an AES which would favor the restoration or preservation in the agricultural plain, since it can be economically difficult for farmers to support this endeavor on their own. This recommendation would be also useful in the northern part of Forez, dominated by temporary grasslands. In all three study regions, there would be a need for enhancing crop diversity, for instance with legumes. We then suggest an AES for subsidizing the farmers with a broader variety of crops.

Moreover, local authorities could support the economic valorization of legume productions locally, through collective catering for instance. Another idea would be to aid the implementation of four-year temporary grasslands, which can help providing temporarily stable habitats in cropped landscapes.

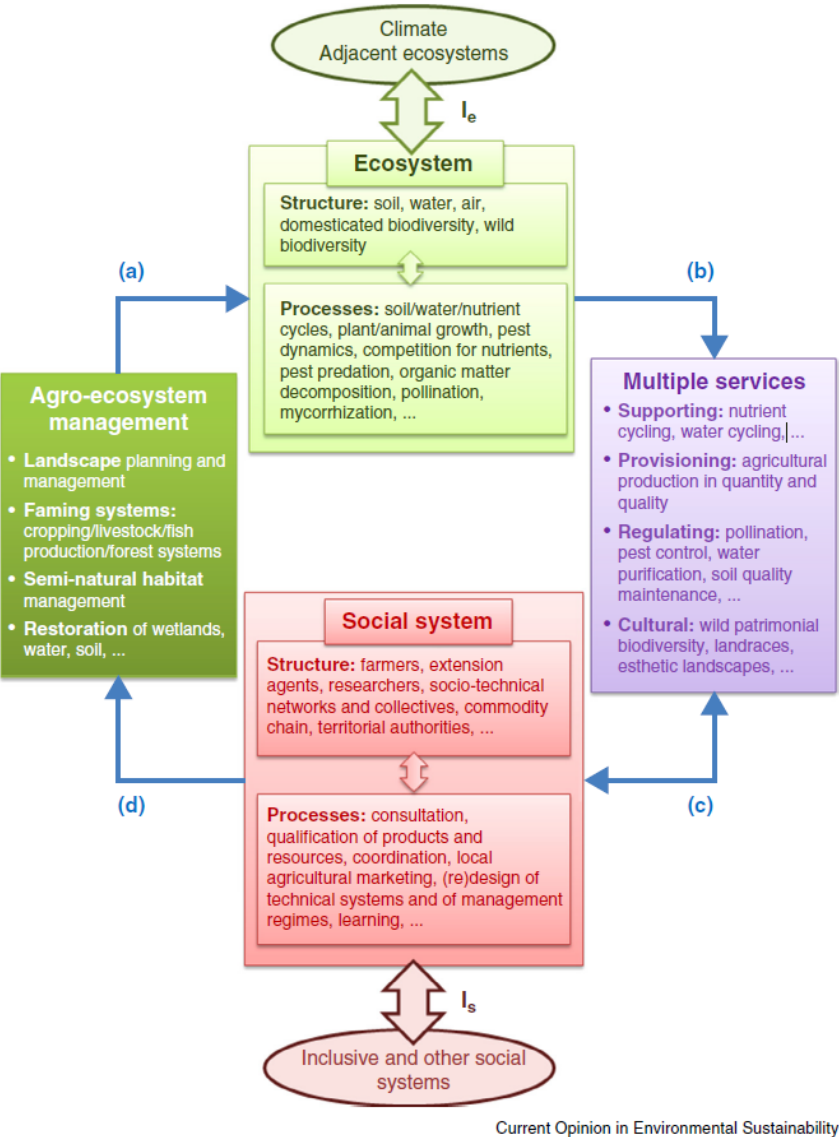

Figure 36. Social-ecological framework adapted to the management of agricultural landscapes and the provision of ecosystem services (Source: Lescourret et al., 2015)

Finally, Lescourret et al. (2015) suggest a brand-new approach to involve locally all the concerned actors, from the land planners to the farmers. This work points out that agricultural landscapes were mainly managed by farmers. Even though the ecosystem services benefit highly to food production (Power 2010), they would favor a broad diversity of stakeholders as well. Then, this social-ecological framework addresses the management of ecosystem services provision in agricultural landscapes (Figure 36). One prior point of this framework is to give equal importance to both social and ecological

systems (SES), which had been failed by previous social-ecological frameworks (Binder et al. 2013). Furthermore, one strength of this conceptual framework is to be adaptable to different scales, from local agricultural regions to European Union, for instance. Then, higher scale SES include multiple embedded smaller scale SES. Whereas the efficiency of collective management has been proven when the aim is precisely targeted (Brewer and Goodell 2011; Fischer and Charnley 2012), few successful examples have arisen for multiple services provided by landscapes. As the achievement of agroecological goals and the enhancement of ecosystem services would have beneficial synergistic effects, there is a strong need for appropriate collective management between farmers and other stakeholders from agricultural landscapes.

The establishment of such collective management between local authorities and farmers would aim at favoring concerted decision-making. Then, for instance, we suggest the execution of an ecological reparcelling, which would collectively shape the landscape. There have been multiple reparcelling since the 1950's, though the latter aimed at easing the mechanization and intensification of agriculture. This new kind of reparcelling would aim at fitting the landscape to agroecological purposes, both at the landscape and practices level. The plantation of hedgerows or other implementation of herbaceous vegetation strips in order to bring back linear semi-natural elements as well as reducing the field size or the insertion of grasslands within cropped mosaic are examples of what could be implemented with this ecological reparcelling.

7.4.2 At the farmers' level

Until a collective management of agricultural landscapes is established, farmers remain prior actors to enhance ecosystem services at the landscape level. We observed that most explanatory landscape scale for explaining carabid species richness and species traits were the smallest we analyzed, 200 m. Indeed, explanatory landscape scales for biodiversity can be rather small, therefore some decisions can be made by farmers, both individually or collectively (Weibull et al. 2003).

At the level of their individual farm, farmers can act on both farming practices and landscape organization. We have already set some recommendations about landscape management, among which the most important one is the preservation or restoration of a mosaic of grasslands within the farmland mosaic. Though we are conscious this suggestion cannot rely on the farmers' shoulders only, we also know that they are currently the major direct vector for such a measure. Therefore, we know that the individual initiative can only be partially a way to preserve or restore a grassland mosaic. Then, individual farmers could hardly make significant changes at the landscape level unless if they are

supported by appropriate public policies. Nonetheless, farmers can make significant changes at the practices level.

The change of farming practices in order to enhance biological control are not the main subject of this thesis; however, there are some that can be of interest to enhance biological control (Rosa-Schleich et al. 2019). First the diversification of the crops, in case the farmer can significantly impact on the local landscape compositional heterogeneity with his fields only. Second, the diversification of rotation benefits the farmer ecologically as well as economically, since it increases it can help reducing the input and the pest and weed risk at long term (Wezel et al. 2014). Indeed, longer and more diversified rotations also can help to enhance the crop diversity in the landscape, which is beneficial to natural enemies. Cover crops and green manure are interesting to foster the fertility of cropped fields while reducing the consumption of artificial inputs. Moreover, cover crops can contribute to the continuity of food and habitat resource which beneficial entomofauna may need (Dabney et al. 2001). Reduced tillage, or no-till can have advantages for natural enemies, since a lot of them can be killed in the process. Thereby, the reduction of this disturbance can be of great interest to favor biological control, particularly by ground-dwellers or species overwintering underground.

As it combines all the previous practices, conservation agriculture is highly interesting to enhance potential biological control. Indeed, conservation agriculture involves high diversity in the crop rotation, cover crops and reduced tillage or even no-till. Indeed, conservation agriculture seem to be an interesting alternative to the conventional one, as it balances the productivity and ecological performances (Chabert and Sarthou 2020).

Concerning grasslands, the mowing can be done when it is interesting to force the emigration of carabids and spiders into neighboring cropped fields (Ekschmitt et al. 1997). Finally, the adoption of organic practices by some farmers can benefit the whole landscape. Indeed, organic farming is thought to enhance by 30% the species richness of agroecosystems (Bengtsson et al. 2005; Tuck et al. 2014). Moreover, organic fields with conventionally farmed mosaic can be refuge areas for species from conventionally managed fields (Schmidt et al. 2005a; Djoudi et al. 2019). More generally, organic agriculture can help the preservation and the restoration of ecosystem services in farmland, and even benefit of conventional farmers in their neighborhood (Sandhu et al. 2010).

7.4.3 Applied recommendations for our study regions

In this, part, we will focus on two of our study regions, each representing a typical case of agricultural landscape. First is Rovaltain, with permanent grasslands only occupy 3% of the whole study region and are rather concentrated on the foothills. Arable lands occupy 48% of the entire region. Moreover,

Rovaltain is the study region where we found both the lowest carabid richness and abundance per trap. As we have raised it before in the general discussion, Rovaltain would highly gain from restoring a grassland mosaic. Permanent grasslands would thereby bring some stable open land covers in the mosaic, providing a continuity of resource to cropland biodiversity. Even 4 years temporary grasslands in the rotations could be favorable to natural enemies, as they are relatively stable and less disturbed than crops.

To achieve this objective, local authorities and professional agricultural organizations, such as chambers of agriculture, could help the farmers by facilitating their meeting. The aim of these meetings would be to set a collective landscape management, by pointing the fields that could be turned into permanent grasslands, making sure that they form a consistent mosaic. In this case, consistency means that they are as much as possible equally accessible from neighboring cropped fields. Moreover, in these assemblies, farmers and authorities could decide together on how to compensate for the fields turned into grasslands, since this concession from some farmers is beneficial to the entire community.

Second study region is Forez, where the permanent grasslands are important, occupying 27% of the whole study region. Moreover, in Forez, the temporary grasslands are well included in the crop rotations, which is due to the importance of the livestock breeding activity. Hence, the Forez is the region where we found the highest general species richness of carabids, with 61 different species in cereal crops, 70 in grasslands and 90 overall. Our landscape recommendation would be to favor the implementation of permanent grasslands in the northern part of the study region. They are indeed rare in this area, though temporary grasslands are well integrated in crop rotations. The main problem in Forez is more economic than agroecological, even though progress could always be made by scaling down and diversifying a bit more the landscapes. Indeed, the economic sustainability of livestock breeding is threatened, especially for dairy farmers. The selling price of raw milk appears to be insufficient to maintain this activity in farms; during this thesis work some farmers we worked with abandoned dairy activity specifically for this reason. There is here a stake to seize for local authorities and chamber of agriculture, either to build local economic opportunities for raw milk, such as the valorization of their well-known cheese, the *Fourme de Montbrison*. Another opportunity would be to help the farmers into converting to organic farming, since the economic valorization of this agriculture has protected them from market fluctuations hitherto.

7.4.4 Agricultural landscapes as a Common

Intensive agriculture raises issues of concern about biodiversity, thereby the ecosystem services it provides and threatening its own sustainability. In the case of agricultural landscapes, Bretagnolle et

al. (2012) suggest the collective consideration of grasslands in landscapes by farmers; beyond the individual logic which currently dominates the management of landscapes through individual private property. This idea of collective decision to design and manage agricultural landscapes has also been raised by other research works (Lescourret et al. 2015; Dumat et al. 2018) and therefore takes an important place in the recommendations we formulated.

In fact, Leopold (2014) already pointed out the need for an understanding of the concept of land as a community. By stating that the land is a community, he meant that human beings, and their societies need to insert themselves and their activities into the whole ecological community to which they inherently belong. He opposed to the view of land as “commodity”, mostly driven by the utilitarian philosophy. Leopold (2014) tried to warn that the growing power of humanity, gained through industrialization which by then was attaining agriculture, would eventually provoke unprecedented damages to ecosystems.

Indeed, Moore (2017) argues that the human organizations and activities cannot be thought abstracted from ecological cycles. He came to that conclusion while studying the historical and economic contexts in which the current ecological crisis rose. Moreover, Moore raises the notion of Capitalocene, since he explains that capitalism is responsible for the ecological crisis. According to Moore, constant and infinite capital growth relies on Cheap Nature, meaning cheap natural resource. Hence, capitalism, the current development and economic system cannot sustain itself and raises major social-ecological issues (Moore 2017; Moore 2018).

In order to overcome the current ecological crisis, we need to find new ways to organize humans and their economic activities. In the case of agricultural landscapes, we have already suggested to innovate with governance systems which would involve local communities in the decision-making process. An interesting global framework which could help to overcome the allow the consideration of the whole agricultural landscape is the one suggested by Ostrom (2015). Indeed, a Common can be defined as any resource potentially shared by a community, which is subtractable, i.e. its consumption by a person reduces others' consumption, and whose boundaries can be difficult to define (Ostrom and Hess 2007). Inspired by a variety of concrete situations throughout the world, Ostrom (2015) then suggests an institutional framework in which local communities could collectively manage their common pool of resource (Figure 37).

1. Define clear community boundaries.
2. Match rules governing the use of Commons to local needs and conditions.
3. Ensure that those affected by the rules can participate in modifying the rules.
4. Make sure the rule-making rights of community members are respected by outside authorities
5. Develop a system carried out by community members, for monitoring members' behavior.
6. Use graduated sanctions for rule violators.
7. Provide accessible, low-cost means for dispute resolution.
8. Build responsibility for governing the Common in nested tiers from the lowest level up to entire interconnected system.

Figure 37. Elinor Ostrom's eight principles for governing the Commons (Ostrom 2015).

The Commons thereby interrogates a whole side of our social organization, which we call capitalism, based on private and lucrative property as well as the maximization of economic liberty (Friedman 1963). Capitalism relies on the perpetual accumulation of capital, which involves continuous and infinite growth (Giraud and Renouard 2015). Therefore, the (re-)establishment of Commons in our society would be an important shift in our ideological relationship to the world. Moreover, Ostrom's institutionalism does not question private property nor capitalism for itself, though it suggests an alternative way to manage resources when both private and public property fail (Ostrom 2012).

As the use of landscape by some excludes that of others, and since landscapes cannot always be defined precisely as a resource, landscapes correspond to the definition of a Common (Ostrom and Hess 2007). Indeed, the idea of landscape as a common has been developed (Pittaluga 2013). For instance, the *Cinque Terre* region of Italy established a local collective authority whose aim was to fight against the ecological and economic crises which were depleting the region. The consideration of landscape as a Common helped diversifying the agricultural productions and created many jobs, mostly in agriculture and tourism. Another example quoted by Pittaluga (2013) is the experiment around the international network of Model Forest. Model Forests' goal is to favor ecologically heterogeneous and biodiversity-friendly forests through diverse forms of management. This network involves local communities in the definition of their economic and ecological objectives through a participatory and inclusive process. Other than the protection of biodiversity, economic activities such as farming and their sustainability are central in the definition of the collective project.

These examples show that considering landscape as a Common to shape a collectively defined socio-ecological project, economically sustainable, has been experienced elsewhere. However, the institutionalism of Common by Ostrom (2015) does not provide any magic bullet, as it recognizes that every community has its own perceptions, rules, conditions and traditions. Then, on the basis of this

conceptual framework, it may be possible to experiment the institution of agricultural landscapes as a Common and thereby conciliate agricultural activities and the preservation of biodiversity through collective locally-based decision-making.

7.5 Limits of the thesis

7.5.1 Some issues regarding our data collection and sampling

The first problem we met with our sampling protocol concerned the grazed grasslands in which we sampled. Indeed, it has been difficult for us to keep on sampling in this kind of grasslands since the cattle systematically destroyed the traps, especially the flight traps, though the pitfalls were also often? trampled. Therefore, we decided not to continue in sampling in grazed grassland after first experiences. We then captured only in mown grasslands, though we did not remove from our results database the few traps we already surveyed in pastures (6 grazed out of 102 grasslands sampled overall). There can be a small bias in our sampling, since we should have focused only on mown grasslands at the beginning of the study, in order to at least set this management parameter for grasslands.

The second issue concerning our sampling is the design of the flight traps. However, we already discussed this matter the previous result chapter. The fact that our flight traps were sticky prevented any possibility to identify the samples to the species level. This appeared to lead to an analysis of moderate interest, since we could only draw conclusions about the density of our samples.

7.5.2 Differences between study regions

We sampled in three different study regions in order to check the consistency of the biodiversity responses to field and landscape parameters. We proceeded that way in order to compare these parameters on the beneficial entomofauna of three different coverage ratios between annual crops and permanent grasslands.

Concerning the field parameters, the consistency of the answers was not so high when it was significant. Moreover, the answers of carabid richness or spider density were much more variable from one study region to another. Although these observations highlight some interesting points about difference of landscape influence on biodiversity under different pedo-climatic and historical conditions, they also show how difficult can be the observation of ecological communities in multiple regions. Moreover, this variation in results also shows the limits of studying given parameters while

other uncontrolled parameters, such as ecological history, soil or climate conditions, can also significantly affect the observed variable.

7.5.3 Landscape-practices interactions towards biodiversity

Though we did not study the impact of the agricultural practices on beneficial entomofauna, we had to face this question when we observed no significant influence of the landscape context on carabid communities in cereal crops. Both levels are indeed necessary to enhance biodiversity. Petit et al. (2017) for instance showed that weed seed predation by carabids was enhanced both by higher compositional heterogeneity and conservation agriculture practices. The positive effect of landscape composition is however lower in fields which have been under conservation practices for more than four years.

However, both the intensification level of practices and landscape are known to have combined negative effects on the biodiversity (Figure 38), at every level of the trophic web (Batáry et al. 2017). Indeed, more complex landscapes offer a wider diversity of ecotones and habitats to biodiversity, hence host a broader diversity of species than more simple landscapes, typical of intensive agriculture. Though, within these landscapes, organic practices favor higher species diversity than conventional farming (Bengtsson et al. 2005; Geiger et al. 2010; Batáry et al. 2017).

There is then substantial evidence that the effect of farming practices interacts with the influence of landscape context, i.e. heterogeneity (Figure 38). Organic farming is more beneficial to the diversity of multiple taxa in homogeneous landscapes (Rundlöf et al. 2008; Smith et al. 2010; Tuck et al. 2014). Nonetheless, though organic farming is sensibly more beneficial to biodiversity, Batáry et al. (2017) showed that small-scale conventional management supports higher diversity of plants and arthropods than large-scale organic farming. Even though both landscape and farming intensity parameters have significant effects on the determination of the biodiversity, Batáry et al. (2017) showed that the landscape effect comes in first. Future research works need to consider both landscape and farming practices (Karp et al. 2018).

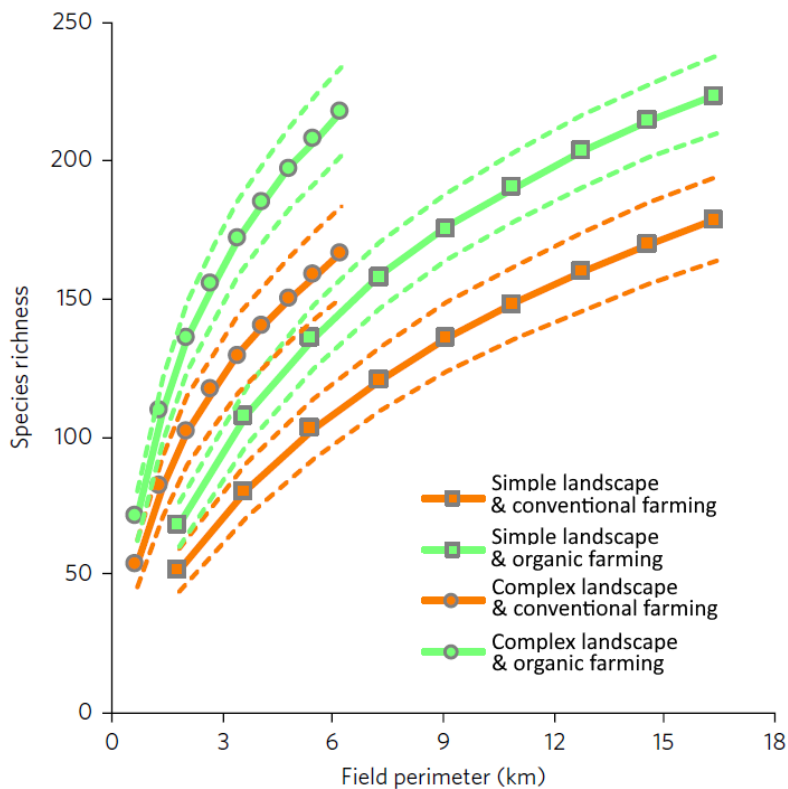

Figure 38. Combined effects of landscape heterogeneity and farming practices on biodiversity
(Source: Batáry et al., 2017)

These interactions between farming practices and landscape heterogeneity can be explained in many ways. Firstly, it is possible that organic farming helps maintaining or restoring habitat diversity in homogenized landscapes (Rundlöf and Smith 2006), thus making the whole landscape more suitable for higher diversity (Benton et al. 2003). Secondly, since organic farming increases the spatiotemporal heterogeneity of the landscape (Danhardt et al. 2010), we would expect the impact of organic practices to be more important in homogenized landscapes. Thirdly, the difference between conventional and organic practices may be more important in simple landscapes. In more homogeneous landscapes dominated by crops, organic fields can thereby provide refuge habitats and compensate to some extent the lack of semi-natural areas (Pfiffner and Luka 2003).

The simplification of the landscape and intensive agricultural practices also impact on the plant diversity. Yet, more diverse plant community enhances overall diversity and benefits agroecosystems (Letourneau et al. 2011) as well as faunal diversity (Pfiffner and Luka 2003; Plantureux et al. 2012). This relation is so strong that some authors even defined habitat as native vegetation (Andren 1994). However, mineral fertilization tends to homogenize the plant community towards opportunistic nitrophilous species, mainly weeds, even in the field margins (Solé-Senan et al. 2014). Moreover, there is a loss plant diversity in field edges and hedgerows due to the drift and leaking of herbicides between

4 and 10 meters beyond the crops boundaries (Stoate et al. 2001; Gove et al. 2007). In landscapes where semi-natural habitats are scarce and/or small, i.e. whose area is on average inferior to 2 ha, this homogenizing effect affects more than 20 % of their land cover (Boutin and Jobin 1998).

8. Conclusion

In this thesis, we observed that permanent grasslands and croplands can be complementary for beneficial entomofauna. Indeed, carabid assemblages in cropland and grassland remained mainly distinct, even though neighboring ones showed significant similarity, with about 20% of the overall species richness in common. In grasslands, we found a higher species richness when the landscape compositional diversity around was increased, except in the study region where the grasslands covered larger areas. The overall community from adjacent crop and grasslands was positively influenced by higher configurational heterogeneity.

Moreover, the common species richness sampled in both neighboring cereal fields and grasslands was enhanced by higher density of field borders between these two land cover types. Though the land cover type was by far the major determinant of carabid traits, landscape parameters also had a significant influence. Polyphagous species were more likely to appear in neighboring grassland and cereal crop. Phytophagous species were highly exclusive to grasslands, while predatory were in cereal crops. On the whole, mobile species were not affiliated to any of these two land cover types, and were more sampled in simplified landscapes.

The spider family richness was higher in permanent grasslands, though there were more individuals present in cereal fields. Moreover, spider density was fostered in vicinity of higher grassland coverage. Both hover flies and lacewings sampled density were higher in cereal fields and lower in the neighboring of higher grassland coverage.

One of our main finding is that higher adjacency between these two farmland cover types fosters the number of carabid species found in both, which we explain by landscape complementation. Moreover, these species common to grassland and cropland were able to provide potential biological control in cereal fields, by feeding on pests and weed seeds, as they were polyphagous and mobile.

Given these observations and the literature, we suggested some options to enhance functional biodiversity. Our main idea is to implement a grassland mosaic within more crop dominated landscapes, which could provide complementary and stable resource to this beneficial species, which could thereby move from one habitat to the other easily. Furthermore, it is possible to enhance the crop diversity of agricultural landscapes, but also within farms, still in order to provide a wider diversity of resource to natural enemies, as well as avoiding an overpopulation of specialized pests. Finally, another option we explored was the down-scaling of agricultural landscapes: smaller fields indeed would ease the movement of natural enemies from one field to another, as well as the colonization of the whole field to its core.

The simplification of crop rotations leads to a dependence to herbicides, pesticides and fungicides, which leads to a decline of biodiversity in the cropped fields vicinity (Kleijn and Verbeek 2000; Stoate et al. 2009). For instance, cereal yield is directly and negatively related to bird diversity (Donald et al. 2000). Indeed, by reducing invertebrate populations in size and diversity, intensive agriculture also negatively impacts on farmland bird populations (Benton et al. 2002). Moreover, the organization of the food industry is inefficient to end hunger despite levels of production above the needs, since one third of the global production is lost, either due to storage or wastage issues (De Schutter 2011; Foley et al. 2011), or as large areas of cropped areas are intended to feed cattle instead of people.

Then, a more global questioning is about the difficulty of the implementation of new practices or agri-environmental schemes, since every farmer decides on its own and can thereby take economic risks. Moreover, we saw that the question of economic and territorial governance highly matters since we consider the impact of landscape organization on farming activities (Altieri 2009; Ostrom 2015). There is indeed a growing need for new frameworks helping the collective decision-making by farmers and other stakeholders for managing agricultural landscapes, and thereby the biodiversity they host and the ecosystem services they provide (Martin et al. 2013; Lescourret et al. 2015).

These new governance models could be initiated by local authorities or chambers of agriculture, in order to help the farmers to organize. However, the lead should be left to the farmers, since they are the ones who would be economically affected in case of landscape change. These assemblies would then be able to discuss the best ways to adapt the farmland to the ecological issues, which is here, for instance, the lack of stable areas such as permanent grasslands. Finally, the assembly could also find ways to compensate the farmers who would make concessions, for the good of all.

All these issues lead us to consider the process of decision-making that impacts all of us but is constrained for economic reasons. However, we all want to have beautiful rural landscapes as well as food in our plates. We also want our farmers, the people feeding us, to live decently from their work, and, as much as possible, to work under bearable conditions.

The whole point there may be that what should be decided under democratic decisions, not only national votes, but also local communities, is still largely driven by economic constraints, which somehow escape from people's consent. Maybe it is time for us to question the primacy of economics over social-ecological matters, and then to build democracies more adapted to modern days challenges.

References

- Alhadidi SN, Griffin JN, Fowler MS (2018) Natural enemy composition rather than richness determines pest suppression. *BioControl* 63:575–584 . <https://doi.org/10.1007/s10526-018-9870-z>
- Alignier A, Aviron S (2017) Time-lagged response of carabid species richness and composition to past management practices and landscape context of semi-natural field margins. *J Environ Manage* 204:282–290 . <https://doi.org/10.1016/j.jenvman.2017.08.054>
- Alignier A, Raymond L, Deconchat M, Menozzi P, Monteil C, Sarthou J-P, Vialatte A, Ouin A (2014) The effect of semi-natural habitats on aphids and their natural enemies across spatial and temporal scales. *Biol Control* 77:76–82 . <https://doi.org/10.1016/j.biocontrol.2014.06.006>
- Allaire G (1988) Le modèle de développement agricole des années 1960. *Économie Rurale* 184:171–181 . <https://doi.org/10.3406/ecoru.1988.3908>
- Altieri M, Nicholls C, Nicholls C (2018) *Biodiversity and Pest Management in Agroecosystems*. CRC Press
- Altieri MA (1999) The ecological role of biodiversity in agroecosystems. *Agric Ecosyst Environ* 74:19–31 . [https://doi.org/10.1016/S0167-8809\(99\)00028-6](https://doi.org/10.1016/S0167-8809(99)00028-6)
- Altieri MA (2009) Agroecology, Small Farms and Food Sovereignty. *Mon Rev* 61:102–113
- Andersen E (2017) The farming system component of European agricultural landscapes. *Eur J Agron* 82:282–291 . <https://doi.org/10.1016/j.eja.2016.09.011>
- Andren H (1994) Effects of Habitat Fragmentation on Birds and Mammals in Landscapes with Different Proportions of Suitable Habitat - a Review. *Oikos* 71:355–366 . <https://doi.org/10.2307/3545823>
- Anjum-Zubair M, Entling MH, Bruckner A, Drapela T, Frank T (2015) Differentiation of spring carabid beetle assemblages between semi-natural habitats and adjoining winter wheat. *Agric For Entomol* 17:355–365 . <https://doi.org/10.1111/afe.12115>
- Arponen A, Heikkinen RK, Paloniemi R, Pöyry J, Similä J, Kuussaari M (2013) Improving conservation planning for semi-natural grasslands: Integrating connectivity into agri-environment schemes. *Biol Conserv* 160:234–241 . <https://doi.org/10.1016/j.biocon.2013.01.018>
- Aviron S, Burel F, Baudry J, Schermann N (2005) Carabid assemblages in agricultural landscapes: impacts of habitat features, landscape context at different spatial scales and farming intensity. *Agric Ecosyst Environ* 108:205–217 . <https://doi.org/10.1016/j.agee.2005.02.004>
- Bailey D, Herzog F, Augenstein I, Aviron S, Billeter R, Szerencsits E, Baudry J (2007) Thematic resolution matters: Indicators of landscape pattern for European agro-ecosystems. *Ecol Indic* 7:692–709 . <https://doi.org/10.1016/j.ecolind.2006.08.001>
- Baranová B, Fazekašová D, Jászay T, Manko P (2013) Ground beetle (Coleoptera: Carabidae) community of arable land with different crops. *Folia Faun Slovaca* 18:21–29
- Barbaro L, Halder IV (2009) Linking bird, carabid beetle and butterfly life-history traits to habitat fragmentation in mosaic landscapes. *Ecography* 32:321–333 . <https://doi.org/10.1111/j.1600-0587.2008.05546.x>

- Barbosa PA (1998) Conservation Biological Control. Elsevier
- Barton K (2018) MuMIn: multi-model inference (version 1.42. 1)
- Batáry P, Báldi A, Kleijn D, Tscharrntke T (2011) Landscape-moderated biodiversity effects of agri-environmental management: a meta-analysis. *Proc R Soc B Biol Sci* 278:1894–1902 . <https://doi.org/10.1098/rspb.2010.1923>
- Batáry P, Báldi A, Szél G, Podlussány A, Rozner I, Erdős S (2007) Responses of grassland specialist and generalist beetles to management and landscape complexity. *Divers Distrib* 13:196–202 . <https://doi.org/10.1111/j.1472-4642.2006.00309.x>
- Batáry P, Gallé R, Riesch F, Fischer C, Dormann CF, Musshoff O, Csaszar P, Fusaro S, Gayer C, Happe A-K, Kurucz K, Molnar D, Roesch V, Wietzke A, Tscharrntke T (2017) The former Iron Curtain still drives biodiversity-profit trade-offs in German agriculture. *Nat Ecol Evol* 1:1279–1284 . <https://doi.org/10.1038/s41559-017-0272-x>
- Batáry P, Holzschuh A, Orci KM, Samu F, Tscharrntke T (2012) Responses of plant, insect and spider biodiversity to local and landscape scale management intensity in cereal crops and grasslands. *Agric Ecosyst Environ* 146:130–136 . <https://doi.org/10.1016/j.agee.2011.10.018>
- Batáry P, Kovács A, Báldi A (2008) Management effects on carabid beetles and spiders in Central Hungarian grasslands and cereal fields. *Community Ecol* 9:247–254 . <https://doi.org/10.1556/ComEc.9.2008.2.14>
- Bates D, Mächler M, Bolker B, Walker S (2014) Fitting Linear Mixed-Effects Models using lme4. *ArXiv14065823 Stat*
- Baudry J, Merriam G (1988) Connectivity and connectedness: Functional versus structural patterns in landscapes
- Bengtsson J, Ahnström J, Weibull A-C (2005) The effects of organic agriculture on biodiversity and abundance: a meta-analysis. *J Appl Ecol* 42:261–269 . <https://doi.org/10.1111/j.1365-2664.2005.01005.x>
- Bengtsson J, Angelstam P, Elmqvist T, Emanuelsson U, Folke C, Ihse M, Moberg F, Nyström M (2003) Reserves, Resilience and Dynamic Landscapes. *AMBIO J Hum Environ* 32:389–396 . <https://doi.org/10.1579/0044-7447-32.6.389>
- Benton TG, Bryant DM, Cole L, Crick HQP (2002) Linking agricultural practice to insect and bird populations: a historical study over three decades. *J Appl Ecol* 39:673–687 . <https://doi.org/10.1046/j.1365-2664.2002.00745.x>
- Benton TG, Vickery JA, Wilson JD (2003) Farmland biodiversity: is habitat heterogeneity the key? *Trends Ecol Evol* 18:182–188 . [https://doi.org/10.1016/S0169-5347\(03\)00011-9](https://doi.org/10.1016/S0169-5347(03)00011-9)
- Bertrand C, Burel F, Baudry J (2016) Spatial and temporal heterogeneity of the crop mosaic influences carabid beetles in agricultural landscapes. *Landsc Ecol* 31:451–466 . <https://doi.org/10.1007/s10980-015-0259-4>
- Bianchi FJJA, Booij CJH, Tscharrntke T (2006) Sustainable pest regulation in agricultural landscapes: a review on landscape composition, biodiversity and natural pest control. *Proc R Soc Lond B Biol Sci* 273:1715–1727 . <https://doi.org/10.1098/rspb.2006.3530>

- Billetter R, Liira J, Bailey D, Bugter R, Arens P, Augenstein I, Aviron S, Baudry J, Bukacek R, Burel F, Cerny M, De Blust G, De Cock R, Diekötter T, Dietz H, Dirksen J, Dormann C, Durka W, Frenzel M, Hamersky R, Hendrickx F, Herzog F, Klotz S, Koolstra B, Lausch A, Le Coeur D, Maelfait JP, Opdam P, Roubalova M, Schermann A, Schermann N, Schmidt T, Schweiger O, Smulders M j. m., Speelmans M, Simova P, Verboom J, Van Wingerden W k. r. e., Zobel M, Edwards P j. (2008) Indicators for biodiversity in agricultural landscapes: a pan-European study. *J Appl Ecol* 45:141–150 . <https://doi.org/10.1111/j.1365-2664.2007.01393.x>
- Binder CR, Hinkel J, Bots PWG, Pahl-Wostl C (2013) Comparison of Frameworks for Analyzing Social-ecological Systems. *Ecol Soc* 18: . <https://doi.org/10.2307/26269404>
- Binswanger H (1986) Agricultural Mechanization: A Comparative Historical Perspective. *World Bank Res Obs* 1:27–56 . <https://doi.org/10.1093/wbro/1.1.27>
- Boatman ND, Rew LJ, Theaker AJ, Froud-Williams RJ (1994) The impact of nitrogen fertilizers on field margin flora. *Field Margins Integrating Agric Conserv* 209–214
- Boer PJD (1990) Density limits and survival of local populations in 64 carabid species with different powers of dispersal. *J Evol Biol* 3:19–48 . <https://doi.org/10.1046/j.1420-9101.1990.3010019.x>
- Bohac J (1999) Staphylinid beetles as bioindicators. *Agric Ecosyst Environ* 74:357–372 . [https://doi.org/10.1016/S0167-8809\(99\)00043-2](https://doi.org/10.1016/S0167-8809(99)00043-2)
- Bolker BM, Brooks ME, Clark CJ, Geange SW, Poulsen JR, Stevens MHH, White J-SS (2009) Generalized linear mixed models: a practical guide for ecology and evolution. *Trends Ecol Evol* 24:127–135 . <https://doi.org/10.1016/j.tree.2008.10.008>
- Borcard D, Legendre P (2012) Is the Mantel correlogram powerful enough to be useful in ecological analysis? A simulation study. *Ecology* 93:1473–1481 . <https://doi.org/10.1890/11-1737.1>
- Boscutti F, Sigura M, Gambon N, Lagazio C, Krüsi BO, Bonfanti P (2015) Conservation Tillage Affects Species Composition But Not Species Diversity: A Comparative Study in Northern Italy. *Environ Manage* 55:443–452 . <https://doi.org/10.1007/s00267-014-0402-z>
- Boutin C, Jobin B (1998) Intensity of Agricultural Practices and Effects on Adjacent Habitats. *Ecol Appl* 8:544–557 . [https://doi.org/10.1890/1051-0761\(1998\)008\[0544:IOAPAE\]2.0.CO;2](https://doi.org/10.1890/1051-0761(1998)008[0544:IOAPAE]2.0.CO;2)
- Bowler IR (1986) Intensification, Concentration and Specialisation in Agriculture: the case of the European Community. *Geography* 71:14–24
- Branquart E, Hemptinne J-L (2000) Selectivity in the exploitation of floral resources by hoverflies (Diptera: Syrphinae). *Ecography* 23:732–742 . <https://doi.org/10.1111/j.1600-0587.2000.tb00316.x>
- Bretagnolle V, Balent G, Thenail C, Berthet E (2012) Gestion de la biodiversité en milieu céréalier intensif : importance des prairies aux échelles locales et régionales. *Innov Agron* 22:31–43
- Brewer MJ, Goodell PB (2011) Approaches and Incentives to Implement Integrated Pest Management that Addresses Regional and Environmental Issues. *Annu Rev Entomol* 57:41–59 . <https://doi.org/10.1146/annurev-ento-120709-144748>
- Brotans L, Herrando S, Martin JL (2004) Bird assemblages in forest fragments within Mediterranean mosaics created by wild fires. *Landsc Ecol* 19:663–675

- Bryan KM, Wratten SD (1984) The responses of polyphagous predators to prey spatial heterogeneity: aggregation by carabid and staphylinid beetles to their cereal aphid prey. *Ecol Entomol* 9:251–259 . <https://doi.org/10.1111/j.1365-2311.1984.tb00849.x>
- Burel F, Baudry J (2005) Habitat quality and connectivity in agricultural landscapes: The role of land use systems at various scales in time. *Ecol Indic* 5:305–313 . <https://doi.org/10.1016/j.ecolind.2005.04.002>
- Burel F, Baudry J (1995) Species biodiversity in changing agricultural landscapes: A case study in the Pays d’Auge, France. *Agric Ecosyst Environ* 55:193–200 . [https://doi.org/10.1016/0167-8809\(95\)00614-X](https://doi.org/10.1016/0167-8809(95)00614-X)
- Burnham KP, Anderson DR (2002) *Model Selection and Multimodel Inference: A Practical Information-Theoretic Approach*. Springer Science & Business Media
- Burnham KP, Anderson DR (2004) Multimodel Inference: Understanding AIC and BIC in Model Selection. *Sociol Methods Res* 33:261–304 . <https://doi.org/10.1177/0049124104268644>
- Burnham KP, Anderson DR, Huyvaert KP (2011) AIC model selection and multimodel inference in behavioral ecology: some background, observations, and comparisons. *Behav Ecol Sociobiol* 65:23–35 . <https://doi.org/10.1007/s00265-010-1029-6>
- Butault J-P, Delame N, Jacquet F, Zardet G (2011) L’utilisation des pesticides en France : état des lieux et perspectives de réduction. *Notes Études Socio-Économiques* 7–26
- Butler SJ, Vickery JA, Norris K (2007) Farmland Biodiversity and the Footprint of Agriculture. *Science* 315:381–384 . <https://doi.org/10.1126/science.1136607>
- Cardoso P, Borges PAV, Veech JA (2009) Testing the performance of beta diversity measures based on incidence data: the robustness to undersampling. *Divers Distrib* 15:1081–1090 . <https://doi.org/10.1111/j.1472-4642.2009.00607.x>
- Caro G, Marrec R, Gauffre B, Roncoroni M, Augiron S, Bretagnolle V (2016) Multi-scale effects of agri-environment schemes on carabid beetles in intensive farmland. *Agric Ecosyst Environ* 229:48–56 . <https://doi.org/10.1016/j.agee.2016.05.009>
- Carson R (1962) *Silent Spring*, New Ed edition. Penguin Classics, London
- Ceballos G, Ehrlich PR (2018) The misunderstood sixth mass extinction. *Science* 360:1080–1081 . <https://doi.org/10.1126/science.aau0191>
- Ceballos G, Ehrlich PR, Barnosky AD, García A, Pringle RM, Palmer TM (2015) Accelerated modern human-induced species losses: Entering the sixth mass extinction. *Sci Adv* 1:e1400253 . <https://doi.org/10.1126/sciadv.1400253>
- Chabert A, Sarthou J-P (2017) Practices of conservation agriculture prevail over cropping systems and landscape heterogeneity in understanding the ecosystem service of aphid biocontrol. *Agric Ecosyst Environ* 249:70–79 . <https://doi.org/10.1016/j.agee.2017.08.005>
- Chabert A, Sarthou J-P (2020) Conservation agriculture as a promising trade-off between conventional and organic agriculture in bundling ecosystem services. *Agric Ecosyst Environ* 292:106815 . <https://doi.org/10.1016/j.agee.2019.106815>

- Chamberlain D e., Fuller R j., Bunce R g. h., Duckworth J c., Shrubbs M (2000) Changes in the abundance of farmland birds in relation to the timing of agricultural intensification in England and Wales. *J Appl Ecol* 37:771–788 . <https://doi.org/10.1046/j.1365-2664.2000.00548.x>
- Chaplin-Kramer R, Kremen C (2012) Pest control experiments show benefits of complexity at landscape and local scales. *Ecol Appl* 22:1936–1948 . <https://doi.org/10.1890/11-1844.1>
- Chaplin-Kramer R, O'Rourke ME, Blitzer EJ, Kremen C (2011) A meta-analysis of crop pest and natural enemy response to landscape complexity. *Ecol Lett* 14:922–932 . <https://doi.org/10.1111/j.1461-0248.2011.01642.x>
- Chiron F, Chargé R, Julliard R, Jiguet F, Muratet A (2014) Pesticide doses, landscape structure and their relative effects on farmland birds. *Agric Ecosyst Environ* 185:153–160 . <https://doi.org/10.1016/j.agee.2013.12.013>
- Chiverton PA, Sotherton NW (1991) The Effects of Beneficial Arthropods of the Exclusion of Herbicides from Cereal Crop Edges. *J Appl Ecol* 28:1027–1039 . <https://doi.org/10.2307/2404223>
- Choquenot D, Ruscoe WA (2003) Landscape complementation and food limitation of large herbivores: habitat-related constraints on the foraging efficiency of wild pigs. *J Anim Ecol* 72:14–26 . <https://doi.org/10.1046/j.1365-2656.2003.00676.x>
- Cizek O, Zamecnik J, Tropek R, Kocarek P, Konvicka M (2012) Diversification of mowing regime increases arthropods diversity in species-poor cultural hay meadows. *J Insect Conserv* 16:215–226 . <https://doi.org/10.1007/s10841-011-9407-6>
- Clough Y, Kruess A, Tscharrntke T (2007) Local and landscape factors in differently managed arable fields affect the insect herbivore community of a non-crop plant species. *J Appl Ecol* 44:22–28 . <https://doi.org/10.1111/j.1365-2664.2006.01239.x>
- Cole L, Brocklehurst S, Robertson, Harrison W, McCracken DI (2017) Exploring the interactions between resource availability and the utilisation of semi-natural habitats by insect pollinators in an intensive agricultural landscape
- Cole LJ, McCracken DI, Dennis P, Downie IS, Griffin AL, Foster GN, Murphy KJ, Waterhouse T (2002) Relationships between agricultural management and ecological groups of ground beetles (Coleoptera: Carabidae) on Scottish farmland. *Agric Ecosyst Environ* 93:323–336 . [https://doi.org/10.1016/S0167-8809\(01\)00333-4](https://doi.org/10.1016/S0167-8809(01)00333-4)
- Coll M, Guershon M (2002) Omnivory in Terrestrial Arthropods: Mixing Plant and Prey Diets. *Annu Rev Entomol* 47:267–297 . <https://doi.org/10.1146/annurev.ento.47.091201.145209>
- Concepción ED, Díaz M, Baquero RA (2008) Effects of landscape complexity on the ecological effectiveness of agri-environment schemes. *Landsc Ecol* 23:135–148 . <https://doi.org/10.1007/s10980-007-9150-2>
- Concepción ED, Díaz M, Kleijn D, Báldi A, Batáry P, Clough Y, Gabriel D, Herzog F, Holzschuh A, Knop E, Marshall EJP, Tscharrntke T, Verhulst J (2012) Interactive effects of landscape context constrain the effectiveness of local agri-environmental management. *J Appl Ecol* 49:695–705 . <https://doi.org/10.1111/j.1365-2664.2012.02131.x>

- Coombes DS, Sothertons NW (1986) The dispersal and distribution of polyphagous predatory Coleoptera in cereals. *Ann Appl Biol* 108:461–474 . <https://doi.org/10.1111/j.1744-7348.1986.tb01985.x>
- Costanza R, d’Arge R, Groot R de, Farber S, Grasso M, Hannon B, Limburg K, Naeem S, O’Neill RV, Paruelo J, Raskin RG, Sutton P, Belt M van den (1997) The value of the world’s ecosystem services and natural capital. *Nature* 387:253–260 . <https://doi.org/10.1038/387253a0>
- Coulon J, Pupier R, Queinnec E, Ollivier E, Richoux P (2011) Faune de France, 94-95. Coléoptères Carabiques - Compléments et mise à jour. Fédération française des sociétés de sciences naturelles, Paris, France
- Crutzen PJ (2016) Geology of Mankind. In: Crutzen PJ, Brauch HG (eds) Paul J. Crutzen: A Pioneer on Atmospheric Chemistry and Climate Change in the Anthropocene. Springer International Publishing, Cham, pp 211–215
- Crutzen PJ (2006) The “Anthropocene.” In: Ehlers E, Krafft T (eds) Earth System Science in the Anthropocene. Springer, Berlin, Heidelberg, pp 13–18
- Dabney SM, Delgado JA, Reeves DW (2001) Using Winter Cover Crops to Improve Soil and Water Quality. *Commun Soil Sci Plant Anal* 32:1221–1250 . <https://doi.org/10.1081/CSS-100104110>
- Dainese M, Isaac NJB, Powney GD, Bommarco R, Öckinger E, Kuussaari M, Pöyry J, Benton TG, Gabriel D, Hodgson JA, Kunin WE, Lindborg R, Sait SM, Marini L (2017a) Landscape simplification weakens the association between terrestrial producer and consumer diversity in Europe. *Glob Change Biol* 23:3040–3051 . <https://doi.org/10.1111/gcb.13601>
- Dainese M, Martin EA, Aizen MA, Albrecht M, Bartomeus I, Bommarco R, Carvalheiro LG, Chaplin-Kramer R, Gagic V, Garibaldi LA, Ghazoul J, Grab H, Jonsson M, Karp DS, Kennedy CM, Kleijn D, Kremen C, Landis DA, Letourneau DK, Marini L, Poveda K, Rader R, Smith HG, Tscharrntke T, Andersson GKS, Badenhausser I, Baensch S, Bezerra ADM, Bianchi FJJA, Boreux V, Bretagnolle V, Caballero-Lopez B, Cavigliasso P, Četković A, Chacoff NP, Classen A, Cusser S, Silva FD da S e, Groot GA de, Dudenhöffer JH, Ekroos J, Fijen T, Franck P, Freitas BM, Garratt MPD, Gratton C, Hipólito J, Holzschuh A, Hunt L, Iverson AL, Jha S, Keasar T, Kim TN, Kishinevsky M, Klatt BK, Klein A-M, Krewenka KM, Krishnan S, Larsen AE, Lavigne C, Liere H, Maas B, Mallinger RE, Pachon EM, Martínez-Salinas A, Meehan TD, Mitchell MGE, Molina GAR, Nesper M, Nilsson L, O’Rourke ME, Peters MK, Plečáš M, Potts SG, Ramos D de L, Rosenheim JA, Rundlöf M, Rusch A, Sáez A, Scheper J, Schleuning M, Schmack JM, Sciligo AR, Seymour C, Stanley DA, Stewart R, Stout JC, Sutter L, Takada MB, Taki H, Tamburini G, Tschumi M, Viana BF, Westphal C, Willcox BK, Wratten SD, Yoshioka A, Zaragoza-Trello C, Zhang W, Zou Y, Steffan-Dewenter I (2019) A global synthesis reveals biodiversity-mediated benefits for crop production. *Sci Adv* 5:eaax0121 . <https://doi.org/10.1126/sciadv.aax0121>
- Dainese M, Schneider G, Krauss J, Steffan-Dewenter I (2017b) Complementarity among natural enemies enhances pest suppression. *Sci Rep* 7:8172 . <https://doi.org/10.1038/s41598-017-08316-z>
- Danhardt J, Green M, Lindstrom A, Rundlof M, Smith HG (2010) Farmland as stopover habitat for migrating birds - effects of organic farming and landscape structure. *Oikos* 119:1114–1125 . <https://doi.org/10.1111/j.1600-0706.2009.18106.x>

- Dauber J, Purtauf T, Allspach A, Frisch J, Voigtländer K, Wolters V (2005) Local vs landscape controls on diversity: a test using surface-dwelling soil macroinvertebrates of differing mobility. *Glob Ecol Biogeogr* 14:213–221 . <https://doi.org/10.1111/j.1466-822X.2005.00150.x>
- Daucé P (2000) Développement et ruralité. *Économie Rurale* 255:114–119 . <https://doi.org/10.3406/ecoru.2000.5163>
- De Schutter O (2011) Report on the Right to Food. Un Human Right Council, New York, NY
- de Vries HH, den Boer PJ, van Dijk ThS (1996) Ground beetle species in heathland fragments in relation to survival, dispersal, and habitat preference. *Oecologia* 107:332–342 . <https://doi.org/10.1007/BF00328449>
- DeBach P, Rosen D (1991) Biological Control by Natural Enemies. CUP Archive
- Déjeant-Pons M (2006) The European Landscape Convention. *Landsc Res* 31:363–384 . <https://doi.org/10.1080/01426390601004343>
- DeJong TM (1975) A Comparison of Three Diversity Indices Based on Their Components of Richness and Evenness. *Oikos* 26:222–227 . <https://doi.org/10.2307/3543712>
- Dennis P, Thomas MB, Sotherton NW (1994) Structural Features of Field Boundaries Which Influence the Overwintering Densities of Beneficial Arthropod Predators. *J Appl Ecol* 31:361–370 . <https://doi.org/10.2307/2404550>
- Denno RF, Mitter MS, Langellotto GA, Gratton C, Finke DL (2004) Interactions between a hunting spider and a web-builder: consequences of intraguild predation and cannibalism for prey suppression. *Ecol Entomol* 29:566–577 . <https://doi.org/10.1111/j.0307-6946.2004.00628.x>
- Desriers M (2007) L'agriculture française depuis cinquante ans : des petites exploitations familiales aux droits à paiement unique. *AGRESTE Cah* 3–14
- Devictor V, Jiguet F (2007) Community richness and stability in agricultural landscapes: The importance of surrounding habitats. *Agric Ecosyst Environ* 120:179–184 . <https://doi.org/10.1016/j.agee.2006.08.013>
- Diehl E, Wolters V, Birkhofer K (2012) Arable weeds in organically managed wheat fields foster carabid beetles by resource- and structure-mediated effects. *Arthropod-Plant Interact* 6:75–82 . <https://doi.org/10.1007/s11829-011-9153-4>
- Diekötter T, Billeter R, Crist TO (2008) Effects of landscape connectivity on the spatial distribution of insect diversity in agricultural mosaic landscapes. *Basic Appl Ecol* 9:298–307 . <https://doi.org/10.1016/j.baae.2007.03.003>
- Dirzo R, Young HS, Galetti M, Ceballos G, Isaac NJB, Collen B (2014) Defaunation in the Anthropocene. *Science* 345:401–406 . <https://doi.org/10.1126/science.1251817>
- Djoudi EA, Plantegenest M, Aviron S, Pétilon J (2019) Local vs. landscape characteristics differentially shape emerging and circulating assemblages of carabid beetles in agroecosystems. *Agric Ecosyst Environ* 270–271:149–158 . <https://doi.org/10.1016/j.agee.2018.10.022>

- Dolédec S, Chessel D, ter Braak CJF, Champely S (1996) Matching species traits to environmental variables: a new three-table ordination method. *Environ Ecol Stat* 3:143–166 . <https://doi.org/10.1007/BF02427859>
- Donald PF, Green RE, Heath MF (2000) Agricultural intensification and the collapse of Europe's farmland bird populations. *R Soc* 25–29 . <https://doi.org/10.1098/rspb.2000.1325>
- Dorst J (1965) *Avant que nature meure, pour que nature vive*. Delachaux, Paris
- Dostálek J, Frantík T (2008) Dry grassland plant diversity conservation using low-intensity sheep and goat grazing management: case study in Prague (Czech Republic). *Biodivers Conserv* 17:1439–1454 . <https://doi.org/10.1007/s10531-008-9352-1>
- Drapela T, Moser D, Zaller JG, Frank T (2008) Spider assemblages in winter oilseed rape affected by landscape and site factors. *Ecography* 31:254–262 . <https://doi.org/10.1111/j.0906-7590.2008.5250.x>
- Dray S, Chessel D, Thioulouse J (2003) Co-Inertia Analysis and the Linking of Ecological Data Tables. *Ecology* 84:3078–3089 . <https://doi.org/10.1890/03-0178>
- Dray S, Dufour A-B, Thioulouse J (2018) Ade4: Analysis of Ecological Data: Exploratory and Euclidean Methods in Environmental Sciences (version 1.7-13). 409 . <https://doi.org/10.18637/jss.v022.i04>
- Dray S, Legendre P (2008) Testing the Species Traits–Environment Relationships: The Fourth-Corner Problem Revisited. *Ecology* 89:3400–3412 . <https://doi.org/10.1890/08-0349.1>
- Duelli P (1997) Biodiversity evaluation in agricultural landscapes: An approach at two different scales. *Agric Ecosyst Environ* 62:81–91 . [https://doi.org/10.1016/S0167-8809\(96\)01143-7](https://doi.org/10.1016/S0167-8809(96)01143-7)
- Duelli P, Obrist MK (2003a) Biodiversity indicators: the choice of values and measures. *Agric Ecosyst Environ* 98:87–98 . [https://doi.org/10.1016/S0167-8809\(03\)00072-0](https://doi.org/10.1016/S0167-8809(03)00072-0)
- Duelli P, Obrist MK (2003b) Regional biodiversity in an agricultural landscape: the contribution of seminatural habitat islands. *Basic Appl Ecol* 4:129–138 . <https://doi.org/10.1078/1439-1791-00140>
- Duelli P, Obrist MK, Schmatz DR (1999) Biodiversity evaluation in agricultural landscapes: above-ground insects. *Agric Ecosyst Environ* 74:33–64 . [https://doi.org/10.1016/S0167-8809\(99\)00029-8](https://doi.org/10.1016/S0167-8809(99)00029-8)
- Duelli P, Studer M, Marchand I, Jakob S (1990) Population movements of arthropods between natural and cultivated areas. *Biol Conserv* 54:193–207 . [https://doi.org/10.1016/0006-3207\(90\)90051-P](https://doi.org/10.1016/0006-3207(90)90051-P)
- Duflot R, Ernoult A, Aviron S, Fahrig L, Burel F (2017) Relative effects of landscape composition and configuration on multi-habitat gamma diversity in agricultural landscapes. *Agric Ecosyst Environ* 241:62–69 . <https://doi.org/10.1016/j.agee.2017.02.035>
- Duflot R, Ernoult A, Burel F, Aviron S (2016) Landscape level processes driving carabid crop assemblage in dynamic farmlands. *Popul Ecol* 58:265–275 . <https://doi.org/10.1007/s10144-015-0534-x>

- Duflot R, Georges R, Ernoult A, Aviron S, Burel F (2014) Landscape heterogeneity as an ecological filter of species traits. *Acta Oecologica-Int J Ecol* 56:19–26 . <https://doi.org/10.1016/j.actao.2014.01.004>
- Dumat C, Massaloux D, Limbertie A, Lardon S (2018) Comment designer une alimentation durable dans les territoires ? *Agric Environ Sociétés* 8:87–97
- Dunning JB, Danielson BJ, Pulliam HR (1992) Ecological Processes That Affect Populations in Complex Landscapes. *Oikos* 65:169–175 . <https://doi.org/10.2307/3544901>
- Ekbom BS, Wiktelius S, Chiverton PA (1992) Can polyphagous predators control the bird cherry-oat aphid (*Rhopalosiphum padi*) in spring cereals?: A simulation study. *Entomol Exp Appl* 65:215–223 . <https://doi.org/10.1111/j.1570-7458.1992.tb00674.x>
- Ekroos J, Olsson O, Rundlöf M, Wätzold F, Smith HG (2014) Optimizing agri-environment schemes for biodiversity, ecosystem services or both? *Biol Conserv* 172:65–71 . <https://doi.org/10.1016/j.biocon.2014.02.013>
- Ekschmitt K, Wolters V, Weber M (1997) Spiders, Carabids, and Staphylinids: The Ecological Potential of Predatory Macroarthropods. In: *Fauna in Soil Ecosystems: Recycling Processes, Nutrient Fluxes, and Agricultural Production*. Gero Benckiser, pp 307–362
- Elmqvist T, Folke C, Nyström M, Peterson G, Bengtsson J, Walker B, Norberg J (2003) Response diversity, ecosystem change, and resilience. *Front Ecol Environ* 1:488–494 . [https://doi.org/10.1890/1540-9295\(2003\)001\[0488:RDECAR\]2.0.CO;2](https://doi.org/10.1890/1540-9295(2003)001[0488:RDECAR]2.0.CO;2)
- Emmerson MC, Morales MB, Oñate JJ, Batary P, Berendse F, Liira J, Aavik T, Guerrero I, Bommarco R, Eggers S, Weisser W, Lars C, Bengtsson J (2016) How Agricultural Intensification Affects Biodiversity and Ecosystem Services. *Adv Ecol Res* 55:43–97 . <https://doi.org/10.1016/bs.aecr.2016.08.005>
- Eyre MD, Luff ML, Atlihan R, Leifert C (2012) Ground beetle species (Carabidae, Coleoptera) activity and richness in relation to crop type, fertility management and crop protection in a farm management comparison trial. *Ann Appl Biol* 161:169–179 . <https://doi.org/10.1111/j.1744-7348.2012.00562.x>
- Fahrig L (2003) Effects of Habitat Fragmentation on Biodiversity. *Annu Rev Ecol Evol Syst* 34:487–515
- Fahrig L, Baudry J, Brotons L, Burel FG, Crist TO, Fuller RJ, Sirami C, Siriwardena GM, Martin J-L (2011) Functional landscape heterogeneity and animal biodiversity in agricultural landscapes. *Ecol Lett* 14:101–112 . <https://doi.org/10.1111/j.1461-0248.2010.01559.x>
- Fahrig L, Girard J, Duro D, Pasher J, Smith A, Javorek S, King D, Lindsay K, Mitchell S, Tischendorf L (2015) Farmlands with smaller crop fields have higher within-field biodiversity. *Agric Ecosyst Environ* 200: . <https://doi.org/10.1016/j.agee.2014.11.018>
- Fiedler AK, Landis DA, Wratten SD (2008) Maximizing ecosystem services from conservation biological control: The role of habitat management. *Biol Control* 45:254–271 . <https://doi.org/10.1016/j.biocontrol.2007.12.009>
- Finke DL, Denno RF (2004) Predator diversity dampens trophic cascades. *Nature* 429:407–410 . <https://doi.org/10.1038/nature02554>

- Finke DL, Denno RF (2002) Intraguild Predation Diminished in Complex-Structured Vegetation: Implications for Prey Suppression. *Ecology* 83:643–652 . [https://doi.org/10.1890/0012-9658\(2002\)083\[0643:IPDICS\]2.0.CO;2](https://doi.org/10.1890/0012-9658(2002)083[0643:IPDICS]2.0.CO;2)
- Fischer AP, Charnley S (2012) Risk and Cooperation: Managing Hazardous Fuel in Mixed Ownership Landscapes. *Environ Manage* 49:1192–1207 . <https://doi.org/10.1007/s00267-012-9848-z>
- Fischer J, Lindenmayer DB (2006) Beyond fragmentation: the continuum model for fauna research and conservation in human-modified landscapes. *Oikos* 112:473–480 . <https://doi.org/10.1111/j.0030-1299.2006.14148.x>
- Fischer J, Lindenmayer DB (2007) Landscape modification and habitat fragmentation: a synthesis. *Glob Ecol Biogeogr* 16:265–280 . <https://doi.org/10.1111/j.1466-8238.2007.00287.x>
- Flohre A, Fischer C, Aavik T, Bengtsson J, Berendse F, Bommarco R, Ceryngier P, Clement LW, Dennis C, Eggers S, Emmerson M, Geiger F, Guerrero I, Hawro V, Inchausti P, Liira J, Morales MB, Oñate JJ, Pärt T, Weisser WW, Winqvist C, Thies C, Tscharrntke T (2011) Agricultural intensification and biodiversity partitioning in European landscapes comparing plants, carabids, and birds. *Ecol Appl* 21:1772–1781 . <https://doi.org/10.1890/10-0645.1>
- Foley JA, DeFries R, Asner GP, Barford C, Bonan G, Carpenter SR, Chapin FS, Coe MT, Daily GC, Gibbs HK, Helkowski JH, Holloway T, Howard EA, Kucharik CJ, Monfreda C, Patz JA, Prentice IC, Ramankutty N, Snyder PK (2005) Global consequences of land use. *Science* 309:570–574 . <https://doi.org/10.1126/science.1111772>
- Foley JA, Ramankutty N, Brauman KA, Cassidy ES, Gerber JS, Johnston M, Mueller ND, O’Connell C, Ray DK, West PC, Balzer C, Bennett EM, Carpenter SR, Hill J, Monfreda C, Polasky S, Rockström J, Sheehan J, Siebert S, Tilman D, Zaks DPM (2011) Solutions for a cultivated planet. *Nature* 478:337–342 . <https://doi.org/10.1038/nature10452>
- Forman RTT (1995) Some general principles of landscape and regional ecology. *Landsc Ecol* 10:133–142 . <https://doi.org/10.1007/BF00133027>
- Fournier E, Loreau M (1999) Effects of newly planted hedges on ground-beetle diversity (Coleoptera, Carabidae) in an agricultural landscape. *Ecography* 22:87–97 . <https://doi.org/10.1111/j.1600-0587.1999.tb00457.x>
- Frank JH, Thomas MC (2016) Rove Beetles of the World, Staphylinidae (Insecta : Coleoptera: Staphylinidae). 8
- Friedman M (1963) *Capitalism and Freedom*, 2nd edition. University of Chicago Press, Chicago
- Fusser MS, Pfister SC, Entling MH, Schirmel J (2017) Effects of field margin type and landscape composition on predatory carabids and slugs in wheat fields. *Agric Ecosyst Environ* 247:182–188 . <https://doi.org/10.1016/j.agee.2017.06.030>
- Gallé R, Császár P, Makra T, Gallé-Szpisjak N, Ladányi Z, Torma A, Ingle K, Szilassi P (2018a) Small-scale agricultural landscapes promote spider and ground beetle densities by offering suitable overwintering sites. *Landsc Ecol* 33:1435–1446 . <https://doi.org/10.1007/s10980-018-0677-1>
- Gallé R, Happe A-K, Baillod AB, Tscharrntke T, Batáry P (2018b) Landscape configuration, organic management, and within-field position drive functional diversity of spiders and carabids. *J Appl Ecol* 56:63–72 . <https://doi.org/10.1111/1365-2664.13257>

- Gámez-Virués S, Perović DJ, Gossner MM, Börschig C, Blüthgen N, Jong H de, Simons NK, Klein A-M, Krauss J, Maier G, Scherber C, Steckel J, Rothenwöhrer C, Steffan-Dewenter I, Weiner CN, Weisser W, Werner M, Tscharrntke T, Westphal C (2015) Landscape simplification filters species traits and drives biotic homogenization. *Nat Commun* 6:8568 . <https://doi.org/10.1038/ncomms9568>
- García-Tejero S, Taboada A (2016) Microhabitat heterogeneity promotes soil fertility and ground-dwelling arthropod diversity in Mediterranean wood-pastures. *Agric Ecosyst Environ* 233:192–201 . <https://doi.org/10.1016/j.agee.2016.09.004>
- Gardiner MM, Landis DA, Gratton C, Schmidt N, O’Neal M, Mueller E, Chacon J, Heimpel GE (2010) Landscape composition influences the activity density of Carabidae and Arachnida in soybean fields. *Biol Control* 55:11–19 . <https://doi.org/10.1016/j.biocontrol.2010.06.008>
- Garratt MPD, Senapathi D, Coston DJ, Mortimer SR, Potts SG (2017) The benefits of hedgerows for pollinators and natural enemies depends on hedge quality and landscape context. *Agric Ecosyst Environ* 247:363–370 . <https://doi.org/10.1016/j.agee.2017.06.048>
- Gavish-Regev E, Lubin Y, Coll M (2008) Migration patterns and functional groups of spiders in a desert agroecosystem. *Ecol Entomol* 33:202–212 . <https://doi.org/10.1111/j.1365-2311.2007.00958.x>
- Gayer C, Lövei GL, Magura T, Dieterich M, Batáry P (2019) Carabid functional diversity is enhanced by conventional flowering fields, organic winter cereals and edge habitats. *Agric Ecosyst Environ* 284:106579 . <https://doi.org/10.1016/j.agee.2019.106579>
- Geiger F, Bengtsson J, Berendse F, Weisser WW, Emmerson M, Morales MB, Ceryngier P, Liira J, Tscharrntke T, Winqvist C, Eggers S, Bommarco R, Pärt T, Bretagnolle V, Plantegenest M, Clement LW, Dennis C, Palmer C, Oñate JJ, Guerrero I, Hawro V, Aavik T, Thies C, Flohre A, Hänke S, Fischer C, Goedhart PW, Inchausti P (2010) Persistent negative effects of pesticides on biodiversity and biological control potential on European farmland. *Basic Appl Ecol* 11:97–105 . <https://doi.org/10.1016/j.baae.2009.12.001>
- Geiger F, Wäckers FL, Bianchi FJJA (2009) Hibernation of predatory arthropods in semi-natural habitats. *BioControl* 54:529–535 . <https://doi.org/10.1007/s10526-008-9206-5>
- Gerbaux F, Muller P (1984) La naissance du développement agricole en France. *Économie Rurale* 159:17–22 . <https://doi.org/10.3406/ecoru.1984.3019>
- Gibson RH, Knott B, Eberlein T, Memmott J (2011) Sampling method influences the structure of plant–pollinator networks. *Oikos* 120:822–831 . <https://doi.org/10.1111/j.1600-0706.2010.18927.x>
- Giller KE, Beare MH, Lavelle P, Izac A-MN, Swift MJ (1997) Agricultural intensification, soil biodiversity and agroecosystem function. *Appl Soil Ecol* 6:3–16 . [https://doi.org/10.1016/S0929-1393\(96\)00149-7](https://doi.org/10.1016/S0929-1393(96)00149-7)
- Giraud G, Renouard C (2015) Capitalisme. *Dict. Pensée Ecol.* 127–130
- Gontijo LM (2019) Engineering natural enemy shelters to enhance conservation biological control in field crops. *Biol Control* 130:155–163 . <https://doi.org/10.1016/j.biocontrol.2018.10.014>
- Gontijo LM, Beers EH, Snyder WE (2015) Complementary suppression of aphids by predators and parasitoids. *Biol Control* 90:83–91 . <https://doi.org/10.1016/j.biocontrol.2015.06.002>

- Goulson D (2014) REVIEW: An overview of the environmental risks posed by neonicotinoid insecticides. *J Appl Ecol* 977–987 . [https://doi.org/10.1111/1365-2664.12111@10.1111/\(ISSN\)1365-2664.POLLINATOR](https://doi.org/10.1111/1365-2664.12111@10.1111/(ISSN)1365-2664.POLLINATOR)
- Gove B, Power SA, Buckley GP, Ghazoul J (2007) Effects of herbicide spray drift and fertilizer overspread on selected species of woodland ground flora: comparison between short-term and long-term impact assessments and field surveys. *J Appl Ecol* 44:374–384 . <https://doi.org/10.1111/j.1365-2664.2007.01261.x>
- Grandchamp A-C, Bergamini A, Stofer S, Niemelä J, Duelli P, Scheidegger C (2005) The influence of grassland management on ground beetles (Carabidae, Coleoptera) in Swiss montane meadows. *Agric Ecosyst Environ* 110:307–317 . <https://doi.org/10.1016/j.agee.2005.04.018>
- Guerrero I, Martínez P, Morales MB, Oñate JJ (2010) Influence of agricultural factors on weed, carabid and bird richness in a Mediterranean cereal cropping system. *Agric Ecosyst Environ* 138:103–108 . <https://doi.org/10.1016/j.agee.2010.04.006>
- Guisan A, Edwards TC, Hastie T (2002) Generalized linear and generalized additive models in studies of species distributions: setting the scene. *Ecol Model* 157:89–100 . [https://doi.org/10.1016/S0304-3800\(02\)00204-1](https://doi.org/10.1016/S0304-3800(02)00204-1)
- Gustavsson E, Lennartsson T, Emanuelsson M (2007) Land use more than 200years ago explains current grassland plant diversity in a Swedish agricultural landscape. *Biol Conserv* 138:47–59 . <https://doi.org/10.1016/j.biocon.2007.04.004>
- Haenke S, Scheid B, Schaefer M, Tschardt T, Thies C (2009) Increasing syrphid fly diversity and density in sown flower strips within simple vs. complex landscapes. *J Appl Ecol* 46:1106–1114 . <https://doi.org/10.1111/j.1365-2664.2009.01685.x>
- Haila Y (2002) A Conceptual Genealogy of Fragmentation Research: From Island Biogeography to Landscape Ecology. *Ecol Appl* 12:321–334 . [https://doi.org/10.1890/1051-0761\(2002\)012\[0321:ACGOFR\]2.0.CO;2](https://doi.org/10.1890/1051-0761(2002)012[0321:ACGOFR]2.0.CO;2)
- Hails RS (2002) Assessing the risks associated with new agricultural practices. *Nature* 418:685–688 . <https://doi.org/10.1038/nature01016>
- Hajek AE, Eilenberg J (2018) *Natural Enemies: An Introduction to Biological Control*. Cambridge University Press
- Hallmann CA, Foppen RPB, van Turnhout CAM, de Kroon H, Jongejans E (2014) Declines in insectivorous birds are associated with high neonicotinoid concentrations. *Nature* 511:341–343 . <https://doi.org/10.1038/nature13531>
- Hanson HI, Palmu E, Birkhofer K, Smith HG, Hedlund K (2016) Agricultural Land Use Determines the Trait Composition of Ground Beetle Communities. *PLOS ONE* 11:e0146329 . <https://doi.org/10.1371/journal.pone.0146329>
- Happe A-K, Riesch F, Rösch V, Gallé R, Tschardt T, Batáry P (2018) Small-scale agricultural landscapes and organic management support wild bee communities of cereal field boundaries. *Agric Ecosyst Environ* 254:92–98 . <https://doi.org/10.1016/j.agee.2017.11.019>

- Haslett JR (1989) Adult feeding by holometabolous insects: pollen and nectar as complementary nutrient sources for *Rhingia campestris* (Diptera: Syrphidae). *Oecologia* 81:361–363 . <https://doi.org/10.1007/BF00377084>
- Hatten TD, Bosque-Pérez NA, Labonte JR, Guy SO, Eigenbrode SD (2007) Effects of Tillage on the Activity Density and Biological Diversity of Carabid Beetles in Spring and Winter Crops. *Environ Entomol* 36:356–368 . <https://doi.org/10.1093/ee/36.2.356>
- Hendrickx F, Maelfait J-P, Desender K, Aviron S, Bailey D, Diekötter T, Lens L, Liira J, Schweiger O, Speelmans M, Vandomme V, Bugter R (2009) Pervasive effects of dispersal limitation on within- and among-community species richness in agricultural landscapes. *Glob Ecol Biogeogr* 18:607–616 . <https://doi.org/10.1111/j.1466-8238.2009.00473.x>
- Hendrickx F, Maelfait J-P, Van Wingerden W, Schweiger O, Speelmans M, Aviron S, Augenstein I, Billeter R, Bailey D, Bukacek R, Burel F, Diekötter T, Dirksen J, Herzog F, Liira J, Roubalova M, Vandomme V, Bugter R (2007) How landscape structure, land-use intensity and habitat diversity affect components of total arthropod diversity in agricultural landscapes. *J Appl Ecol* 44:340–351 . <https://doi.org/10.1111/j.1365-2664.2006.01270.x>
- Henle K, Davies KF, Kleyer M, Margules C, Settele J (2004) Predictors of Species Sensitivity to Fragmentation. *Biodivers Conserv* 13:207–251 . <https://doi.org/10.1023/B:BIOC.0000004319.91643.9e>
- Henle K, Kaule G (1991) Artenund Biotopschutzforschung für Deutschland. Forschungszentrum Jülich, Jülich
- Hickman JM, Wratten SD (1996) Use of *Phelia tanacetifolia* Strips To Enhance Biological Control of Aphids by Overfly Larvae in Cereal Fields. *J Econ Entomol* 89:832–840 . <https://doi.org/10.1093/jee/89.4.832>
- Hodge MA (1999) The Implications of Intraguild Predation for the Role of Spiders in Biological Control. *J Arachnol* 27:351–362
- Hoef JMV, Boveng PL (2007) Quasi-Poisson Vs. Negative Binomial Regression: How Should We Model Overdispersed Count Data? *Ecology* 88:2766–2772 . <https://doi.org/10.1890/07-0043.1>
- Holland JM (2002) Carabid beetles : Their ecology, survival and use in agroecosystems. *Agroecol Carabid Beetles*
- Holland JM, Douma JC, Crowley L, James L, Kor L, Stevenson DRW, Smith BM (2017) Semi-natural habitats support biological control, pollination and soil conservation in Europe. A review. *Agron Sustain Dev* 37:31 . <https://doi.org/10.1007/s13593-017-0434-x>
- Holland JM, Luff ML (2000) The Effects of Agricultural Practices on Carabidae in Temperate Agroecosystems. *Integr Pest Manag Rev* 5:109–129 . <https://doi.org/10.1023/A:1009619309424>
- Holland JM, Oaten H, Moreby S, Birkett T, Simper J, Southway S, Smith BM (2012) Agri-environment scheme enhancing ecosystem services: A demonstration of improved biological control in cereal crops. *Agric Ecosyst Environ* 155:147–152 . <https://doi.org/10.1016/j.agee.2012.04.014>

- Holland JM, Reynolds CJM (2003) The impact of soil cultivation on arthropod (Coleoptera and Araneae) emergence on arable land. *Pedobiologia* 47:181–191 . <https://doi.org/10.1078/0031-4056-00181>
- Holland JM, Thomas CFG, Birkett T, Southway S, Oaten H (2005) Farm-scale spatiotemporal dynamics of predatory beetles in arable crops. *J Appl Ecol* 42:1140–1152 . <https://doi.org/10.1111/j.1365-2664.2005.01083.x>
- Holland JM, Winder L, Woolley C, Alexander CJ, Perry JN (2004) The spatial dynamics of crop and ground active predatory arthropods and their aphid prey in winter wheat. *Bull Entomol Res* 94:419–431 . <https://doi.org/10.1079/BER2004323>
- Holt RD, Polis GA (1997) A Theoretical Framework for Intraguild Predation. *Am Nat* 149:745–764 . <https://doi.org/10.1086/286018>
- Holzschuh A, Steffan-Dewenter I, Tschamntke T (2008) Agricultural landscapes with organic crops support higher pollinator diversity. *Oikos* 117:354–361 . <https://doi.org/10.1111/j.2007.0030-1299.16303.x>
- Husson J-P, Marochini E (1997) Les remembrements agricoles entre économie et écologie. *Noroi* 173:195–208 . <https://doi.org/10.3406/noroi.1997.6780>
- Huyghe C (2009) Evolution des prairies et cultures fourragères et de leurs modalités culturales et d'utilisation en France au cours des cinquante dernières années. *Fourrages* 407–428
- IPBES (2018a) The IPBES regional assessment report on biodiversity and ecosystem services for Europe and Central Asia. Intergovernmental Science-Policy Platform on Biodiversity and Ecosystem Services, Bonn, Germany
- IPBES (2018b) The IPBES assessment report on land degradation and restoration. Intergovernmental Science-Policy Platform on Biodiversity and Ecosystem Services, Bonn, Germany
- IUCN French Committee (2019) IUCN Red list of threatened species in France
- Ives AR, Cardinale BJ, Snyder WE (2005) A synthesis of subdisciplines: predator–prey interactions, and biodiversity and ecosystem functioning. *Ecol Lett* 8:102–116 . <https://doi.org/10.1111/j.1461-0248.2004.00698.x>
- Jeannel R (1942) Faune de France n°40 - Coléoptères carabiques Tome II. Lechevalier, Paris, France
- Jeannel R (1941) Faune de France n°39 - Coléoptères carabiques Tome I. Lechevalier, Paris, France
- Johnson JB, Omland KS (2004) Model selection in ecology and evolution. *Trends Ecol Evol* 19:101–108 . <https://doi.org/10.1016/j.tree.2003.10.013>
- Jonason D, Smith HG, Bengtsson J, Birkhofer K (2013) Landscape simplification promotes weed seed predation by carabid beetles (Coleoptera: Carabidae). *Landsc Ecol* 28:487–494 . <https://doi.org/10.1007/s10980-013-9848-2>
- Jonsen ID, Fahrig L (1997) Response of generalist and specialist insect herbivores to landscape spatial structure. *Landsc Ecol* 12:185–197 . <https://doi.org/10.1023/A:1007961006232>

- Jonsson M, Wratten SD, Landis DA, Gurr GM (2008) Recent advances in conservation biological control of arthropods by arthropods. *Biol Control* 45:172–175 .
<https://doi.org/10.1016/j.biocontrol.2008.01.006>
- Jost L, Chao A, Chazdon RL (2011) Compositional similarity and beta diversity. In: *Biological diversity: frontiers in measurement and assessment*. Oxford University Press, Oxford, United Kingdom, pp 66–84
- Jowett K, Milne AE, Metcalfe H, Hassall KL, Potts SG, Senapathi D, Storkey J (2019) Species matter when considering landscape effects on carabid distributions. *Agric Ecosyst Environ* 285:106631 .
<https://doi.org/10.1016/j.agee.2019.106631>
- Karp DS, Chaplin-Kramer R, Meehan TD, Martin EA, DeClerck F, Grab H, Gratton C, Hunt L, Larsen AE, Martínez-Salinas A, O'Rourke ME, Rusch A, Poveda K, Jonsson M, Rosenheim JA, Schellhorn NA, Tscharrntke T, Wratten SD, Zhang W, Iverson AL, Adler LS, Albrecht M, Alignier A, Angelella GM, Anjum MZ, Avelino J, Batáry P, Baveco JM, Bianchi FJJA, Birkhofer K, Bohnenblust EW, Bommarco R, Brewer MJ, Caballero-López B, Carrière Y, Carvalheiro LG, Cayuela L, Centrella M, Četković A, Henri DC, Chabert A, Costamagna AC, Mora AD la, Kraker J de, Desneux N, Diehl E, Diekötter T, Dormann CF, Eckberg JO, Entling MH, Fiedler D, Franck P, Veen FJF van, Frank T, Gagic V, Garratt MPD, Getachew A, Gonthier DJ, Goodell PB, Graziosi I, Groves RL, Gurr GM, Hajian-Forooshani Z, Heimpel GE, Herrmann JD, Huseeth AS, Inclán DJ, Ingrao AJ, Iv P, Jacot K, Johnson GA, Jones L, Kaiser M, Kaser JM, Keasar T, Kim TN, Kishinevsky M, Landis DA, Lavandero B, Lavigne C, Ralec AL, Lemessa D, Letourneau DK, Liere H, Lu Y, Lubin Y, Luttermoser T, Maas B, Mace K, Madeira F, Mader V, Cortesero AM, Marini L, Martinez E, Martinson HM, Menozzi P, Mitchell MGE, Miyashita T, Molina GAR, Molina-Montenegro MA, O'Neal ME, Opatovsky I, Ortiz-Martinez S, Nash M, Östman Ö, Ouin A, Pak D, Paredes D, Parsa S, Parry H, Perez-Alvarez R, Perović DJ, Peterson JA, Petit S, Philpott SM, Plantegenest M, Plečaš M, Pluess T, Pons X, Potts SG, Pywell RF, Ragsdale DW, Rand TA, Raymond L, Ricci B, Sargent C, Sarthou J-P, Saulais J, Schäckermann J, Schmidt NP, Schneider G, Schüepp C, Sivakoff FS, Smith HG, Whitney KS, Stutz S, Szendrei Z, Takada MB, Taki H, Tamburini G, Thomson LJ, Tricault Y, Tsafack N, Tschumi M, Valantin-Morison M, Trinh MV, Werf W van der, Vierling KT, Werling BP, Wickens JB, Wickens VJ, Woodcock BA, Wyckhuys K, Xiao H, Yasuda M, Yoshioka A, Zou Y (2018) Crop pests and predators exhibit inconsistent responses to surrounding landscape composition. *Proc Natl Acad Sci* 115:E7863–E7870 .
<https://doi.org/10.1073/pnas.1800042115>
- Kearns CA, Inouye DW, Waser NM (1998) Endangered mutualisms: The Conservation of Plant-Pollinator Interactions. *Annu Rev Ecol Syst* 29:83–112 .
<https://doi.org/10.1146/annurev.ecolsys.29.1.83>
- Kennedy CM, Lonsdorf E, Neel MC, Williams NM, Ricketts TH, Winfree R, Bommarco R, Brittain C, Burley AL, Cariveau D, Carvalheiro LG, Chacoff NP, Cunningham SA, Danforth BN, Dudenhöffer J-H, Elle E, Gaines HR, Garibaldi LA, Gratton C, Holzschuh A, Isaacs R, Javorek SK, Jha S, Klein AM, Krewenka K, Mandelik Y, Mayfield MM, Morandin L, Neame LA, Otieno M, Park M, Potts SG, Rundlöf M, Saez A, Steffan-Dewenter I, Taki H, Viana BF, Westphal C, Wilson JK, Greenleaf SS, Kremen C (2013) A global quantitative synthesis of local and landscape effects on wild bee pollinators in agroecosystems. *Ecol Lett* 16:584–599 .
<https://doi.org/10.1111/ele.12082>
- Kessler SC, Tiedeken EJ, Simcock KL, Derveau S, Mitchell J, Softley S, Radcliffe A, Stout JC, Wright GA (2015) Bees prefer foods containing neonicotinoid pesticides. *Nature* 521:74–76 .
<https://doi.org/10.1038/nature14414>

- Kladivko EJ (2001) Tillage systems and soil ecology. *Soil Tillage Res* 61:61–76 . [https://doi.org/10.1016/S0167-1987\(01\)00179-9](https://doi.org/10.1016/S0167-1987(01)00179-9)
- Kleijn D, Sutherland WJ (2003) How effective are European agri-environment schemes in conserving and promoting biodiversity? *J Appl Ecol* 40:947–969 . <https://doi.org/10.1111/j.1365-2664.2003.00868.x>
- Kleijn D, van Langevelde F (2006) Interacting effects of landscape context and habitat quality on flower visiting insects in agricultural landscapes. *Basic Appl Ecol* 7:201–214 . <https://doi.org/10.1016/j.baae.2005.07.011>
- Kleijn D, Verbeek M (2000) Factors affecting the species composition of arable field boundary vegetation. *J Appl Ecol* 37:256–266 . <https://doi.org/10.1046/j.1365-2664.2000.00486.x>
- Kleyer M, Dray S, Bello F, Lepš J, Pakeman RJ, Strauss B, Thuiller W, Lavorel S (2012) Assessing species and community functional responses to environmental gradients: which multivariate methods? *J Veg Sci* 23:805–821 . <https://doi.org/10.1111/j.1654-1103.2012.01402.x>
- Klimeš P, Saska P (2010) Larval and adult seed consumption affected by the degree of food specialization in *Amara* (Coleoptera: Carabidae). *J Appl Entomol* 134:659–666 . <https://doi.org/10.1111/j.1439-0418.2009.01463.x>
- Knapp M, Řezáč M (2015) Even the Smallest Non-Crop Habitat Islands Could Be Beneficial: Distribution of Carabid Beetles and Spiders in Agricultural Landscape. *PLOS ONE* 10:e0123052 . <https://doi.org/10.1371/journal.pone.0123052>
- Koivula M, Kotze DJ, Hiisivuori L, Rita H (2003) Pitfall trap efficiency: do trap size, collecting fluid and vegetation structure matter? *Entomol Fenn* 14:1–14
- Kovář P (1992) Ecotones in agricultural landscape. *Ekológia* 11:251–258
- Kromp B (1999) Carabid beetles in sustainable agriculture: a review on pest control efficacy, cultivation impacts and enhancement. In: Paoletti MG (ed) *Invertebrate Biodiversity as Bioindicators of Sustainable Landscapes*. Elsevier, Amsterdam, pp 187–228
- Kromp B (1989) Carabid beetle communities (Carabidae, coleoptera) in biologically and conventionally farmed agroecosystems. *Agric Ecosyst Environ* 27:241–251 . [https://doi.org/10.1016/0167-8809\(89\)90089-3](https://doi.org/10.1016/0167-8809(89)90089-3)
- Kruess A, Tscharrntke T (2002) Contrasting responses of plant and insect diversity to variation in grazing intensity. *Biol Conserv* 106:293–302 . [https://doi.org/10.1016/S0006-3207\(01\)00255-5](https://doi.org/10.1016/S0006-3207(01)00255-5)
- Labreuche J, Le Souder C, Castillon P, Real B, Ouvry J-F, Germon J-C, de Tourdonnet S (2011) Evaluation des impacts environnementaux des Techniques Culturelles Sans Labour en France. ADEME-ARVALIS Institut du végétal-INRA-APCA-AREAS-ITB-CETIOM-IFVV, Paris, France
- Labruyere S, Bohan DA, Biju-Duval L, Ricci B, Petit S (2016) Local, neighbor and landscape effects on the abundance of weed seed-eating carabids in arable fields: A nationwide analysis. *Basic Appl Ecol* 17:230–239 . <https://doi.org/10.1016/j.baae.2015.10.008>
- Labruyere S, Petit S, Ricci B (2018) Annual variation of oilseed rape habitat quality and role of grassy field margins for seed eating carabids in arable mosaics. *Agric For Entomol* 20:234–245 . <https://doi.org/10.1111/afe.12250>

- Landis DA (2017) Designing agricultural landscapes for biodiversity-based ecosystem services. *Basic Appl Ecol* 18:1–12 . <https://doi.org/10.1016/j.baae.2016.07.005>
- Landis DA, Wratten SD, Gurr GM (2000) Habitat Management to Conserve Natural Enemies of Arthropod Pests in Agriculture. *Annu Rev Entomol* 45:175–201 . <https://doi.org/10.1146/annurev.ento.45.1.175>
- Lang A (2000) The pitfalls of pitfalls: a comparison of pitfall trap catches and absolute density estimates of epigeal invertebrate predators in Arable Land. *Anz Für Schädlingkunde J Pest Sci* 73:99–106 . <https://doi.org/10.1007/BF02956438>
- Lang A (2003) Intraguild interference and biocontrol effects of generalist predators in a winter wheat field. *Oecologia* 134:144–153 . <https://doi.org/10.1007/s00442-002-1091-5>
- Le Féon V, Schermann-Legionnet A, Delettre Y, Aviron S, Billeter R, Bugter R, Hendrickx F, Burel F (2010) Intensification of agriculture, landscape composition and wild bee communities: A large scale study in four European countries. *Agric Ecosyst Environ* 137:143–150 . <https://doi.org/10.1016/j.agee.2010.01.015>
- Lee JC, Menalled FB, Landis DA (2001a) Refuge habitats modify impact of insecticide disturbance on carabid beetle communities. *J Appl Ecol* 38:472–483 . <https://doi.org/10.1046/j.1365-2664.2001.00602.x>
- Lee JC, Menalled FD, Landis DA (2001b) Refuge habitats modify impact of insecticide disturbance on carabid beetle communities. *J Appl Ecol* 38:472–483 . <https://doi.org/10.1046/j.1365-2664.2001.00602.x>
- Legendre P, Borcard D, Peres-Neto PR (2005) Analyzing Beta Diversity: Partitioning the Spatial Variation of Community Composition Data. *Ecol Monogr* 75:435–450 . <https://doi.org/10.1890/05-0549>
- Legendre P, Gallagher ED (2001) Ecologically meaningful transformations for ordination of species data. *Oecologia* 129:271–280 . <https://doi.org/10.1007/s004420100716>
- Lemic D, Cacija M, Gasparic VH, Drmic Z, Bazok R, Zivkovic P (2017) The Ground Beetle (coleoptera: Carabidae) Community in an Intensively Managed Agricultural Landscape. *Appl Ecol Environ Res* 15:661–674 . https://doi.org/10.15666/aeer/1504_661674
- Lemke A, Poehling H-M (2002) Sown weed strips in cereal fields: overwintering site and “source” habitat for *Oedothorax apicatus* (Blackwall) and *Erigone atra* (Blackwall) (Araneae: Erigonidae). *Agric Ecosyst Environ* 90:67–80 . [https://doi.org/10.1016/S0167-8809\(01\)00173-6](https://doi.org/10.1016/S0167-8809(01)00173-6)
- Leopold A (2014) The Land Ethic. In: Ndubisi FO (ed) *The Ecological Design and Planning Reader*. Island Press/Center for Resource Economics, Washington, DC, pp 108–121
- Lescourret F, Magda D, Richard G, Adam-Blondon A-F, Bardy M, Baudry J, Doussan I, Dumont B, Lefèvre F, Litrico I, Martin-Clouaire R, Montuelle B, Pellerin S, Plantegenest M, Tancoigne E, Thomas A, Guyomard H, Soussana J-F (2015) A social–ecological approach to managing multiple agro-ecosystem services. *Curr Opin Environ Sustain* 14:68–75 . <https://doi.org/10.1016/j.cosust.2015.04.001>
- Letourneau DK, Armbrrecht I, Rivera BS, Lerma JM, Carmona EJ, Daza MC, Escobar S, Galindo V, Gutiérrez C, López SD, Mejía JL, Rangel AMA, Rangel JH, Rivera L, Saavedra CA, Torres AM,

- Trujillo AR (2011) Does plant diversity benefit agroecosystems? A synthetic review. *Ecol Appl* 21:9–21 . <https://doi.org/10.1890/09-2026.1>
- Lindén A, Mäntyniemi S (2011) Using the negative binomial distribution to model overdispersion in ecological count data. *Ecology* 92:1414–1421 . <https://doi.org/10.1890/10-1831.1>
- Lindgren J, Lindborg R, Cousins SAO (2018) Local conditions in small habitats and surrounding landscape are important for pollination services, biological pest control and seed predation. *Agric Ecosyst Environ* 251:107–113 . <https://doi.org/10.1016/j.agee.2017.09.025>
- Lindroth CH (1992) Ground Beetles (Carabidae) of Fennoscandia: Specific Knowledge Regarding the Species Pt. 1: A Zoogeographic Study. Intercept Ltd, Andover, Hampshire
- Long R, Corbett A, Lamb C, Reberg-Horton C, Chandler J, Stimmann M (1998) Beneficial insects move from flowering plants to nearby crops. *Calif Agric* 52:23–26
- Loreau M, Mouquet N, Gonzalez A (2003) Biodiversity as spatial insurance in heterogeneous landscapes. *Proc Natl Acad Sci* 100:12765–12770 . <https://doi.org/10.1073/pnas.2235465100>
- Losey JE, Denno RF (1998) Positive Predator–Predator Interactions: Enhanced Predation Rates and Synergistic Suppression of Aphid Populations. *Ecology* 79:2143–2152 . [https://doi.org/10.1890/0012-9658\(1998\)079\[2143:PPPIEP\]2.0.CO;2](https://doi.org/10.1890/0012-9658(1998)079[2143:PPPIEP]2.0.CO;2)
- Lucas É (2013) Intraguild predation among aphidophagous predators. *EJE* 102:351–364 . <https://doi.org/10.14411/eje.2005.052>
- Luff ML (1996) Use of Carabids as environmental indicators in grasslands and cereals. *Ann Zool Fenn* 33:185–195
- Lyons A, Ashton PA, Powell I, Oxbrough A (2017) Impacts of contrasting conservation grazing management on plants and carabid beetles in upland calcareous grasslands. *Agric Ecosyst Environ* 244:22–31 . <https://doi.org/10.1016/j.agee.2017.04.020>
- Madeira F, Tscharnkte T, Elek Z, Kormann UG, Pons X, Rösch V, Samu F, Scherber C, Batáry P (2016) Spillover of arthropods from cropland to protected calcareous grassland – the neighbouring habitat matters. *Agric Ecosyst Environ* 235:127–133 . <https://doi.org/10.1016/j.agee.2016.10.012>
- Maes D, Dyck HV (2005) Habitat quality and biodiversity indicator performances of a threatened butterfly versus a multispecies group for wet heathlands in Belgium. *Biol Conserv* 123:177–187 . <https://doi.org/10.1016/j.biocon.2004.11.005>
- Magura T, Bogyó D, Mizser S, Nagy DD, Tóthmérész B (2015) Recovery of ground-dwelling assemblages during reforestation with native oak depends on the mobility and feeding habits of the species. *For Ecol Manag* 339:117–126 . <https://doi.org/10.1016/j.foreco.2014.12.015>
- Magura T, Lovei GL (2019) Environmental filtering is the main assembly rule of ground beetles in the forest and its edge but not in the adjacent grassland. *Insect Sci* 26:154–163 . <https://doi.org/10.1111/1744-7917.12504>
- Magura T, Lövei GL, Tóthmérész B (2017) Edge responses are different in edges under natural versus anthropogenic influence: a meta-analysis using ground beetles. *Ecol Evol* 7:1009–1017 . <https://doi.org/10.1002/ece3.2722>

- Marrec R, Caro G, Miguët P, Badenhäusser I, Plantegenest M, Vialatte A, Bretagnolle V, Gauffre B (2017) Spatiotemporal dynamics of the agricultural landscape mosaic drives distribution and abundance of dominant carabid beetles. *Landsc Ecol* 32:2383–2398 . <https://doi.org/10.1007/s10980-017-0576-x>
- Marshall EJP, Moonen AC (2002) Field margins in northern Europe: their functions and interactions with agriculture. *Agric Ecosyst Environ* 89:5–21 . [https://doi.org/10.1016/S0167-8809\(01\)00315-2](https://doi.org/10.1016/S0167-8809(01)00315-2)
- Marshall J, Baudry J, Burel F, Joenje W, Gerowitt B, Paoletti M, Thomas G, Kleijn D, Le Coeur D, Moonen C (2001) Field Boundary Habitats for Wildlife, Crop, and Environmental Protection. In: *Landscape Ecology in Agroecosystems Management*. CRC Press, pp 219–247
- Martin G, Martin-Clouaire R, Duru M (2013) Farming system design to feed the changing world. A review. *Agron Sustain Dev* 33:131–149 . <https://doi.org/10.1007/s13593-011-0075-4>
- Massaloux D, Sarrazin B, Roume A, Tolon V, Wezel A (under review) Complementarity of grasslands and cereal fields ensures carabid regional diversity in French farmlands. *Biodivers Conserv*
- Matson PA, Parton WJ, Power AG, Swift MJ (1997) Agricultural Intensification and Ecosystem Properties. *Science* 277:504–509 . <https://doi.org/10.1126/science.277.5325.504>
- Mauremooto JR, Wratten SD, Worner SP, Fry GLA (1995) Permeability of hedgerows to predatory carabid beetles. *Agric Ecosyst Environ* 52:141–148 . [https://doi.org/10.1016/0167-8809\(94\)00548-S](https://doi.org/10.1016/0167-8809(94)00548-S)
- Mazoyer M, Roudart L (2006) *A History of World Agriculture: From the Neolithic Age to the Current Crisis*. NYU Press
- McCrary KW (2018) A Review of Sampling and Monitoring Methods for Beneficial Arthropods in Agroecosystems. *Insects* 9:170 . <https://doi.org/10.3390/insects9040170>
- McEwen PK, New TR, Whittington AE (2007) *Lacewings in the Crop Environment*. Cambridge University Press
- Melbourne BA (1999) Bias in the effect of habitat structure on pitfall traps: An experimental evaluation. *Aust J Ecol* 24:228–239 . <https://doi.org/10.1046/j.1442-9993.1999.00967.x>
- Melnychuk NA, Olfert O, Youngs B, Gillott C (2003) Abundance and diversity of Carabidae (Coleoptera) in different farming systems. *Agric Ecosyst Environ* 95:69–72 . [https://doi.org/10.1016/S0167-8809\(02\)00119-6](https://doi.org/10.1016/S0167-8809(02)00119-6)
- Menalled F, Lee J, Landis D (2001) Herbaceous Filter Strips in Agroecosystems: Implications for Ground Beetle (Coleoptera: Carabidae) Conservation and Invertebrate Weed Seed Predation. *Gt Lakes Entomol* 34:
- Menalled FD, Smith RG, Dauer JT, Fox TB (2007) Impact of agricultural management on carabid communities and weed seed predation. *Agric Ecosyst Environ* 118:49–54 . <https://doi.org/10.1016/j.agee.2006.04.011>
- Merckx T, Feber RE, Dulieu RL, Townsend MC, Parsons MS, Bourn NAD, Riordan P, Macdonald DW (2009) Effect of field margins on moths depends on species mobility: Field-based evidence for

- landscape-scale conservation. *Agric Ecosyst Environ* 129:302–309 .
<https://doi.org/10.1016/j.agee.2008.10.004>
- Meyer B, Jauker F, Steffan-Dewenter I (2009) Contrasting resource-dependent responses of hoverfly richness and density to landscape structure. *Basic Appl Ecol* 10:178–186 .
<https://doi.org/10.1016/j.baae.2008.01.001>
- Miguet P, Gaucherel C, Bretagnolle V (2013) Breeding habitat selection of Skylarks varies with crop heterogeneity, time and spatial scale, and reveals spatial and temporal crop complementation. *Ecol Model* 266:10–18 . <https://doi.org/10.1016/j.ecolmodel.2013.06.029>
- Miyashita T, Chishiki Y, Takagi SR (2012) Landscape heterogeneity at multiple spatial scales enhances spider species richness in an agricultural landscape. *Popul Ecol* 54:573–581 .
<https://doi.org/10.1007/s10144-012-0329-2>
- Moonen A-C, Bàrberi P (2008) Functional biodiversity: An agroecosystem approach. *Agric Ecosyst Environ* 127:7–21 . <https://doi.org/10.1016/j.agee.2008.02.013>
- Moore JW (2017) The Capitalocene, Part I: on the nature and origins of our ecological crisis. *J Peasant Stud* 44:594–630 . <https://doi.org/10.1080/03066150.2016.1235036>
- Moore JW (2018) The Capitalocene Part II: accumulation by appropriation and the centrality of unpaid work/energy. *J Peasant Stud* 45:237–279 . <https://doi.org/10.1080/03066150.2016.1272587>
- Moquet L, Laurent E, Bacchetta R, Jacquemart A-L (2018) Conservation of hoverflies (Diptera, Syrphidae) requires complementary resources at the landscape and local scales. *Insect Conserv Divers* 11:72–87 . <https://doi.org/10.1111/icad.12245>
- Morandin LA, Kremen C (2013) Hedgerow restoration promotes pollinator populations and exports native bees to adjacent fields. *Ecol Appl* 23:829–839 . <https://doi.org/10.1890/12-1051.1>
- Morandin LA, Long RF, Kremen C (2016) Pest Control and Pollination Cost–Benefit Analysis of Hedgerow Restoration in a Simplified Agricultural Landscape. *J Econ Entomol* 109:1020–1027 .
<https://doi.org/10.1093/jee/tow086>
- Mouquet N, Loreau M (2002) Coexistence in Metacommunities: The Regional Similarity Hypothesis. *Am Nat* 159:420–426 . <https://doi.org/10.1086/338996>
- Mudgal S, Lavel P, Cachia F, Somogyi D, Majewski E, Fontaine L, Bechini L, Debaeke P (2010) Environmental impacts of different crop rotations in the European Union. European Commission - DG ENV, Paris
- Mueller T, Selva N, Pugacewicz E, Prins E (2009) Scale-sensitive landscape complementation determines habitat suitability for a territorial generalist. *Ecography* 32:345–353 .
<https://doi.org/10.1111/j.1600-0587.2008.05694.x>
- Muirhead-Thompson RC (2012) *Trap Responses of Flying Insects: The Influence of Trap Design on Capture Efficiency*. Academic Press
- Navntoft S, Esbjerg P, Riedel W (2006) Effects of reduced pesticide dosages on carabids (Coleoptera: Carabidae) in winter wheat. *Agric For Entomol* 8:57–62 . <https://doi.org/10.1111/j.1461-9555.2006.00282.x>

- Nentwig W, Blick T, Bosmans R, Gloor D, Hänggi A, Kropf C (2017) Spiders of Europe. <https://doi.org/10.24436/1>
- Ng K, Barton PS, Blanchard W, Evans MJ, Lindenmayer DB, Macfadyen S, McIntyre S, Driscoll DA (2018) Disentangling the effects of farmland use, habitat edges, and vegetation structure on ground beetle morphological traits. *Oecologia* 188:645–657 . <https://doi.org/10.1007/s00442-018-4180-9>
- Nieto DJ, Shennan C, Settle WH, O'malley R, Bros S, Honda JY (2006) How Natural Enemies and Cabbage Aphid (*Brevicoryne brassicae* L.) Population Dynamics Affect Organic Broccoli Harvest. *Environ Entomol* 35:94–101 . <https://doi.org/10.1603/0046-225X-35.1.94>
- Nyffeler M, Sunderland KD (2003) Composition, abundance and pest control potential of spider communities in agroecosystems: a comparison of European and US studies. *Agric Ecosyst Environ* 95:579–612 . [https://doi.org/10.1016/S0167-8809\(02\)00181-0](https://doi.org/10.1016/S0167-8809(02)00181-0)
- Oberholzer F, Frank T (2003) Predation by the Carabid Beetles *Pterostichus melanarius* and *Poecilus cupreus* on Slugs and Slug Eggs. *Biocontrol Sci Technol* 13:99–110 . <https://doi.org/10.1080/0958315021000054421>
- Ollerton J (2017) Pollinator Diversity: Distribution, Ecological Function, and Conservation. *Annu Rev Ecol Syst* 48:353–376 . <https://doi.org/10.1146/annurev-ecolsys-110316-022919>
- O'Rourke ME, Liebman M, Rice ME (2008) Ground Beetle (Coleoptera: Carabidae) Assemblages in Conventional and Diversified Crop Rotation Systems. *Environ Entomol* 37:121–130 . [https://doi.org/10.1603/0046-225X\(2008\)37\[121:GBCCAI\]2.0.CO;2](https://doi.org/10.1603/0046-225X(2008)37[121:GBCCAI]2.0.CO;2)
- Östman Ö, Ekblom B, Bengtsson J (2001a) Landscape heterogeneity and farming practice influence biological control. *Basic Appl Ecol* 2:365–371 . <https://doi.org/10.1078/1439-1791-00072>
- Östman O, Ekblom B, Bengtsson J, Weibull A-C (2001b) Landscape complexity and farming practice influence the condition of polyphagous carabid beetles. *Ecol Appl* 11:480–488 . [https://doi.org/10.1890/1051-0761\(2001\)011\[0480:LCAFPI\]2.0.CO;2](https://doi.org/10.1890/1051-0761(2001)011[0480:LCAFPI]2.0.CO;2)
- Ostrom E (2015) *Governing the Commons: The Evolution of Institutions for Collective Action*, Reissue. Cambridge University Press, Cambridge, United Kingdom
- Ostrom E (2012) *The Future of the Commons: Beyond Market Failure and Government Regulations*. Institute of Economic Affairs, London
- Ostrom E (2008) The Challenge of Common-Pool Resources. *Environ Sci Policy Sustain Dev* 50:8–21 . <https://doi.org/10.3200/ENVT.50.4.8-21>
- Ostrom E, Hess C (2007) *Private and Common Property Rights*. Social Science Research Network, Rochester, NY
- Pakeman RJ, Stockan JA (2014) Drivers of carabid functional diversity: abiotic environment, plant functional traits, or plant functional diversity? *Ecology* 95:1213–1224 . <https://doi.org/10.1890/13-1059.1>
- Pausas JG, Verdú M (2010) The Jungle of Methods for Evaluating Phenotypic and Phylogenetic Structure of Communities. *BioScience* 60:614–625 . <https://doi.org/10.1525/bio.2010.60.8.7>

- Pecheur E, Piqueray J, Monty A, Dufrêne M, Mahy G (2020) The influence of ecological infrastructures adjacent to crops on their carabid assemblages in intensive agroecosystems. *PeerJ* 8:20 . <https://doi.org/10.7717/peerj.8094>
- Pedley SM, Dolman PM (2014) Multi-taxa trait and functional responses to physical disturbance. *J Anim Ecol* 83:1542–1552 . <https://doi.org/10.1111/1365-2656.12249>
- Peeters A (2012) Past and future of European grasslands. The challenge of the CAP towards 2020. In: *Grassland Science in Europe*. European Union, Brussels, pp 7–22
- Peres S (2016) Saving the gene pool for the future: Seed banks as archives. *Stud Hist Philos Sci Part C Stud Hist Philos Biol Biomed Sci* 55:96–104 . <https://doi.org/10.1016/j.shpsc.2015.09.002>
- Perfecto I, Vandermeer J, Levins R (2010) The agroecological matrix as alternative to the land-sparing/agriculture intensification model. *Proc Natl Acad Sci U S A* 107:5786–5791
- Perović D, Gámez-Virués S, Börschig C, Klein A-M, Krauss J, Steckel J, Rothenwöhrer C, Erasmi S, Tschardt T, Westphal C (2015) Configurational landscape heterogeneity shapes functional community composition of grassland butterflies. *J Appl Ecol* 52:505–513 . <https://doi.org/10.1111/1365-2664.12394>
- Petersen MK (1999) The timing of dispersal of the predatory beetles *Bembidion lampros* and *Tachyporus hypnorum* from hibernating sites into arable fields. *Entomol Exp Appl* 90:221–224 . <https://doi.org/10.1046/j.1570-7458.1999.00442.x>
- Petit S, Trichard A, Biju-Duval L, McLaughlin ÓB, Bohan DA (2017) Interactions between conservation agricultural practice and landscape composition promote weed seed predation by invertebrates. *Agric Ecosyst Environ* 240:45–53 . <https://doi.org/10.1016/j.agee.2017.02.014>
- Peyraud J-L, Peeters A, De Vliegheer A (2012) Place et atouts des prairies permanentes en France et en Europe. *Fourrages* 195–204
- Pfiffner L, Luka H (2003) Effects of low-input farming systems on carabids and epigeal spiders – a paired farm approach. *Basic Appl Ecol* 4:117–127 . <https://doi.org/10.1078/1439-1791-00121>
- Pfiffner L, Luka H (2000) Overwintering of arthropods in soils of arable fields and adjacent semi-natural habitats. *Agric Ecosyst Environ* 78:215–222 . [https://doi.org/10.1016/S0167-8809\(99\)00130-9](https://doi.org/10.1016/S0167-8809(99)00130-9)
- Philippe M-A, Polombo N (2009) Soixante années de remembrement
- Pimm SL, Jenkins CN, Abell R, Brooks TM, Gittleman JL, Joppa LN, Raven PH, Roberts CM, Sexton JO (2014) The biodiversity of species and their rates of extinction, distribution, and protection. *Science* 344: . <https://doi.org/10.1126/science.1246752>
- Pittaluga P (2013) Landscape as a “Common”: Collective Protection and Management. In: Serreli S (ed) *City Project and Public Space*. Springer Netherlands, Dordrecht, pp 179–195
- Plantureux S, Michaud A, Baumont R (2012) Influence of pedoclimatic and management factors on botanical and functional composition of grasslands. *Polish Grassland Soc-Polskie Towarzystwo Lakarskie*, Poznan
- Pointereau P (2002) Les haies : évolution du linéaire en France depuis quarante ans. *Courr Environ INRA* 46:69–73

- Pointereau P, Bisault L (2006) Trente ans de paysages agricoles - La monoculture et ses dangers pour l'environnement. *Solagro* 4
- Power AG (2010) Ecosystem services and agriculture: tradeoffs and synergies. *Philos Trans R Soc B Biol Sci* 365:2959–2971 . <https://doi.org/10.1098/rstb.2010.0143>
- Power JF, Follett RF (1987) Monoculture. *Sci Am* 256:78–87
- Prasad RP, Snyder WE (2006) Polyphagy complicates conservation biological control that targets generalist predators. *J Appl Ecol* 43:343–352 . <https://doi.org/10.1111/j.1365-2664.2006.01129.x>
- Prasad RP, Snyder WE (2004) Predator interference limits fly egg biological control by a guild of ground-active beetles. *Biol Control* 31:428–437 . <https://doi.org/10.1016/j.biocontrol.2004.07.005>
- Purtauf T, Roschewitz I, Dauber J, Thies C, Tscharrntke T, Wolters V (2005) Landscape context of organic and conventional farms: Influences on carabid beetle diversity. *Agric Ecosyst Environ* 108:165–174 . <https://doi.org/10.1016/j.agee.2005.01.005>
- Ramsden MW, Menéndez R, Leather SR, Wäckers F (2015) Optimizing field margins for biocontrol services: The relative role of aphid abundance, annual floral resources, and overwinter habitat in enhancing aphid natural enemies. *Agric Ecosyst Environ* 199:94–104 . <https://doi.org/10.1016/j.agee.2014.08.024>
- Ray DK, Ramankutty N, Mueller ND, West PC, Foley JA (2012) Recent patterns of crop yield growth and stagnation. *Nat Commun* 3:1293 . <https://doi.org/10.1038/ncomms2296>
- Ribera I, Dolédec S, Downie IS, Foster GN (2001) Effect of Land Disturbance and Stress on Species Traits of Ground Beetle Assemblages. *Ecology* 82:1112–1129 . [https://doi.org/10.1890/0012-9658\(2001\)082\[1112:EOLDAS\]2.0.CO;2](https://doi.org/10.1890/0012-9658(2001)082[1112:EOLDAS]2.0.CO;2)
- Robertson GP, Swinton SM (2005) Reconciling agricultural productivity and environmental integrity: a grand challenge for agriculture. *Front Ecol Environ* 3:38–46 . [https://doi.org/10.1890/1540-9295\(2005\)003\[0038:RAPAEI\]2.0.CO;2](https://doi.org/10.1890/1540-9295(2005)003[0038:RAPAEI]2.0.CO;2)
- Robinson RA, Sutherland WJ (2002) Post-war changes in arable farming and biodiversity in Great Britain. *J Appl Ecol* 39:157–176 . <https://doi.org/10.1046/j.1365-2664.2002.00695.x>
- Römermann C, Bernhardt-Römermann M, Kleyer M, Poschlod P (2009) Substitutes for grazing in semi-natural grasslands – do mowing or mulching represent valuable alternatives to maintain vegetation structure? *J Veg Sci* 20:1086–1098 . <https://doi.org/10.1111/j.1654-1103.2009.01106.x>
- Rosa-Schleich J, Loos J, Mußhoff O, Tscharrntke T (2019) Ecological-economic trade-offs of Diversified Farming Systems – A review. *Ecol Econ* 160:251–263 . <https://doi.org/10.1016/j.ecolecon.2019.03.002>
- Rouabah A (2015) Effets de la gestion des bandes enherbées sur le contrôle biologique des ravageurs de cultures: rôle de la diversité fonctionnelle des carabes (Coleoptera - Carabidae) et de la structure végétale. PhD thesis, Université de Lorraine

- Roume A (2011) Quelle est la contribution des milieux semi-naturels à la diversité et la répartition des assemblages de Carabidae circulants et hivernants dans un paysage rural tempéré ? PhD thesis, Université de Toulouse
- Roume A, Ouin A, Raison L, Deconchat M (2011) Abundance and species richness of overwintering ground beetles (Coleoptera: Carabidae) are higher in the edge than in the centre of a woodlot. *Eur J Entomol* 108:615–622 . <https://doi.org/10.14411/eje.2011.080>
- Roussel V, Leisova L, Exbrayat F, Stehno Z, Balfourier F (2005) SSR allelic diversity changes in 480 European bread wheat varieties released from 1840 to 2000. *Theor Appl Genet* 111:162–170 . <https://doi.org/10.1007/s00122-005-2014-8>
- Rundlöf M, Nilsson H, Smith HG (2008) Interacting effects of farming practice and landscape context on bumble bees. *Biol Conserv* 141:417–426 . <https://doi.org/10.1016/j.biocon.2007.10.011>
- Rundlöf M, Smith HG (2006) The effect of organic farming on butterfly diversity depends on landscape context. *J Appl Ecol* 43:1121–1127 . <https://doi.org/10.1111/j.1365-2664.2006.01233.x>
- Rusch A, Bommarco R, Chiverton P, Öberg S, Wallin H, Wiktelius S, Ekbohm B (2013a) Response of ground beetle (Coleoptera, Carabidae) communities to changes in agricultural policies in Sweden over two decades. *Agric Ecosyst Environ* 176:63–69 . <https://doi.org/10.1016/j.agee.2013.05.014>
- Rusch A, Bommarco R, Jonsson M, Smith HG, Ekbohm B (2013b) Flow and stability of natural pest control services depend on complexity and crop rotation at the landscape scale. *J Appl Ecol* 50:345–354 . <https://doi.org/10.1111/1365-2664.12055>
- Sadeghi H, Gilbert F (2000) Aphid suitability and its relationship to oviposition preference in predatory hoverflies. *J Anim Ecol* 69:771–784 . <https://doi.org/10.1046/j.1365-2656.2000.00433.x>
- Sánchez-Bayo F, Wyckhuys KAG (2019) Worldwide decline of the entomofauna: A review of its drivers. *Biol Conserv* 232:8–27 . <https://doi.org/10.1016/j.biocon.2019.01.020>
- Sandhu HS, Wratten SD, Cullen R (2010) Organic agriculture and ecosystem services. *Environ Sci Policy* 13:1–7 . <https://doi.org/10.1016/j.envsci.2009.11.002>
- Sardiñas HS, Kremen C (2015) Pollination services from field-scale agricultural diversification may be context-dependent. *Agric Ecosyst Environ* 207:17–25 . <https://doi.org/10.1016/j.agee.2015.03.020>
- Schaffers AP, Raemakers IP, Sýkora KV, Braak CJF ter (2008) Arthropod Assemblages Are Best Predicted by Plant Species Composition. *Ecology* 89:782–794 . <https://doi.org/10.1890/07-0361.1>
- Schellhorn NA, Bianchi FJJA, Hsu CL (2014) Movement of Entomophagous Arthropods in Agricultural Landscapes: Links to Pest Suppression. *Annu Rev Entomol* 59:559–581 . <https://doi.org/10.1146/annurev-ento-011613-161952>
- Schellhorn NA, Gagic V, Bommarco R (2015) Time will tell: resource continuity bolsters ecosystem services. *Trends Ecol Evol* 30:524–530 . <https://doi.org/10.1016/j.tree.2015.06.007>
- Schirmel J, Mantilla-Contreras J, Gauger D, Blindow I (2015) Carabid beetles as indicators for shrub encroachment in dry grasslands. *Ecol Indic* 49:76–82 . <https://doi.org/10.1016/j.ecolind.2014.09.041>

- Schirmel J, Thiele J, Entling MH, Buchholz S (2016) Trait composition and functional diversity of spiders and carabids in linear landscape elements. *Agric Ecosyst Environ* 235:318–328 . <https://doi.org/10.1016/j.agee.2016.10.028>
- Schmidt MH, Lauer A, Purtauf T, Thies C, Schaefer M, Tscharntke T (2003) Relative importance of predators and parasitoids for cereal aphid control. *Proc R Soc B Biol Sci* 270:1905–1909 . <https://doi.org/10.1098/rspb.2003.2469>
- Schmidt MH, Roschewitz I, Thies C, Tscharntke T (2005a) Differential effects of landscape and management on diversity and density of ground-dwelling farmland spiders. *J Appl Ecol* 42:281–287 . <https://doi.org/10.1111/j.1365-2664.2005.01014.x>
- Schmidt MH, Roschewitz I, Thies C, Tscharntke T, Nentwig W (2005b) Spiders in space: how landscape-wide movement of generalist predators influences local density, species richness, and biocontrol. *Second Int Symp Biol Control Arthropods Davos Switz 12-16 Sept 2005* 448–452
- Schmidt MH, Thies C, Nentwig W, Tscharntke T (2008) Contrasting responses of arable spiders to the landscape matrix at different spatial scales. *J Biogeogr* 35:157–166 . <https://doi.org/10.1111/j.1365-2699.2007.01774.x>
- Schmidt MH, Tscharntke T (2005a) The role of perennial habitats for Central European farmland spiders. *Agric Ecosyst Environ* 105:235–242 . <https://doi.org/10.1016/j.agee.2004.03.009>
- Schmidt MH, Tscharntke T (2005b) Landscape context of sheetweb spider (Araneae: Linyphiidae) abundance in cereal fields. *J Biogeogr* 32:467–473 . <https://doi.org/10.1111/j.1365-2699.2004.01244.x>
- Schneider G, Krauss J, Boetzi FA, Fritze M-A, Steffan-Dewenter I (2016) Spillover from adjacent crop and forest habitats shapes carabid beetle assemblages in fragmented semi-natural grasslands. *Oecologia* 182:1141–1150 . <https://doi.org/10.1007/s00442-016-3710-6>
- Schneider G, Krauss J, Steffan-Dewenter I (2013) Predation rates on semi-natural grasslands depend on adjacent habitat type. *Basic Appl Ecol* 14:614–621 . <https://doi.org/10.1016/j.baae.2013.08.008>
- Schweiger O, Maelfait JP, Wingerden WV, Hendrickx F, Billeter R, Speelmans M, Augenstein I, Aukema B, Aviron S, Bailey D, Bukacek R, Burel F, Diekötter T, Dirksen J, Frenzel M, Herzog F, Liira J, Roubalova M, Bugter R (2005) Quantifying the impact of environmental factors on arthropod communities in agricultural landscapes across organizational levels and spatial scales. *J Appl Ecol* 42:1129–1139 . <https://doi.org/10.1111/j.1365-2664.2005.01085.x>
- Shearin AF, Reberg-Horton SC, Gallandt ER (2007) Direct Effects of Tillage on the Activity Density of Ground Beetle (Coleoptera: Carabidae) Weed Seed Predators. *Environ Entomol* 36:1140–1146 . [https://doi.org/10.1603/0046-225X\(2007\)36\[1140:DEOTOT\]2.0.CO;2](https://doi.org/10.1603/0046-225X(2007)36[1140:DEOTOT]2.0.CO;2)
- Sirami C, Gross N, Baillod AB, Bertrand C, Carrié R, Hass A, Henckel L, Miguet P, Vuillot C, Alignier A, Girard J, Batáry P, Clough Y, Violle C, Giralt D, Bota G, Badenhauer I, Lefebvre G, Gauffre B, Vialatte A, Calatayud F, Gil-Tena A, Tischendorf L, Mitchell S, Lindsay K, Georges R, Hilaire S, Recasens J, Solé-Senan XO, Robleño I, Bosch J, Barrientos JA, Ricarte A, Marcos-García MÁ, Miñano J, Mathevet R, Gibon A, Baudry J, Balent G, Poulin B, Burel F, Tscharntke T, Bretagnolle V, Siriwardena G, Ouin A, Brotons L, Martin J-L, Fahrig L (2019) Increasing crop heterogeneity enhances multitrophic diversity across agricultural regions. *Proc Natl Acad Sci* 116:16442–16447 . <https://doi.org/10.1073/pnas.1906419116>

- Smith HG, Dänhardt J, Lindström Å, Rundlöf M (2010) Consequences of organic farming and landscape heterogeneity for species richness and abundance of farmland birds. *Oecologia* 162:1071–1079 . <https://doi.org/10.1007/s00442-010-1588-2>
- Snyder WE, Ives AR (2003) Interactions Between Specialist and Generalist Natural Enemies: Parasitoids, Predators, and Pea Aphid Biocontrol. *Ecology* 84:91–107 . [https://doi.org/10.1890/0012-9658\(2003\)084\[0091:IBSAGN\]2.0.CO;2](https://doi.org/10.1890/0012-9658(2003)084[0091:IBSAGN]2.0.CO;2)
- Snyder WE, Ives AR (2001) Generalist Predators Disrupt Biological Control by a Specialist Parasitoid. *Ecology* 82:705–716 . [https://doi.org/10.1890/0012-9658\(2001\)082\[0705:GPDBC\]2.0.CO;2](https://doi.org/10.1890/0012-9658(2001)082[0705:GPDBC]2.0.CO;2)
- Solé-Senan XO, Juárez-Escario A, Conesa JA, Torra J, Royo-Esnal A, Recasens J (2014) Plant diversity in Mediterranean cereal fields: Unraveling the effect of landscape complexity on rare arable plants. *Agric Ecosyst Environ* 185:221–230 . <https://doi.org/10.1016/j.agee.2014.01.003>
- Steffan-Dewenter I, Münzenberg U, Bürger C, Thies C, Tschardt T (2002) Scale-Dependent Effects of Landscape Context on Three Pollinator Guilds. *Ecology* 83:1421–1432 . [https://doi.org/10.1890/0012-9658\(2002\)083\[1421:SDEOLC\]2.0.CO;2](https://doi.org/10.1890/0012-9658(2002)083[1421:SDEOLC]2.0.CO;2)
- Steffen W, Grinevald J, Crutzen P, McNeill J (2011) The Anthropocene: conceptual and historical perspectives. *Philos Trans R Soc Math Phys Eng Sci* 369:842–867 . <https://doi.org/10.1098/rsta.2010.0327>
- Stoate C, Báldi A, Beja P, Boatman ND, Herzog I, van Doorn A, de Snoo GR, Rakosy L, Ramwell C (2009) Ecological impacts of early 21st century agricultural change in Europe – A review. *J Environ Manage* 91:22–46 . <https://doi.org/10.1016/j.jenvman.2009.07.005>
- Stoate C, Boatman ND, Borralho RJ, Carvalho CR, Snoo GR de, Eden P (2001) Ecological impacts of arable intensification in Europe. *J Environ Manage* 63:337–365 . <https://doi.org/10.1006/jema.2001.0473>
- Straub CS, Finke DL, Snyder WE (2008) Are the conservation of natural enemy biodiversity and biological control compatible goals? *Biol Control* 45:225–237 . <https://doi.org/10.1016/j.biocontrol.2007.05.013>
- Strijker D (2005) Marginal lands in Europe—causes of decline. *Basic Appl Ecol* 6:99–106 . <https://doi.org/10.1016/j.baae.2005.01.001>
- Sunderland K, Samu F (2000) Effects of agricultural diversification on the abundance, distribution, and pest control potential of spiders: a review. *Entomol Exp Appl* 95:1–13 . <https://doi.org/10.1046/j.1570-7458.2000.00635.x>
- Sunderland KD, DeSnoo GR, Dinter A, Hance T, Helenius J, Jepson P, Kromp B, Lys JA, Samu F, Sotherton NW, Toft S, Ulber B (1995) Density estimation for invertebrate predators in agroecosystems. *Arthropod Nat Enemies Arable Land - Density Spat Heterog Dispersal* 133–162
- Sunderland KD, Fraser AM, Dixon AFG (1986) Field and Laboratory Studies on Money Spiders (Linyphiidae) as Predators of Cereal Aphids. *J Appl Ecol* 23:433–447 . <https://doi.org/10.2307/2404027>
- Symonds MRE, Moussalli A (2011) A brief guide to model selection, multimodel inference and model averaging in behavioural ecology using Akaike's information criterion. *Behav Ecol Sociobiol* 65:13–21 . <https://doi.org/10.1007/s00265-010-1037-6>

- Symondson WOC, Sunderland KD, Greenstone MH (2002) Can generalist predators be effective biocontrol agents? *Annu Rev Entomol* 47:561–594 . <https://doi.org/10.1146/annurev.ento.47.091201.145240>
- Taugourdeau S, Schneider M, Domenicone C, Sempe L, Amiaud B, Huguenin-Elie O, Plantureux S (2012) Functional diversity-area relationship in permanent grassland. *Polish Grassland Soc-Polskie Towarzystwo Lakarskie, Poznan*
- Thiele HU (1977) *Carabid Beetles in Their Environments: A Study on Habitat Selection by Adaptations in Physiology and Behaviour*, 2012th edn. Springer Science & Business Media, Berlin
- Thies C, Haenke S, Scherber C, Bengtsson J, Bommarco R, Clement LW, Ceryngier P, Dennis C, Emmerson M, Gagic V, Hawro V, Liira J, Weisser WW, Winqvist C, Tscharntke T (2011) The relationship between agricultural intensification and biological control: experimental tests across Europe. *Ecol Appl* 21:2187–2196 . <https://doi.org/10.1890/10-0929.1>
- Thies C, Tscharntke T (1999) Landscape Structure and Biological Control in Agroecosystems. *Science* 285:893–895 . <https://doi.org/10.1126/science.285.5429.893>
- Thomas CFG, Cooke H, Baully J, Marshall EJP (1994) Invertebrate colonisation of overwintering sites in different field boundary habitats. *Asp Appl Biol* 40:229–232
- Thomas CFG, Marshall EJP (1999) Arthropod abundance and diversity in differently vegetated margins of arable fields. *Agric Ecosyst Environ* 72:131–144 . [https://doi.org/10.1016/S0167-8809\(98\)00169-8](https://doi.org/10.1016/S0167-8809(98)00169-8)
- Thomas CFG, Parkinson L, Griffiths GJK, Garcia AF, Marshall EJP (2001) Aggregation and temporal stability of carabid beetle distributions in field and hedgerow habitats. *J Appl Ecol* 38:100–116
- Thorbek P, Bilde T (2004) Reduced numbers of generalist arthropod predators after crop management. *J Appl Ecol* 41:526–538 . <https://doi.org/10.1111/j.0021-8901.2004.00913.x>
- Tilman D (1982) *Resource Competition and Community Structure*. Princeton University Press
- Tilman D, Downing JA (1994) Biodiversity and stability in grasslands. *Nature* 367:363–365 . <https://doi.org/10.1038/367363a0>
- Trichard A, Alignier A, Biju-Duval L, Petit S (2013) The relative effects of local management and landscape context on weed seed predation and carabid functional groups. *Basic Appl Ecol* 14:235–245 . <https://doi.org/10.1016/j.baae.2013.02.002>
- Tscharntke T, Bommarco R, Clough Y, Crist TO, Kleijn D, Rand TA, Tylianakis JM, Nouhuys S van, Vidal S (2007) Conservation biological control and enemy diversity on a landscape scale. *Biol Control* 43:294–309 . <https://doi.org/10.1016/j.biocontrol.2007.08.006>
- Tscharntke T, Clough Y, Wanger TC, Jackson L, Motzke I, Perfecto I, Vandermeer J, Whitbread A (2012a) Global food security, biodiversity conservation and the future of agricultural intensification. *Biol Conserv* 151:53–59 . <https://doi.org/10.1016/j.biocon.2012.01.068>
- Tscharntke T, Klein AM, Kruess A, Steffan-Dewenter I, Thies C (2005a) Landscape perspectives on agricultural intensification and biodiversity – ecosystem service management. *Ecol Lett* 8:857–874 . <https://doi.org/10.1111/j.1461-0248.2005.00782.x>

- Tscharntke T, Rand TA, Bianchi FJJA (2005b) The landscape context of trophic interactions: insect spillover across the crop–noncrop interface. *Ann Zool Fenn* 42:421–432
- Tscharntke T, Steffan-Dewenter I, Kruess A, Thies C (2002) Contribution of Small Habitat Fragments to Conservation of Insect Communities of Grassland–Cropland Landscapes. *Ecol Appl* 12:354–363 . [https://doi.org/10.1890/1051-0761\(2002\)012\[0354:COSHFT\]2.0.CO;2](https://doi.org/10.1890/1051-0761(2002)012[0354:COSHFT]2.0.CO;2)
- Tscharntke T, Tylianakis JM, Rand TA, Didham RK, Fahrig L, Batáry P, Bengtsson J, Clough Y, Crist TO, Dormann CF, Ewers RM, Fründ J, Holt RD, Holzschuh A, Klein AM, Kleijn D, Kremen C, Landis DA, Laurance W, Lindenmayer D, Scherber C, Sodhi N, Steffan-Dewenter I, Thies C, Putten WH van der, Westphal C (2012b) Landscape moderation of biodiversity patterns and processes - eight hypotheses. *Biol Rev* 87:661–685 . <https://doi.org/10.1111/j.1469-185X.2011.00216.x>
- Tschumi M, Albrecht M, Entling MH, Jacot K (2015) High effectiveness of tailored flower strips in reducing pests and crop plant damage. *Proc R Soc B-Biol Sci* 282:189–196 . <https://doi.org/10.1098/rspb.2015.1369>
- Tschumi M, Ekroos J, Hjort C, Smith HG, Birkhofer K (2018) Predation-mediated ecosystem services and disservices in agricultural landscapes. *Ecol Appl* 28:2109–2118 . <https://doi.org/10.1002/eap.1799>
- Tuck SL, Winqvist C, Mota F, Ahnstrom J, Turnbull LA, Bengtsson J (2014) Land-use intensity and the effects of organic farming on biodiversity: a hierarchical meta-analysis. *J Appl Ecol* 51:746–755 . <https://doi.org/10.1111/1365-2664.12219>
- Turner MG, Gardner RH (2015) *Landscape Ecology in Theory and Practice: Pattern and Process*, 2nd edn. Springer-Verlag, New York
- Uetz GW, Halaj J, Cady AB (1999) Guild Structure of Spiders in Major Crops. *J Arachnol* 27:270–280
- van de Wouw M, van Hintum T, Kik C, van Treuren R, Visser B (2010) Genetic diversity trends in twentieth century crop cultivars: a meta analysis. *Theor Appl Genet* 120:1241–1252 . <https://doi.org/10.1007/s00122-009-1252-6>
- van der Sluijs JP, Amaral-Rogers V, Belzunces LP, Bijleveld van Lexmond MFIJ, Bonmatin J-M, Chagnon M, Downs CA, Furlan L, Gibbons DW, Giorio C, Girolami V, Goulson D, Kreutzweiser DP, Krupke C, Liess M, Long E, McField M, Mineau P, Mitchell EAD, Morrissey CA, Noome DA, Pisa L, Settele J, Simon-Delso N, Stark JD, Tapparo A, Van Dyck H, van Praagh J, Whitehorn PR, Wiemers M (2015) Conclusions of the Worldwide Integrated Assessment on the risks of neonicotinoids and fipronil to biodiversity and ecosystem functioning. *Environ Sci Pollut Res* 22:148–154 . <https://doi.org/10.1007/s11356-014-3229-5>
- Vician V, Svitok M, Kočík K, Stašiov S (2015) The influence of agricultural management on the structure of ground beetle (Coleoptera: Carabidae) assemblages. *Biologia (Bratisl)* 70:240–251 . <https://doi.org/10.1515/biolog-2015-0028>
- Villeneuve-Chasset J (2017) *Biodiversité fonctionnelle : protection des cultures et auxiliaires sauvages*, France Agricole. France Agricole
- Wäckers FL, Rijn PCJ van, Bruin J (2005) *Plant-Provided Food for Carnivorous Insects: A Protective Mutualism and its Applications*. Cambridge University Press

- Wamser S, Diekötter T, Boldt L, Wolters V, Dauber J (2012) Trait-specific effects of habitat isolation on carabid species richness and community composition in managed grasslands. *Insect Conserv Divers* 5:9–18 . <https://doi.org/10.1111/j.1752-4598.2010.00110.x>
- Weibull A-C, Bengtsson J, Nohlgren E (2000) Diversity of butterflies in the agricultural landscape: the role of farming system and landscape heterogeneity. *Ecography* 23:743–750 . <https://doi.org/10.1111/j.1600-0587.2000.tb00317.x>
- Weibull A-C, Östman Ö, Granqvist Å (2003) Species richness in agroecosystems: the effect of landscape, habitat and farm management. *Biodivers Conserv* 12:1335–1355 . <https://doi.org/10.1023/A:1023617117780>
- Wezel A, Casagrande M, Celette F, Vian J-F, Ferrer A, Peigné J (2014) Agroecological practices for sustainable agriculture. A review. *Agron Sustain Dev* 34:1–20 . <https://doi.org/10.1007/s13593-013-0180-7>
- Whittaker RH (1972) Evolution and Measurement of Species Diversity. *Taxon* 21:213–251 . <https://doi.org/10.2307/1218190>
- Wiens JA (2002) Central Concepts and Issues of Landscape Ecology. In: Gutzwiller KJ (ed) *Applying Landscape Ecology in Biological Conservation*. Springer New York, pp 3–21
- Wiens JA, Stenseth NChr, Van Horne B, Ims RA (1993) Ecological Mechanisms and Landscape Ecology. *Oikos* 66:369–380 . <https://doi.org/10.2307/3544931>
- Wilkening AJ, Foltz JL, Atkinson TH, Connor MD (1981) AN OMNIDIRECTIONAL FLIGHT TRAP FOR ASCENDING AND DESCENDING INSECTS1. *Can Entomol* 113:453–455 . <https://doi.org/10.4039/Ent113453-5>
- Willi JC, Mountford JO, Sparks TH (2005) The Modification of Ancient Woodland Ground Flora at Arable Edges. *Biodivers Conserv* 14:3215–3233 . <https://doi.org/10.1007/s10531-004-0443-3>
- Winfrey R, Gross BJ, Kremen C (2011) Valuing pollination services to agriculture. *Ecol Econ* 71:80–88 . <https://doi.org/10.1016/j.ecolecon.2011.08.001>
- Winqvist C, Bengtsson J, Aavik T, Berendse F, Clement LW, Eggers S, Fischer C, Flohre A, Geiger F, Liira J, Pärt T, Thies C, Tscharntke T, Weisser WW, Bommarco R (2011) Mixed effects of organic farming and landscape complexity on farmland biodiversity and biological control potential across Europe. *J Appl Ecol* 48:570–579 . <https://doi.org/10.1111/j.1365-2664.2010.01950.x>
- Winqvist C, Bengtsson J, Öckinger E, Aavik T, Berendse F, Clement LW, Fischer C, Flohre A, Geiger F, Liira J, Thies C, Tscharntke T, Weisser WW, Bommarco R (2014) Species' traits influence ground beetle responses to farm and landscape level agricultural intensification in Europe. *J Insect Conserv* 18:837–846 . <https://doi.org/10.1007/s10841-014-9690-0>
- Wise DH (1995) *Spiders in Ecological Webs*. Cambridge University Press
- Wissinger SA (1997) Cyclic Colonization in Predictably Ephemeral Habitats: A Template for Biological Control in Annual Crop Systems. *Biol Control* 10:4–15 . <https://doi.org/10.1006/bcon.1997.0543>

Woodcock BA, Bullock JM, McCracken M, Chapman RE, Ball SL, Edwards ME, Nowakowski M, Pywell RF (2016) Spill-over of pest control and pollination services into arable crops. *Agric Ecosyst Environ* 231:15–23 . <https://doi.org/10.1016/j.agee.2016.06.023>

Zalasiewicz J, Williams M, Steffen W, Crutzen P (2010) The New World of the Anthropocene. *Environ Sci Technol* 44:2228–2231 . <https://doi.org/10.1021/es903118j>

Appendices

Table of contents

Appendix A	169
Appendix B	170
Appendix C.....	171
Appendix D	172
Appendix E.....	175
Appendix F.....	176
Appendix G	177
Appendix H	178
Appendix I.....	180
Appendix J	181
Appendix K.....	182

Appendix A

Land cover types accounted for the landscape Shannon diversity index

Land cover type
Winter cereal
Maize
Rapeseed
Sunflower
Soybean
Permanent grassland
Temporary grassland
Orchard
Vineyard
Fallow
Other leguminous and oleaginous crop
Other crops: market gardening, horticulture etc.
Woodland

Appendix B

Set of explanatory variables to study species richness, activity-density and evenness of carabids in cereal or grassland land covers from generalized linear models comparison:

B.1 explanatory parameters and B.2 random parameters.

B.1

Variable	Abbreviation	Type	Values / Metric
Land cover type	type	Qualitative	Winter cereal crop (WC) / Permanent grassland (PG)
Field size	size	Continuous	Hectares (ha)
Complexity shape index	shape	Continuous	Double

B.2

Variable	Abbreviation	Type	Values / Metric
Study region	region	Qualitative	Rovaltain (R) / Bièvre (B) / Forez (F)
Year of sampling	type	Qualitative	2017 / 2018
Sample pair site	site	Qualitative	Pair nomenclature

Appendix C

Null model ΔAIC_c for every multimodel inference

for 3. Complementarity of grasslands and cereal fields ensures carabid regional diversity
in French farmlands

Model	Null model ΔAIC_c	Number of models retained for averaging
Species richness	31.72	4
Activity-density	104.07	4
Evenness	32.76	1

Appendix D

Full list of sampled carabid species and their functional life traits

Genus species	Diet	Wing status	Mean body size (mm)
<i>Acinopus picipes</i>	phytophagous	apterous	14.5
<i>Acupalpus meridianus</i>	polyphagous	macropterous	3.75
<i>Agonum hypocrita</i>	predatory	macropterous	8
<i>Agonum muelleri</i>	predatory	macropterous	7.5
<i>Amara aenea</i>	phytophagous	macropterous	7.25
<i>Amara anthobia</i>	phytophagous	macropterous	6
<i>Amara communis</i>	phytophagous	macropterous	6.5
<i>Amara consularis</i>	phytophagous	macropterous	8
<i>Amara familiaris</i>	phytophagous	macropterous	6
<i>Amara fulvipes</i>	phytophagous	macropterous	10.5
<i>Amara kulti</i>	phytophagous	macropterous	9.25
<i>Amara lucida</i>	phytophagous	macropterous	5.25
<i>Amara lunicollis</i>	phytophagous	macropterous	7.5
<i>Amara montivaga</i>	phytophagous	macropterous	7.5
<i>Amara ovata</i>	phytophagous	macropterous	9
<i>Amara plebeja</i>	phytophagous	macropterous	6.75
<i>Amara similata</i>	phytophagous	macropterous	8.5
<i>Amara strenua</i>	phytophagous	macropterous	9.25
<i>Amara tibialis</i>	phytophagous	macropterous	4.5
<i>Amara tricuspidata</i>	phytophagous	macropterous	8
<i>Anchomenus dorsalis</i>	predatory	macropterous	7
<i>Anisodactylus binotatus</i>	polyphagous	macropterous	10.5
<i>Anisodactylus nemorivagus</i>	polyphagous	macropterous	8
<i>Anisodactylus signatus</i>	polyphagous	macropterous	12.5
<i>Asaphidion stierlini</i>	predatory	macropterous	4.25
<i>Badister bullatus</i>	predatory	macropterous	5.5
<i>Brachinus crepitans</i>	predatory	macropterous	8.5
<i>Brachinus elegans</i>	predatory	macropterous	7.75
<i>Brachinus explodens</i>	predatory	macropterous	6.5
<i>Brachinus sclopeta</i>	predatory	macropterous	5.75
<i>Calathus fuscipes</i>	predatory	apterous	12.5
<i>Calathus melanocephalus</i>	predatory	dimorphic	7
<i>Callistus lunatus</i>	predatory	macropterous	6.5
<i>Carabus auratus</i>	predatory	apterous	23.5
<i>Carabus cancellatus</i>	predatory	apterous	26.5
<i>Carabus coriaceus</i>	predatory	apterous	37
<i>Carabus monilis</i>	predatory	apterous	27
<i>Carabus violaceus</i>	predatory	apterous	27
<i>Chlaeniellus nigricornis</i>	predatory	macropterous	11
<i>Chlaeniellus nitidulus</i>	predatory	macropterous	11
<i>Clivina fossor</i>	predatory	macropterous	6

Genus species	Diet	Wing status	Mean body size (mm)
<i>Cylindera germanica</i>	predatory	macropterous	9.5
<i>Demetrius atricapillus</i>	predatory	macropterous	5
<i>Diachromus germanus</i>	phytophagous	macropterous	9
<i>Dinodes decipiens</i>	predatory	macropterous	11.5
<i>Dixus clypeatus</i>	phytophagous	macropterous	9.5
<i>Gynandromorphus etruscus</i>	phytophagous	macropterous	10.5
<i>Harpalus affinis</i>	polyphagous	macropterous	10.5
<i>Harpalus albanicus</i>	phytophagous	macropterous	8.5
<i>Harpalus anxius</i>	phytophagous	macropterous	7.25
<i>Harpalus atratus</i>	phytophagous	macropterous	12.5
<i>Harpalus dimidiatus</i>	phytophagous	macropterous	12.5
<i>Harpalus distinguendus</i>	phytophagous	macropterous	10
<i>Harpalus honestus</i>	phytophagous	dimorphic	8.5
<i>Harpalus luteicornis</i>	phytophagous	macropterous	6.75
<i>Harpalus oblitus</i>	phytophagous	macropterous	10.5
<i>Harpalus pumilus</i>	phytophagous	dimorphic	5.5
<i>Harpalus pygmaeus</i>	phytophagous	macropterous	6.25
<i>Harpalus rubripes</i>	phytophagous	macropterous	9
<i>Harpalus serripes</i>	phytophagous	macropterous	11
<i>Harpalus tardus</i>	phytophagous	macropterous	9.5
<i>Leistus ferrugineus</i>	predatory	macropterous	7
<i>Leistus fulvibarbis</i>	predatory	macropterous	7.5
<i>Licinus cassideus</i>	predatory	apterous	14.5
<i>Loricera pilicornis</i>	predatory	macropterous	7.5
<i>Metallina lampros</i>	predatory	dimorphic	3.25
<i>Metallina properans</i>	predatory	dimorphic	3.5
<i>Microlestes gallicus</i>	predatory	apterous	2.9
<i>Microlestes luctuosus</i>	predatory	macropterous	2.4
<i>Microlestes maurus</i>	predatory	apterous	2.4
<i>Microlestes minutulus</i>	predatory	macropterous	3.1
<i>Nebria brevicollis</i>	predatory	macropterous	11.5
<i>Nebria salina</i>	predatory	macropterous	11
<i>Notiophilus biguttatus</i>	predatory	dimorphic	5.25
<i>Notiophilus palustris</i>	predatory	dimorphic	5.25
<i>Notiophilus quadripunctatus</i>	predatory	dimorphic	5.25
<i>Notiophilus substriatus</i>	predatory	dimorphic	5.25
<i>Ocydromus callosus</i>	predatory	dimorphic	3.75
<i>Ocydromus latinus</i>	predatory	macropterous	5.5
<i>Ocydromus tetracolos</i>	predatory	dimorphic	6
<i>Ophonus ardosiacus</i>	phytophagous	macropterous	11.5
<i>Ophonus azureus</i>	phytophagous	dimorphic	8
<i>Ophonus cribricollis</i>	phytophagous	macropterous	8
<i>Ophonus puncticeps</i>	phytophagous	macropterous	7.5
<i>Ophonus sabulicola</i>	phytophagous	macropterous	15
<i>Panagaeus bipustulatus</i>	predatory	macropterous	7.25

Genus species	Diet	Wing status	Mean body size (mm)
<i>Paratachys bistratus</i>	predatory	macropterous	2.15
<i>Parophonus maculicornis</i>	phytophagous	macropterous	6.5
<i>Philochthus lunulatus</i>	predatory	macropterous	3.6
<i>Philorhizus notatus</i>	predatory	dimorphic	2.75
<i>Phyla obtusa</i>	predatory	dimorphic	2.75
<i>Phyla tethys</i>	predatory	macropterous	3.25
<i>Platyderus depressus</i>	predatory	macropterous	6.75
<i>Poecilus cupreus</i>	polyphagous	macropterous	11
<i>Poecilus kugelanni</i>	predatory	macropterous	13
<i>Poecilus sericeus</i>	predatory	macropterous	13
<i>Poecilus versicolor</i>	predatory	macropterous	10
<i>Pseudoophonus rufipes</i>	polyphagous	macropterous	13.5
<i>Pterostichus anthracinus</i>	predatory	macropterous	10.5
<i>Pterostichus madidus</i>	polyphagous	apterous	16.5
<i>Pterostichus melanarius</i>	predatory	dimorphic	16.5
<i>Pterostichus nigrita</i>	predatory	macropterous	10.5
<i>Pterostichus strenuus</i>	predatory	dimorphic	6.25
<i>Pterostichus vernalis</i>	predatory	dimorphic	7
<i>Semiophonus signaticornis</i>	phytophagous	macropterous	6.5
<i>Stenolophus teutonius</i>	polyphagous	macropterous	5.75
<i>Stomis pumicatus</i>	predatory	apterous	6.75
<i>Syntomus foveatus</i>	predatory	apterous	3.25
<i>Syntomus obscuroguttatus</i>	predatory	macropterous	3.25
<i>Syntomus truncatellus</i>	predatory	apterous	3.25
<i>Tachyura parvula</i>	predatory	macropterous	1.9
<i>Trechus obtusus</i>	predatory	dimorphic	3.6
<i>Trechus quadristriatus</i>	predatory	macropterous	3.6

Appendix E

Rank and relative activity-density of the most abundant carabid beetle species
in the 3 study regions of southeastern France.

Sampling size in each study region is Rovaltain (n = 82), Bièvre (n = 65), Forez (n = 59).

Species	All study regions		Rovaltain		Bièvre		Forez	
	Rank	Activity-density (%)	Rank	Activity-density (%)	Rank	Activity-density (%)	Rank	Activity-density (%)
<i>Poecilus cupreus</i>	25	1	17	2	25	2	32	1
<i>Anchomenus dorsalis</i>	19	2	19	1	27	1	10	2
<i>Harpalus dimidiatus</i>	4	3	11	3	5	4	0	37
<i>Metallina lampros</i>	4	4	2	12	1	14	5	5
<i>Amara aenea</i>	3	5	4	6	2	9	2	10
<i>Trechus quadristriatus</i>	3	6	5	5	3	6	2	8
<i>Metallina properans</i>	3	7	1	21	9	3	6	3
<i>Harpalus anxius</i>	3	8	0	40	4	5	1	12
<i>Pterostichus melanarius</i>	3	9	2	10	1	17	1	18
<i>Harpalus affinis</i>	3	10	9	4	1	13	6	4

Appendix F

Summary of general linear mixed models averaging for carabid species richness, activity-density and evenness.

Diversity indicator ^a	Variable ^b	Importance (%)	Relative importance (%)	Multimodel estimate ± SE	z value	p value	signif.
Species richness	(Intercept)			1.992 ± .174	11.46	0.000	***
	Forez	60	100	0.144 ± .101	1.42	0.156	
	Rovaltain	60	100	-0.422 ± .108	3.90	< 0.001	***
	2018	100	100	0.089 ± .097	0.92	0.356	
	field size	60	54	0.013 ± .012	1.09	0.274	
	shape	55	48	-0.169 ± .129	1.31	0.189	
	perm. grassland	60	25	-0.079 ± .130	0.61	0.544	
	2018*perm. grassland	60	25	-0.024 ± .121	0.20	0.841	
	size*perm. grassland	15	6	0.030 ± .021	1.46	0.144	
	perm. grassland*Forez	15	3	0.157 ± .128	1.23	0.219	
	perm. grassland*Rovaltain	15	3	0.174 ± .153	1.13	0.258	
Activity-density	(Intercept)			3.419 ± .323	10.58	0.000	***
	perm. grassland	64	100	-0.500 ± .234	2.14	0.033	*
	field size	64	100	0.033 ± .089	0.38	0.706	
	shape	45	100	-0.317 ± .215	1.48	0.139	
	Forez	64	100	-0.105 ± .212	0.50	0.620	
	Rovaltain	64	100	-0.730 ± .225	3.25	0.001	**
	2018	100	98	0.587 ± .182	3.22	0.001	**
	field size*perm. grassland	18	77	0.238 ± .109	2.18	0.030	*
	perm. grassland*Forez	18	52	0.329 ± .200	1.65	0.099	
	perm. grassland*Rovaltain	18	52	0.436 ± .218	2.00	0.046	*
	2018* perm. grassland	64	50	-0.433 ± .196	2.21	0.027	*
Evenness	(Intercept)			0.773 ± .018	43.82	< 0.001	***
	perm. grassland	62	100	0.125 ± .018	7.01	< 0.001	***
	2018	100	100	-0.037 ± .020	-1.85	0.067	

^a Species richness models were fitted with Poisson distribution errors, activity-density model was fitted with negative binomial distribution errors and evenness with Gaussian distribution errors

^b Default qualitative variables values in intercept are: land cover winter cereal, study region Bièvre and year 2017

Appendix G

Significant Spearman's rank correlations (ρ)
between landscape variables within a 200 m radius around the sampling point
of the three study regions

Landscape variables		ρ	p-value
Rovaltain			
Winter crop-grassland edge density	Grasslands	0.48	**
Winter crop-grassland edge density	Overall edge density	0.32	*
Bièvre			
Winter crop-grassland edge density	Overall edge density	0.40	*
Landscape Shannon index	Overall edge density	0.39	*
Forez			
Landscape Shannon index	Grasslands	-0.55	**

Appendix H

Summary of generalized linear models results
for carabid species richness in H.1 both land cover types, H.2 permanent grasslands,
H.3 winter cereal crops and H.4 common species richness.

^a Default qualitative variables values in intercept are: study region Bièvre and year 2017

H.1

Variable ^a	Estimate ± SE	z value	p value	signif.
Species richness ~ (Shannon + Edge density)*Study region				
(Intercept)	1.895 ± .290	6.53	< 0.001	***
Shannon	0.522 ± .221	2.36	0.018	*
Edge density	-0.053 ± .051	-1.05	0.296	
Study region Forez	1.445 ± .398	3.63	< 0.001	***
Study region Rovaltain	0.419 ± .440	0.95	0.340	
Year 2018	0.026 ± .071	0.36	0.716	
Shannon*Forez	-1.073 ± .313	-3.42	0.001	**
Shannon*Rovaltain	-0.575 ± .329	-1.75	0.081	
Edge density*Forez	0.176 ± .074	2.37	0.018	*
Edge density*Rovaltain	0.190 ± .111	1.72	0.085	

H.2

Variable ^a	Estimate ± SE	z value	p value	signif.
Species richness ~ (Shannon + Edge density)*Study region				
(Intercept)	1.027 ± .420	2.45	0.014	*
Shannon	0.657 ± .338	1.94	0.052	
Edge density	0.049 ± .070	0.69	0.488	
Study region Forez	2.587 ± .523	4.95	< 0.001	***
Study region Rovaltain	0.195 ± .593	0.33	0.743	
Year 2018	0.055 ± .097	0.56	0.573	
Shannon*Forez	-1.968 ± .432	-4.56	< 0.001	***
Shannon*Rovaltain	-0.389 ± .477	-0.82	0.415	
Edge density*Forez	0.118 ± .097	1.23	0.221	
Edge density*Rovaltain	-0.012 ± .136	-0.09	0.931	

H.3

Variable ^a	Estimate ± SE	z value	p value	signif.
Species richness ~ (Shannon + Edge density)*Study region				
(Intercept)	2.113 ± .096	2.20	< 0.001	***
Edge density	-0.080 ± .061	-1.31	0.190	
Study region Forez	-0.029 ± .096	-0.30	0.763	
Study region Rovaltain	-0.466 ± .117	-3.98	< 0.001	***
Year 2018	0.071 ± .090	0.79	0.428	
Edge density*Forez	0.154 ± .092	1.67	0.095	
Edge density*Rovaltain	0.237 ± .126	1.89	0.059	

H.4

Variable ^a	Estimate ± SE	z value	p value	signif.
(Common, Exclusive) ~ (Edge density WG + Grasslands)*Study region				
(Intercept)	-1.718 ± .236	-7.27	36.206	
Grasslands	-0.183 ± .135	-1.35	0.178	
Edge density WG	0.247 ± .107	2.30	0.021	*
Study region Forez	-0.140 ± .226	-0.62	0.535	
Study region Rovaltain	-0.419 ± .258	-1.62	0.104	
Year 2018	0.012 ± .223	0.05	0.959	
Grasslands*Forez	0.299 ± .207	1.45	0.148	
Grasslands*Rovaltain	0.814 ± .299	2.72	0.006	**
Edge density WG*Forez	0.132 ± .214	0.62	0.537	
Edge density WG*Rovaltain	-0.201 ± .260	-0.77	0.440	

Appendix I

Incidence of carabid per wing status, size and diet traits
according to their commonness or exclusiveness to one sampled land cover:
summary of general linear mixed models averaging results.

Model ^a	Variable ^b	Importance (%)	Relative importance (%)	Multimodel estimate \pm SE	z value	p value	signif.
Species commonness and exclusiveness	(Intercept)			-2.92 \pm 0.33	8.86	0.000	***
	wings	57	40	-0.08 \pm 0.09	0.86	0.389	
	polyphagous	57	100	1.22 \pm 0.34	3.60	0.000	***
	predatory	57	100	0.74 \pm 0.29	2.52	0.012	*
	size	64	74	-0.64 \pm 0.40	1.61	0.107	
	year 2018	100	100	0.37 \pm 0.24	1.58	0.115	
	size*wings	21	9	-0.04 \pm 0.13	0.32	0.747	
	polyphagous*size	21	59	0.69 \pm 0.65	1.06	0.289	
	predatory*size	21	59	0.80 \pm 0.32	2.50	0.013	*
Species exclusiveness per land cover type	(Intercept)			-1.45 \pm 0.20	7.33	0.000	***
	wings	57	100	0.42 \pm 0.08	5.49	< 0.001	***
	polyphagous	57	100	1.83 \pm 0.26	7.08	< 0.001	***
	predatory	57	100	2.04 \pm 0.18	11.21	< 0.001	***
	size	64	100	0.17 \pm 0.23	0.75	0.452	
	year 2018	100	100	-0.04 \pm 0.19	0.21	0.835	
	size*wings	21	99	-0.36 \pm 0.11	3.18	0.001	***
	polyphagous*size	21	60	-1.06 \pm 0.56	1.89	0.059	.
	predatory*size	21	60	-0.35 \pm 0.21	1.72	0.086	.

^a Both models were fitted with binomial law distribution.

^b Default qualitative variables values are in intercept: phytophagous and year 2017

Appendix J

Null model ΔAIC_c for every multimodel inference
for 6. Landscape and field parameters, spiders and pollinators.

Model	Null model ΔAIC_c	Number of models retained for averaging
Spider family richness	40.150	1
Spider activity-density	194.356	1
Hoverfly activity-density	79.942	1
Lacewing activity-density	57.894	4

Appendix K

Summary of general linear mixed models averaging results
for K.1 spider family richness and K.2 activity-density, K.3 hoverfly activity-density
and K.4 lacewing activity-density.

K.1

Parameter ^a	Multimodel estimate ± SE	z value	p value	signif.
(intercept)	4.468 ± 0.235	19.027	0.000	
Rovaltain	-0.504 ± 0.221	-2.28	0.025	*
Forez	0.046 ± 0.222	0.21	0.834	
Perm.grassland	1.180 ± 0.167	7.06	< 0.001	***
2018	-0.092 ± 0.196	-0.47	0.639	

^a Default qualitative variables values in intercept are: land cover winter cereal, study region Bièvre and year 2017

K.2

Parameter ^a	Multimodel estimate ± SE	z value	p value	signif.
(Intercept)	3.660 ± 0.106	34.511	0.000	
Grassland coverage	0.002 ± 0.083	0.02	0.984	
Hedgerow coverage	-0.436 ± 0.127	-3.43	< 0.001	***
Landscape Shannon	0.080 ± 0.087	0.92	0.355	
Edge density	-0.172 ± 0.058	-2.96	0.003	**
Forez	-0.384 ± 0.124	-3.09	0.002	**
Rovaltain	-0.503 ± 0.123	-4.08	< 0.001	***
Perm. grassland	0.291 ± 0.022	12.96	< 0.001	***
Field size	0.114 ± 0.024	4.74	< 0.001	***
2018	0.389 ± 0.088	4.44	< 0.001	***
Grassland cover.*Forez	0.108 ± 0.118	0.91	0.361	
Grassland cover.*Rovaltain	0.062 ± 0.126	0.49	0.622	
Hedgerow cover.*Forez	0.294 ± 0.179	1.65	0.099	
Hedgerow cover.*Rovaltain	0.284 ± 0.131	2.16	0.031	*
Landscape Shannon*Forez	-0.271 ± 0.138	-1.96	0.050	*
Landscape Shannon*Rovaltain	-0.046 ± 0.105	-0.44	0.660	
Edge density*Forez	0.211 ± 0.091	2.31	0.021	*
Edge density*Rovaltain	-0.040 ± 0.109	-0.37	0.713	
Grassland cover.*Perm. grassland	0.094 ± 0.031	3.08	0.002	**
Hedgerow cover.*Perm. grassland	0.266 ± 0.030	8.92	< 0.001	***
Landscape Shannon*Perm. grassland	0.194 ± 0.029	6.79	< 0.001	***
Edge density*Perm. grassland	0.064 ± 0.022	2.97	0.003	**
Perm. grassland*Field size	0.002 ± 0.030	0.05	0.958	

^a Default qualitative variables values in intercept are: land cover winter cereal, study region Bièvre and year 2017

K.3

Parameter ^a	Multimodel estimate ± SE	z value	p value	signif.
(Intercept)	-0.880 ± 0.408	-2.157	0.031	
Grassland coverage	-0.965 ± 0.338	-2.85	0.004	**
Edge density	0.260 ± 0.220	1.18	0.237	
Forez	0.851 ± 0.423	2.01	0.045	*
Rovaltain	2.781 ± 0.426	6.53	< 0.001	***
Perm. grassland	-0.747 ± 0.126	-5.92	< 0.001	***
Field size	-0.050 ± 0.094	-0.54	0.590	
2018	0.450 ± 0.290	1.55	0.121	
Grassland cover.*Forez	0.238 ± 0.411	0.58	0.563	
Grassland cover.*Rovaltain	1.243 ± 0.431	2.88	0.004	**
Edge density*Forez	0.198 ± 0.323	0.61	0.540	
Edge density*Rovaltain	0.617 ± 0.339	1.82	0.069	
Grassland cover.*Perm. grassland	0.314 ± 0.148	2.13	0.033	*
Edge density*Perm. grassland	-0.394 ± 0.128	-3.07	0.002	**
Perm. grassland*Field size	-0.445 ± 0.188	-2.37	0.018	*

^a Default qualitative variables values in intercept are: land cover winter cereal, study region Bièvre and year 2017

K.4

Parameter ^a	Importance (%)	Relative importance (%)	Multimodel estimate \pm SE	z value	p value	signif.
(Intercept)			1.322 \pm 0.292	4.526	0.000	
Forez	100	100	-0.393 \pm 0.393	1.00	0.317	
Rovaltain	100	100	0.393 \pm 0.315	1.25	0.212	
Perm. grassland	94	100	-0.676 \pm 0.117	5.77	< 0.001	***
Field size	94	100	0.037 \pm 0.090	0.42	0.677	
2018	100	100	-0.815 \pm 0.243	3.35	< 0.001	***
Grassland coverage	50	95	-0.780 \pm 0.262	2.97	0.003	**
Hedgerow coverage	44	89	-0.647 \pm 0.385	1.68	0.093	
Landscape Shannon	44	49	-0.192 \pm 0.270	0.71	0.476	
Edge density	50	36	-0.155 \pm 0.181	0.85	0.393	
Grassland cover.*Forez	50	95	0.553 \pm 0.426	1.30	0.194	
Grassland cover.*Rovaltain	50	95	0.828 \pm 0.365	2.27	0.023	*
Hedgerow cover.*Forez	44	89	-0.730 \pm 0.673	1.09	0.278	
Hedgerow cover.*Rovaltain	44	89	0.598 \pm 0.397	1.51	0.131	
Landscape Shannon*Forez	44	49	0.887 \pm 0.485	1.83	0.067	
Landscape Shannon*Rovaltain	44	49	0.024 \pm 0.320	0.07	0.940	
Grassland cover.*Perm. grassland	50	95	-0.192 \pm 0.160	1.20	0.230	
Hedgerow cover.*Perm. grassland	50	95	0.144 \pm 0.069	2.10	0.036	*
Landscape Shannon*Perm. grassland	44	49	-0.266 \pm 0.141	1.88	0.060	
Field size*Perm. grassland	94	100	-0.320 \pm 0.148	2.16	0.031	*
Edge density*Forez	50	36	0.455 \pm 0.286	1.59	0.112	
Edge density*Rovaltain	50	36	0.408 \pm 0.299	1.37	0.172	
Edge density*Perm. grassland	50	36	0.177 \pm 0.102	1.74	0.083	

^a Default qualitative variables values in intercept are: land cover winter cereal, study region Bièvre and year 2017

Résumé substantiel en français

Introduction

L'impact mondial de l'être humain sur la biodiversité est de mieux en mieux connu. Il est désormais si considérable que des chercheurs de diverses disciplines ont nommé notre époque Anthropocène (Zalasiewicz et al. 2010; Steffen et al. 2011; Crutzen 2016). En effet, le rythme d'extinction des espèces est aujourd'hui 1 000 fois supérieur à la normale et est largement dû aux activités anthropiques (Pimm et al. 2014; Ceballos et al. 2015). Ce déclin rapide de la biodiversité mondiale constitue potentiellement la sixième extinction de masse (Dirzo et al. 2014; Ceballos and Ehrlich 2018).

L'agriculture industrielle contemporaine contribue à cette menace qui pèse sur la biodiversité (Bianchi et al. 2006; IPBES 2018a). En effet, son intensification depuis les années 50 a amené un changement radical de pratiques, notamment la mécanisation ou l'application systématique de fertilisants minéraux et de pesticides de synthèse (Mazoyer and Roudart 2006). Par ailleurs, l'intensification de l'agriculture a aussi engendré une spécialisation par territoire de production, notamment une différence nette entre zones de grandes cultures et d'élevage.

Ainsi, de cette conjonction d'intensification des pratiques et de spécialisation territoriale a résulté la simplification des paysages agricoles (Robinson and Sutherland 2002; Tschamtkke et al. 2005a; Emmerson et al. 2016). Cette simplification des paysages s'est produite tant sur le plan de l'hétérogénéité configurationnelle, la taille et l'agencement des éléments, que compositionnelle, la diversité des couvertures du sol (Fahrig et al. 2011). De fait, les parcelles agricoles ont été agrandies pour faciliter leur mécanisation (Stoate et al. 2001), ce qui prit en France la forme de politiques de remembrements par vagues successives (Philippe and Polombo 2009). De surcroît, l'intensification de l'agriculture a amené une réduction de la diversité des espèces et variétés cultivées (Roussel et al. 2005; van de Wouw et al. 2010; Peres 2016), et donc la domination de seulement quelques-unes dans les paysages (Ray et al. 2012). Les rotations culturales devinrent plus courtes et moins diversifiées, dont une manifestation extrême est la monoculture.

L'intensification de l'agriculture a engendré la destruction d'éléments naturels et semi-naturels, comme les haies, les bosquets ou même les prairies permanentes. Ces dernières ont en effet connu un net déclin en Europe, où elles ont perdu 30% de la surface qu'elles recouvraient en 1960 (Peyraud et al. 2012). En France, les prairies ont perdu 23% de leur surface de 1970 (Huyghe 2009). Ceci s'explique à la fois par la disparition des activités d'élevage dans certaines régions qui se tournèrent vers les grandes cultures, mais aussi par la généralisation de fourrages culturels, comme le maïs-ensilage.

Pourtant, les habitats non cultivés, et en particulier les prairies permanentes, sont essentiels pour la biodiversité. Cette dernière inclue les auxiliaires de l'agriculture, comme les carabes, les araignées, les syrphes ou les chrysopes (Dauber et al. 2005; Purtauf et al. 2005; Bianchi et al. 2006; Sirami et al. 2019) ainsi que les pollinisateurs (Weibull et al. 2000; Barbaro and Halder 2009). Ces habitats sont ainsi plus stables que les cultures car moins sujets à des perturbations anthropiques dues à l'agriculture. Par ailleurs, ils procurent des proies alternatives pour les espèces auxiliaires et des ressources florales complémentaires aux pollinisateurs. Les milieux non-cultivés peuvent aussi constituer des habitats refuges, lors de perturbations agricoles, ou d'hivernage pour les communautés des cultures (Lee et al. 2001a; Thorbek and Bilde 2004; Schirmel et al. 2016). De surcroît, les prairies permanentes procurent des habitats de haute qualité pour les pollinisateurs, qui peuvent y trouver une ressource florale diversifiée (Steffan-Dewenter et al. 2002; Le Féon et al. 2010).

Une grande diversité d'insectes fournit des services écosystémiques aux activités agricoles, notamment par la prédation des ravageurs ou par la pollinisation des cultures (Altieri 1999; Moonen and Bàrberi 2008; Emmerson et al. 2016). Pourtant, la simplification des paysages par l'intensification de l'agriculture met en péril la biodiversité auxiliaire et donc les services écosystémiques qui en dépendent. Aussi, une plus grande hétérogénéité paysagère, qu'elle soit compositionnelle ou configurationnelle, favorise les services écosystémiques à destination de l'agriculture (Bianchi et al. 2006; Emmerson et al. 2016) ; des travaux ont démontré que le contrôle biologique est favorisé par un paysage agricole plus complexe, i.e. pourvu de parcelles plus petites et de plus importantes surfaces semi-naturelles (Rusch et al. 2013b; Lindgren et al. 2018). En effet, les populations de ravageurs apprécient des conditions paysagères simplifiées puisqu'elles sont très liées aux cultures seules (Thies et al. 2011). La diversité des couvertures du sol disponibles dans un paysage complexe favorise au contraire leurs prédateurs en leur fournissant une continuité de ressources alimentaires, avec des proies alternatives, d'habitats refuges et d'hivernages (Landis et al. 2000; Östman et al. 2001a; Woodcock et al. 2016).

Les carabes ne font pas exception : leur richesse spécifique ainsi que leur densité sont réduites dans des paysages où les parcelles sont grandes et où il y a peu d'éléments semi-naturels (Baranová et al. 2013). Par ailleurs, la proximité de prairies est favorable à leur diversité (Purtauf et al. 2005; Dufлот et al. 2017; Holland et al. 2017). D'une manière générale, la diversité des carabes est favorisée par des paysages plus hétérogènes des points de vue compositionnel et configurationnel (Östman et al., 2001). Pourtant, les carabes peuvent fournir un double contrôle biologique à l'agriculture (Kromp 1989; Kromp 1999; Moonen and Bàrberi 2008) : comme leurs régimes alimentaires peuvent varier selon l'espèce ils sont potentiellement prédateurs, polyphages ou phytophages. Ils peuvent donc contribuer au contrôle des populations de ravageurs et d'adventices.

Les araignées constituent un autre groupe d'arthropodes rampants qui peut contribuer à la régulation des ravageurs. Elles sont en effet carnivores et ont généralement une vaste gamme de proies potentielles, notamment les pucerons (Sunderland et al. 1986; Ekschmitt et al. 1997; Schmidt et al. 2003; Moonen and Bàrberi 2008). Les Lycosidae et les Linyphiidae sont les familles les plus représentées dans les cultures et ont des modes de prédation très différents : les premières chassent à terre au sol, alors que les secondes piègent leurs proies dans des toiles tissées dans la végétation.

Du point de vue conceptuel, le cadre de l'hétérogénéité fonctionnelle des paysages est particulièrement adapté à l'analyse de l'impact du contexte paysager en milieu agricole. Effectivement, les espèces sont regroupées par rapport aux habitats dont elles ont besoin pour couvrir leurs besoins en ressources (Fahrig et al. 2011). La complémentarité paysagère, découlant de l'hétérogénéité fonctionnelle, permet d'appréhender la nécessité pour certaines espèces de se déplacer entre les habitats voisins pour trouver une continuité de ressources (Dunning et al. 1992). Ainsi, les différents niveaux d'anthropisation des habitats entre les espaces naturels et les zones de culture procurent différentes ressources, complémentaires pour certaines espèces.

Dans cette thèse, nous proposons d'approfondir les connaissances sur les similarités entre les communautés de carabes de céréales et de prairies adjacentes, et d'aider ainsi à la compréhension des densités et richesses des carabes, potentiellement influencées par la complémentarité paysagère entre céréales et prairies. Nous souhaitons aussi apporter de nouvelles connaissances sur l'influence du contexte paysager sur les communautés de carabes de ces deux milieux adjacents. Par ailleurs, une meilleure connaissance de la répartition des traits fonctionnels des carabes entre céréales et prairies serait utile afin d'approcher l'intérêt de ces communautés en termes de lutte biologique. Cette connaissance serait également profitable dans différents contextes paysagers. Enfin, nous souhaitons apporter une meilleure compréhension des influences, qu'elles soient au niveau local de la parcelle ou paysagères, sur l'abondance et la richesse d'autres arthropodes auxiliaires, notamment les araignées, les syrphes et les chrysopes. En effet, ces groupes bénéficient aussi de la proximité entre céréales et prairies.

Nous avons ainsi échantillonné des arthropodes dans des céréales et prairies voisines de trois territoires d'études. Chacune de ces plaines agricoles représente en effet un équilibre différent entre les couvertures du sol des céréales et des prairies : le Rovaltain est largement dominé par les grandes cultures, en Bièvre la domination des cultures est moins nette, le Forez, enfin, présente autant de prairies permanentes que de grandes cultures annuelles.

Cette thèse propose donc de répondre à trois questions de recherche.

I. Quelles similarités les communautés de carabes présentent-elles entre céréales et prairies avoisinantes ?

Hypothèse H1 : les communautés de carabes de parcelles voisines partagent plus d'espèces en commun que celles qui sont plus éloignées.

Hypothèse H2 : les espèces communes aux deux milieux sont plutôt généralistes, i.e. mobiles et polyphages.

II. Comment le contexte paysager influence-t-il la diversité des carabes de céréales et prairies avoisinantes ?

Hypothèse H3 : une plus grande hétérogénéité compositionnelle et configurationnelle des paysages favorisent une plus grande diversité de carabes dans les céréales et prairies.

Hypothèse H4 : une plus grande couverture du sol par des éléments semi-naturels dans le paysage favorise une plus grande diversité de carabes dans les céréales et prairies.

Hypothèse H5 : une plus grande densité d'interface entre céréales et prairies dans le paysage améliore le ratio d'espèces partagées par les céréales et prairies voisines.

Hypothèse H6 : les prairies accueillent plus d'espèces phytophages, alors que les céréales accueillent plutôt des espèces carnivores et mobiles.

Hypothèse H7 : les espèces mobiles sont plus nombreuses dans les paysages faiblement hétérogènes.

III. Quelles sont les influences de paramètres locaux et paysagers sur les communautés d'autres arthropodes auxiliaires ?

Hypothèse H8 : les araignées sont plus diverses et abondantes dans les paysages dont la couverture en prairies et l'hétérogénéité compositionnelle sont plus grandes.

Hypothèse H9 : Les syrphes et chrysopes sont en plus grand nombre dans les paysages où la couverture en prairies est plus grande.

La complémentarité des prairies et céréales assure la diversité régionale des carabes

Dans ce chapitre, nous avons pour objectif de déterminer les influences relatives des paramètres locaux, comme le milieu d'échantillonnage, la taille ou la complexité de la parcelle échantillonnée, mais aussi de la variabilité des communautés de carabes d'un territoire d'étude à l'autre. Nous souhaitons également examiner les similarités entre les assemblages de carabes de prairies et de céréales, en les rapportant à leurs distances d'éloignement.

Nous avons observé des disparités importantes entre les communautés de carabes des céréales et des prairies : bien que les richesses spécifiques par échantillon ne soient pas significativement différentes, nous avons capturé plus de carabes dans les céréales que dans les prairies. Cependant, les assemblages

des prairies étaient sensiblement plus équitables que ceux des céréales, ce qui est cohérent avec le fait que nous avons échantillonné un total de 95 espèces différentes en prairies et 82 en céréales. Nous avons en outre observé une richesse spécifique par échantillon moindre en Rovaltain, le territoire où les prairies couvrent moins de surface. Les carabes étaient plus abondants dans les parcelles de céréales supérieures à 10 ha. Enfin, nous avons constaté que les assemblages étaient sensiblement plus similaires entre céréales et prairies voisines, ceux-ci présentaient des similarités significatives jusqu'à 4 km de distance entre les parcelles. Au contraire, les assemblages de territoire différents étaient significativement différents.

D'abord, nos résultats démontrent que les assemblages des carabes de céréales et de prairies présentent des divergences importantes dans leur structure. En conséquence, les assemblages locaux n'étaient pas plus riches en espèces dans un milieu plutôt que dans l'autre ; cependant, les assemblages des prairies étaient plus équilibrés dans la répartition des individus entre espèces. Dans les céréales, deux espèces seulement, *Poecilus cupreus* et *Anchomenus dorsalis* occupent 63% des effectifs totaux. Il est usuel de voir ces espèces dominer les habitats cultivés en Europe (Baranová et al. 2013; Bertrand et al. 2016; Lemic et al. 2017) puisqu'elles sont ubiquistes et tolèrent bien les perturbations dues aux activités agricoles (Thiele 1977; Luff 1996; Kromp 1999). Dans les prairies, les cinq espèces les plus abondantes se partagent 40% des effectifs totaux. Les prairies, en effet, sont moins perturbées par les activités agricoles et peuvent offrir une plus grande diversité d'habitats (Schaffers et al. 2008; Garcia-Tejero and Taboada 2016).

Néanmoins, les assemblages des céréales et prairies voisines étaient significativement plus similaires que pour des parcelles plus éloignées. Il est ainsi possible que malgré les différences importantes entre les deux milieux, les espèces soient filtrées par leur contexte paysager (Dufлот et al. 2014; Magura and Lovei 2019). Qui plus est, les assemblages de carabes sont significativement différents entre les territoires d'étude, ce qui met en évidence des *pools* d'espèces régionaux pour les carabes. En effet, le territoire d'étude était un facteur important d'explication de la richesse spécifique.

Il est possible que les similarités entre les assemblages de céréales et prairies voisins soient dues à des mouvements d'individus entre les deux milieux. Ces espèces communes sont sans doute ubiquistes, comme *P. cupreus* ou *A. dorsalis* ayant été échantillonnées dans les deux habitats. Ainsi, les carabes peuvent chercher refuge dans la prairie en cas de perturbation de la céréale, où ils peuvent trouver une continuité de ressources après la moisson (Schneider et al. 2016). Parfois même, ils hibernent dans la prairie et retourner dans les cultures voisines au printemps quand les conditions leur sont plus propices (Holland et al. 2005; Gallé et al. 2018a). Ainsi, céréales et prairies assurent une complémentarité de ressources pour les communautés de carabes (Fahrig et al. 2011; Dufлот et al.

2017). Cependant, la similarité que nous avons rencontrée dans les parcelles voisines reste relativement basse, avec une diversité beta de seulement 0.2 (Jost et al. 2011). Cela confirme que le premier déterminant des espèces de carabes reste le milieu d'échantillonnage (Thiele 1977; Luff 1996; Kromp 1999). Ainsi, malgré des similarités, les cortèges de carabes de prairies et céréales sont composés différemment.

La diversité paysagère et la densité d'interface bénéficient à la diversité des carabes dans les prairies et céréales voisines

Dans ce chapitre, nous nous intéressons aux influences de paramètres paysagers, concernant à la fois composition et configuration, sur la richesse spécifique des carabes dans des céréales et prairies voisines. L'hétérogénéité des paysages, qu'elle soit compositionnelle ou configurationnelle, favorise une plus grande diversité de carabes (Fahrig et al. 2011; Fahrig et al. 2015; Madeira et al. 2016). Dans les cultures, la proximité des prairies et des haies est aussi un facteur important (Purtauf et al. 2005; Duflot et al. 2017; Holland et al. 2017). En ce qui concerne les carabes des prairies, l'influence du paysage sur leur diversité est moins connue, même si Batáry et al., (2007) a observé qu'une importante couverture en prairies dans le paysage favorise des espèces spécialistes de ce milieu.

Nos travaux ont mis en valeur que les hétérogénéités compositionnelle et configurationnelle avaient toutes deux un effet sur la richesse spécifique des carabes des deux habitats réunis, ce qui est cohérent avec les études précédentes qui démontraient aussi l'intérêt d'une plus grande diversité paysagère pour la richesse spécifique des carabes dans les cultures et les milieux semi-naturels (Weibull et al. 2003; Hendrickx et al. 2007; Billeter et al. 2008).

Toutefois, une plus grande diversité compositionnelle a eu un effet négatif pour la richesse spécifique des carabes dans les prairies du Forez. Ce territoire présente en effet la particularité d'être le plus riche en prairies permanentes. Par ailleurs, les zones largement dominées par les prairies en Forez sont pourvues d'une faible diversité compositionnelle, justement car les prairies y couvrent une grande surface. Dans des paysages similaires, Batáry et al. (2007) ont démontré que les communautés des prairies sont moins riches lorsque le paysage est plus diversifié, donc moins couvert de prairies. En effet, lorsque les prairies dominent, un plus grand nombre d'espèces spécialistes de ces milieux les colonisent, alors qu'en présence de cultures, les prairies sont colonisées par des espèces plus généralistes.

Pour autant, nous n'avons pas trouvé d'effet du paysage sur les communautés de carabes des céréales, ce qui va à l'encontre des études connues, qui démontrent un effet positif de la proximité d'éléments semi-naturels (Purtauf et al. 2005; Burel and Baudry 2005; Duflot et al. 2017; Holland et al. 2017) ou

d'une plus grande hétérogénéité du paysage (Fahrig et al. 2011; Fahrig et al. 2015; Madeira et al. 2016). Nous expliquons principalement ce résultat par une faible utilisation d'insecticides dans les parcelles échantillonnées, permettant une relative stabilité des communautés, alors dominées par des ubiquistes (Navntoft et al. 2006; O'Rourke et al. 2008). Il en résulte une communauté très adaptée à cet habitat, et donc peu influencée par le contexte paysager d'où d'autres espèces pourraient provenir et coloniser la parcelle par compétition.

Nos analyses ont démontré qu'une plus grande densité d'interface entre céréales et prairies dans le paysage alentour des deux parcelles favorise une plus grande proportion d'espèces partagées par les deux habitats voisins. De fait, les cultures sont des habitats régulièrement perturbés par les activités agricoles, la communauté de carabes peut se réfugier par *spill-over* dans les habitats semi-naturels environnants, comme les prairies (Schneider et al. 2016). Les prairies permanentes, habitats stables, peuvent donc assurer une complémentarité et une continuité de ressources à leurs communautés des cultures voisines (Dunning et al. 1992; Pfiffner and Luka 2000; Fahrig et al. 2011) ou même des habitats d'hivernage (Holland et al. 2005; Gallé et al. 2018a).

Nos résultats soutiennent donc la possibilité que les carabes migrent entre céréales et prairies voisines pour trouver une continuité de ressources par complémentarité. Les prairies peuvent donc être des habitats importants pour les communautés des cultures adjacentes, même dans le cas de paysages intensivement cultivés et même si elles sont de taille réduite (Knapp and Řezáč 2015). Plus généralement, une diversité de cultures différentes accompagnées d'habitats semi-naturels sont nécessaires pour assurer une plus grande biodiversité dans la mosaïque paysagère agricole (Sirami et al. 2019).

Traits fonctionnels des communautés de carabes dans des prairies et céréales voisines

La plupart des carabes sont aphidophages, même si certaines espèces parmi les plus grandes peuvent aussi se nourrir d'escargots ou de limaces (DeBach and Rosen 1991; Dainese et al. 2017b; Altieri et al. 2018). Quelques espèces de carabes sont phytophages et se nourrissent de graines d'adventices (Menalled et al. 2007; Bretagnolle et al. 2012; Trichard et al. 2013). Enfin, les polyphages, plus généralistes, peuvent se nourrir à la fois de végétaux et d'invertébrés. Dans tous les cas, les carabes constituent une famille intéressante pour le contrôle biologique des ravageurs et des adventices.

L'objectif de ce chapitre est ainsi de relier les occurrences des traits fonctionnels des carabes à la parcelle d'échantillonnage et sa couverture du sol, mais aussi au contexte paysager alentour. Nous comparerons donc les communautés de carabes de cultures de céréales et de prairies voisines et nous concentrerons sur les traits fonctionnels liés à l'alimentation et la mobilité des carabes. Enfin, nous

nous intéresserons aux traits fonctionnels des espèces partagés par les céréales et les prairies voisines, afin d'en déduire leur éventuel intérêt pour le contrôle des adventices et ravageurs.

Nous avons ainsi pu observer que les carabes polyphages étaient plus fréquemment communs aux deux couvertures du sol voisines. Leur diversification alimentaire, qui leur permet de se nourrir à la fois d'invertébrés et de végétaux, donc de ravageurs et de graines d'adventices, est un atout pour profiter des deux habitats différents (Thiele 1977; Luff 1996; Kromp 1999). Ainsi, ils peuvent migrer de la culture vers la prairie en cas de perturbations dues à l'activité agricole ou tout simplement si les ressources viennent à manquer (Östman et al. 2001b). Ils peuvent aussi se déplacer par *spill-over* au moment de la moisson et hiverner dans les prairies le cas échéant (Geiger et al. 2009; Alignier et al. 2014). Par ailleurs, nous avons trouvé une relation positive entre l'occurrence d'espèces polyphages et la couverture en prairies permanentes dans le contexte paysager. Ainsi, nos analyses mettent en évidence l'importance de la complémentarité des ressources entre céréales et prairies voisines pour les carabes polyphages.

Cependant, nous avons trouvé que l'habitat d'échantillonnage est le facteur essentiel dans la détermination des traits fonctionnels des espèces qui le peuplent, ce qui est conforme aux travaux précédents (Tuck et al. 2014; Caro et al. 2016; Gayer et al. 2019). Aussi, les espèces carnivores, exclusivement prédatrices ou polyphages, étaient plus fréquentes dans les cultures, probablement du fait de la plus grande disponibilité de proies, notamment les ravageurs (Bryan and Wratten 1984; Holland et al. 2004; Winqvist et al. 2014; Hanson et al. 2016). En revanche, les phytophages étaient typiques des prairies, où ils trouvaient des ressources alimentaires végétales en plus grandes abondance et diversité (Klimeš and Saska 2010; Diehl et al. 2012). De fait, les carabes typiques des cultures sont pour la plupart des espèces ubiquistes, capables de supporter les perturbations anthropiques de l'agriculture ou de se déplacer vers des milieux voisins plus stables en cas de besoin (Kromp 1989; Kromp 1999).

Les carabes macroptères ont été indifféremment échantillonnés dans les céréales et prairies, certainement car ils sont plus mobiles et donc capables de se déplacer entre les deux milieux quand ils en ont besoin (Ribera et al. 2001; Hanson et al. 2016). Au contraire, les petits carabes aptères, peu mobiles, étaient plus typiques des prairies, où ils sont soumis à des perturbations moindres et moins régulières (Tilman and Downing 1994). Cela expliquerait pourquoi les carabes aptères étaient plus fréquents dans les prairies entourées d'un paysage riche en prairies. En effet, Batáry et al. (2007) ont mis en évidence la prééminence des espèces spécialistes dans des prairies entourées d'autres prairies. En revanche, les généralistes prennent le dessus dans les communautés de prairies plus entourées de cultures.

Les populations de carabes des prairies peuvent être menacées, du fait qu'elles sont plus spécialistes que celles des cultures, et donc plus vulnérables à la fragmentation de leur habitat (de Vries et al. 1996; Henle et al. 2004; Hendrickx et al. 2007). Nous en concluons que le maintien ou la restauration d'une mosaïque de prairies serait utile à deux titres dans les paysages agricoles. Premièrement pour assurer une complémentarité de ressources aux communautés des cultures, pour lesquelles un habitat de substitution peut être utile en cas de perturbation ou pour l'hivernage. Secondement, la préservation des espèces typiques des prairies nécessite la disponibilité d'autres prairies à proximité.

Araignées, pollinisateurs et paramètres locaux et paysagers

Les araignées peuvent constituer d'intéressants auxiliaires pour le contrôle biologique des ravageurs (Sunderland et al. 1986; Nyffeler and Sunderland 2003; Moonen and Barberi 2008). Elles sont en effet des prédateurs généralistes, dont les modes de chasse sont complémentaires au sein du groupe, entre piégeage par toile ou course, à la fois dans la végétation et au sol, en ce qui concerne les deux familles les plus présentes dans les cultures : les Lycosidae et les Linyphiidae (Ekschmitt et al. 1997). Leur abondance et leur richesse spécifiques sont toutes deux positivement influencées par la proximité d'éléments semi-naturels dans le paysage, où elles peuvent trouver refuge en cas de perturbation de la culture (Concepción et al. 2012; Gallé et al. 2018a).

Les syrphes et les chrysopes sont des familles qui procurent des services écosystémiques doubles : les larves sont prédatrices des pucerons, notamment dans les cultures pour certaines espèces, alors que les adultes sont pollinisateurs (Moonen and Barberi 2008; Moquet et al. 2018). Aussi, la disponibilité d'habitats riches en pucerons à proximité de zones avec une diversité florale importante leur est bénéfique (Le Féon et al. 2010; Cole et al. 2017). La proximité de cultures avec des habitats semi-naturels, comme les prairies permanentes, favorise ainsi leur abondance et leur diversité spécifique (McEwen et al. 2007).

Dans ce chapitre, nous étudierons les facteurs déterminant la richesse familiale et l'activité-densité des araignées dans des prairies et céréales voisines, en nous intéressant particulièrement à des paramètres concernant la parcelle échantillonnée, mais aussi son contexte paysager. Ensuite, nous analyserons de même l'activité-densité des syrphes et des chrysopes selon les mêmes paramètres locaux et paysagers.

Nos observations ont démontré que la richesse familiale des araignées n'était déterminée que par des paramètres locaux et non paysagers. Ainsi, les prairies offraient des diversités familiales d'araignées plus importantes que les cultures. Comme attendu, les échantillonnages étaient dominés par les Lycosidae et les Linyphiidae. Il est possible que la forte prépondérance des premières explique

l'importance de paramètres locaux liés à la parcelle d'échantillonnage. En effet, les Lycosidae étant rampantes, leur mobilité est faible (Duelli et al. 1990). Bien que cette observation soit en cohérence avec d'autres études (Concepción et al. 2008; Batáry et al. 2012), elle est aussi en opposition avec d'autres travaux qui démontrent l'importance de la proximité d'éléments semi-naturels comme des haies, des bandes enherbées ou des prairies pour améliorer la diversité spécifique des araignées (Schmidt et al. 2005a; Hendrickx et al. 2007; Concepción et al. 2012). Il est possible que cette divergence de nos observations soit due au manque de finesse d'un indicateur comme la richesse familiale, comparée à la richesse spécifique utilisée dans ces études. Cependant, nos résultats ont montré que la densité des araignées était plus importante dans des paysages avec une plus grande couverture en prairies permanentes. En effet, la proximité de prairies peut procurer des habitats de refuge ou d'hivernage et ainsi recoloniser les cultures plus aisément (Lemke and Poehling 2002). Cette observation est particulièrement vraie pour les Lycosidae et Linyphiidae, les deux familles que nous avons le plus capturées (Gardiner et al. 2010).

Nous avons observé que la couverture en prairies dans le paysage influençait négativement le nombre de syrphes et de chrysopes échantillonnés, ce qui est en cohérence avec les observations de Haenke et al. (2009). En effet, alors que la richesse spécifique de ces pollinisateurs est favorisée par la proximité d'éléments semi-naturels dans le paysage, leur abondance est au contraire négativement influencée par celle-ci (Meyer et al. 2009). Ainsi, une plus grande diversité floristique est bénéfique à un plus grand nombre d'espèces de pollinisateurs mais une plus grande surface en culture profite aux larves. Aussi, nous avons échantillonné plus de chrysopes et de syrphes dans des paysages dominés par des grandes cultures annuelles, milieux riches en pucerons (Sadeghi and Gilbert 2000; Meyer et al. 2009).

Ces résultats confirment l'importance des prairies pour les communautés d'auxiliaires des cultures annuelles. Les prairies procurent en effet une continuité de ressources complémentaires, en cas de perturbation de la culture par les activités agricoles. Néanmoins, la capacité de dispersion des pollinisateurs ailés peut leur permettre d'être moins dépendants de la proximité de prairies, alors que de grandes surfaces en culture peuvent fournir une ressource dense en pucerons et favoriser un plus grand nombre de larves. Ainsi, les prairies peuvent être elles-mêmes complémentées par des habitats dont la diversité florale est plus importante, comme des bandes fleuries, et ainsi assurer des ressources florales à une plus grande diversité de pollinisateurs.

Discussion générale et conclusion

Dans cette thèse, nous avons observé que les communautés de carabes des céréales et prairies étaient structurées très différemment, malgré des richesses spécifiques moyennes équivalentes. En effet, dans les prairies, les communautés étaient distribuées de manière bien plus équitable entre les espèces. Au

contraire, dans les céréales, deux espèces ubiquistes dominant en nombre. Néanmoins, nous avons observé que la richesse spécifique partagée par les deux parcelles de céréales et prairies voisines était significativement plus grande qu'entre parcelles éloignées, notamment au-delà de 4 km de distance entre les parcelles.

En outre, nos résultats ont démontré que la proportion d'espèces communes aux deux habitats voisins était supérieure quand la densité d'interfaces entre céréales et prairies augmentait dans le paysage alentour. La richesse spécifique des carabes des deux habitats était aussi favorisée par des paysages à la composition plus diversifiée, à l'exception du Forez où une plus grande diversité était corrélée à une moins grande couverture en prairies permanentes. L'hétérogénéité configurationnelle a elle aussi un impact positif sur les carabes et leur richesse cumulée dans les deux habitats.

Concernant les traits fonctionnels des carabes, nous avons observé que les espèces polyphages étaient plus fréquemment capturées dans les céréales et prairies voisines, alors que les prédateurs étaient surtout exclusifs dans les céréales et les phytophages dans les prairies. Les carabes petits et aptères, peu mobiles, ont été avant tout trouvés dans les prairies, mais les espèces macroptères étaient indifféremment rencontrées dans les céréales et prairies. Les carabes polyphages étaient favorisés par des paysages avec une plus grande couverture en prairies, mais aussi une plus faible diversité compositionnelle. Les carabes exclusivement prédateurs étaient favorisés par une plus grande hétérogénéité configurationnelle.

Nos observations ont seulement démontré une influence du milieu d'échantillonnage sur la richesse familiale des araignées, mais pas du contexte paysager. En effet, nous avons trouvé en moyenne plus de familles différentes dans les prairies que dans les céréales. La densité des araignées était en revanche influencée par des paramètres paysagers : une plus grande couverture en prairies à proximité augmentait le nombre d'araignée, alors que la diversité compositionnelle avait un effet négatif sur le nombre d'araignées capturées en céréales. Au sujet des pollinisateurs : nous en avons capturé moins dans des parcelles entourées d'une plus couverture en prairies, autant dans le cas des syrphes que des chrysopes. À l'inverse, la densité de ces pollinisateurs était plus grande dans des paysages dominés par les grandes cultures annuelles.

Nous tâcherons maintenant de formuler un ensemble de recommandations, basées sur nos observations et renforcées par la littérature scientifique existante, pour améliorer les synergies entre agriculture, paysage et biodiversité auxiliaire.

Notre principale préconisation concerne la nécessité de préserver voire de restaurer, une mosaïque de prairies permanentes dans les paysages agricoles, y compris ceux dominés par les grandes cultures

annuelles. Cette recommandation est d'ailleurs soutenue par d'autres travaux de recherche (Bretagnolle et al. 2012; Lindgren et al. 2018). En effet, les prairies peuvent fournir une continuité de ressources et d'habitat aux communautés provenant des cultures voisines (Roume 2011; Schellhorn et al. 2014)., notamment en cas de perturbations dues aux activités agricoles (Schneider et al. 2013; Schneider et al. 2016), comme le suggère la complémentation paysagère (Dunning et al. 1992; Fahrig et al. 2011). Par ailleurs, les prairies peuvent fournir des sites d'hivernage aux insectes rampants, à l'abri du labour (Coombes and Sothertons 1986; Petersen 1999; Tscharrntke et al. 2005b). L'implantation d'une mosaïque prairiale dans les paysages agricoles aurait de surcroît la vertu de renforcer la résilience des communautés d'auxiliaires dans les cultures, en fournissant habitat et ressources à des espèces non-généralistes ou non-ubiquistes (Elmqvist et al. 2003; Bengtsson et al. 2003).

Même si nos résultats ne sont pas probants concernant l'impact bénéfique des prairies sur la densité de pollinisateurs, nous avons montré que nous n'avons pas été en mesure de comptabiliser leur richesse spécifique. Pourtant, la proximité de prairies permet aux syrphes et chrysopes de disposer de ressources alimentaires pour les larves, se nourrissant de pucerons dans les cultures, ainsi que pour les adultes, se nourrissant de nectars floraux (Hickman and Wratten 1996; Long et al. 1998; Tscharrntke et al. 2005b).

Afin de favoriser une meilleure complémentation paysagère pour les arthropodes auxiliaires, il est par ailleurs intéressant d'augmenter la diversité des cultures dans les paysages agricoles. De fait, augmenter la diversité compositionnelle des paysages agricoles est bénéfique pour la biodiversité (Fahrig et al. 2015; Gallé et al. 2018a; Sirami et al. 2019). Les auxiliaires peuvent trouver une ressource alimentaire en continu durant toute l'année (Kleijn and van Langevelde 2006) et mieux soutenir les rendements des cultures (Östman et al. 2001a). En effet, en présence d'une diversité de cultures, les auxiliaires rampants comme les carabes ou les araignées peuvent se déplacer entre les différentes cultures ou habitats semi-naturels pour trouver leurs ressources alimentaires (Thorbek and Bilde 2004; Tscharrntke et al. 2005b; Sirami et al. 2019).

Un paysage agricole de plus petite échelle, avec des parcelles réduites, permettrait par ailleurs de faciliter ce mouvement des arthropodes rampants entre les diverses parcelles. D'une part, une plus grande hétérogénéité configurationnelle favorise une plus grande biodiversité, notamment en ce qui concerne les carabes et les araignées (Fahrig et al. 2015; Petit et al. 2017; Gallé et al. 2018b). D'autre part, de plus petites parcelles sont plus faciles à coloniser jusqu'au cœur de la parcelle (Merckx et al. 2009; Woodcock et al. 2016).

Cette thèse a pour objet de proposer des leviers d'actions à l'égard des autorités publiques, collectivités territoriales et de l'État, mais aussi des agriculteurs, dans l'objectif de progresser vers une meilleure organisation des paysages agricoles favorisant la biodiversité fonctionnelle. Nous avons ciblé spécifiquement les prairies permanentes car elles sont à la fois des habitats semi-naturels et des surfaces productives pour l'agriculture.

A l'égard des pouvoirs publics, nous avons envisagé quelques politiques agro-environnementales qui permettrait de diversifier les paysages agricoles et de permettre une complémentarité paysagère pour les arthropodes auxiliaires. Ainsi, dans le Rovaltain et en Bièvre dans une moindre mesure, nous suggérons la mise en place d'une mesure agro-environnementale qui favorise la préservation ou la restauration de prairies permanentes. L'enjeu de restauration est particulièrement important dans le Rovaltain, comme les prairies n'y représentent que 3% des surfaces régionales, largement concentrées sur le piémont du Vercors et non dans la plaine agricole. Dans les trois régions d'études, il serait aussi important d'augmenter la diversité des cultures, en favorisant l'implantation de légumineuses par exemple. Une subvention à la diversité des cultures via une mesure agro-environnementale pourrait ainsi être utile, accompagnée d'une aide à la valorisation économique de ces productions, par exemple via la restauration collective sur laquelle les collectivités territoriales ont la main. Enfin, faute de prairies permanentes, il pourrait être pertinent *a minima* d'accompagner la mise en place de prairies temporaires longues dans les rotations culturales car elles peuvent procurer une certaine stabilité. Une durée de quatre ans pour ces prairies temporaires semble acceptable.

Concernant nos préconisations à l'égard des agriculteurs : nous sommes conscients que ces derniers sont fortement contraints par la valorisation économique de leur parcellaire. Les agriculteurs peuvent agir sur deux plans, celui des pratiques et celui des paysages. Ils peuvent ainsi décider de leur propre chef de préserver ou restaurer des prairies permanentes au sein de leur parcellaire, ou au moins d'inclure des prairies temporaires longues dans leurs rotations. En ce qui concerne le paysage, les pouvoirs publics devraient soutenir financièrement comme institutionnellement les agriculteurs. En effet, la gestion du paysage agricole reste difficile tant que chacun se limite à son propre parcellaire. Bien que les agriculteurs aient la main sur le paysage, ils sont soumis à de nombreuses contraintes. Pourtant, leur action a un impact direct sur la qualité des services écosystémiques fournis par le paysage agricole, et dont profitent de nombreux acteurs du territoire (Power 2010). C'est pourquoi Lescourret et al. (2015) proposent d'impliquer tous les acteurs locaux dans des processus décisionnels collectifs et participatifs. Ainsi, il est proposé de constituer des communautés décisionnelles régies par un cadre de travail socio-écologique, inspiré de celui des Communs et largement documenté par Elinor Ostrom (2008; 2012; 2015). Ces communautés permettraient alors une gestion du paysage agricole partagée et concertée, prenant en compte les enjeux et intérêts de chacun. Il serait alors possible

d'envisager, par exemple, un remembrement écologique, qui permettrait de favoriser la biodiversité auxiliaire sans mettre en péril les agriculteurs individuellement.

Toutes ces considérations nous interrogent sur les processus décisionnels des agriculteurs, qui sont bien souvent tributaires de contraintes économiques, et sur l'impact de ces processus sur nos paysages. Pourtant, pour assurer une agriculture durable, il est nécessaire que nous sachions préserver les services écosystémiques sur lesquels elle repose. Il est tout aussi essentiel que les agriculteurs puissent vivre décemment de leur travail. Aussi, de nombreuses questions devraient être résolues démocratiquement à des échelles locales et non seulement par des votes d'envergure nationale. La contrainte économique fait malheureusement échapper ces enjeux au consentement démocratique : il est probablement temps d'en finir avec la primauté de l'économique sur des questions socio-écologiques, et d'ainsi construire des démocraties plus adaptées aux enjeux contemporains.

Abstract

Title: Carabids and other beneficial arthropods in cereal crops and permanent grasslands and influence of field and landscape parameters

Keywords: *agricultural landscapes; agrobiodiversity; agroecology; beneficial insects; ecology; ground beetles; conservation biological control; natural enemy.*

Biodiversity is decreasing dramatically worldwide with land use change and habitat degradation being among its major causes. In Europe, this biodiversity loss is strongly related to the intensification of agriculture which has led to the simplification of landscapes. This resulted in the homogenization of landscapes where only a few crops dominate, accompanied with an increase of field size. Natural and semi-natural landscape elements, such as hedgerows, vegetation strips and groves were withdrawn, while more and more grasslands were being cropped or abandoned. Yet, grasslands are important functional biodiversity providers for crops in agricultural landscapes, including species that can provide ecosystem services such as pest control or pollination to farming activities. This PhD thesis therefore aimed at disentangling the influence of field and landscape parameters on the arthropod communities of adjacent grasslands and croplands of agricultural landscapes.

We sampled arthropods from pairs of neighboring cereal fields and grasslands in order to compare the field and landscape influences on the biodiversity of these two agricultural land cover types. Our research took place in three study regions of southeastern France, each of them representing a different gradient between annual winter cereal crops and permanent grasslands. We mainly focused on carabids, though we also studied to some extent ground-dwelling spiders as well as pollinators such as hoverflies and lacewings. The landscape parameters were based on a land cover recording of cropped, grasslands and (semi-)natural areas and linear elements 500 m around every sampled location.

Concerning carabids, cropland and grassland assemblages remained mainly distinct, but they showed higher similarity when located closer, up to 4 km from each other. Carabid activity-density was higher in the study regions with higher grassland coverage. In grasslands, we found a higher species richness when the landscape diversity around was increased, except for the study region which was strongly dominated by grassland. In winter cereal crops, the landscape parameters showed no significant effect on carabid species richness. Moreover, the common species richness in neighboring cereal fields and grasslands was enhanced by higher density of field borders between these two land cover types in the studied landscapes. Though the land cover type was by far the major determinant of carabid traits, landscape parameters also had a significant influence. Polyphagous species tended more to be commonly appearing in neighboring grassland and cereal crop. Phytophagous species were highly exclusive to grasslands, while predatory were it in cereal crops.

Regarding other arthropod groups, we observed that the spider family richness was higher in permanent grasslands, though there were more individuals caught in cereal fields. Both hover flies and lacewings sampled density were higher in cereal fields and lower in the neighboring of higher grassland coverage.

This thesis indicates that the preservation and restoration of a mosaic of permanent grasslands within diversely cropped landscapes is important for functional biodiversity. The inclusion of grasslands can enhance the diversity of beneficial arthropods and provide complementary resource and habitats to communities for pest control in crops.

Résumé

Titre : Influence du paysage et de la parcelle sur les diversités de carabidés et d'autres arthropodes en céréales et prairie permanentes

Mots clefs : agroécologie ; agrobiodiversité ; arthropodes auxiliaires ; écologie ; lutte biologique par conservation ; paysages agricoles

La biodiversité connaît un déclin préoccupant à l'échelle mondiale, les modifications et dégradations des habitats en demeurent l'une des causes principales. En Europe, la perte de biodiversité est étroitement liée à l'intensification de l'agriculture, qui a conduit à la simplification des paysages. En a résulté l'homogénéisation des paysages, où une faible diversité de cultures domine, ainsi qu'un agrandissement des parcelles. Les éléments naturels et semi-naturels, tels que les haies, les bandes enherbées ou les bosquets, furent retirés, alors que les prairies permanentes furent mises en culture ou abandonnées. Les prairies sont pourtant essentielles pour la biodiversité auxiliaire, car elles abritent et favorisent des espèces qui peuvent fournir lutte biologique et pollinisation à l'agriculture. Cette thèse propose donc de distinguer les influences de la parcelle, locale, et du paysage sur les communautés d'arthropodes de prairies permanentes et de cultures céréalières avoisinantes.

Nous avons échantillonné des arthropodes d'appariement de céréales et prairies voisines, afin de comparer les effets de paramètres locaux et paysagers sur les biodiversités de ces deux couvertures du sol typiques des paysages agricoles. Nous avons mené ces travaux dans trois territoires différents, tous situés en Auvergne Rhône-Alpes. Chaque territoire était représentatif d'un gradient d'équilibre différent entre les couvertures en cultures annuelles et prairies permanentes. Notre intérêt s'est principalement porté sur les carabes, bien que nous ayons aussi étudié, dans une moindre mesure, les araignées ainsi que des pollinisateurs volants tels que les syrphes et les chrysopes. Les paramètres paysagers ont été établis à partir d'un recensement manuel de toutes les couvertures du sol, cultivées ou naturelles, ainsi que des éléments linéaires dans un rayon de 500 m autour de chaque site échantillonné.

Les assemblages de carabes dans les prairies et céréales étaient très distincts, même s'ils ont présenté plus de similarités quand ils étaient plus proches, dans des parcelles distantes jusqu'à 4 km l'une de l'autre. L'activité-densité des carabes était supérieure dans les territoires où la couverture globale en prairies permanentes était plus importante. Dans les prairies, nous avons trouvé une plus grande richesse spécifique dans des contextes paysager plus diversifiés, à l'exception du territoire fortement dominé par des prairies. Nos analyses n'ont pas mis en évidence d'effet du paysage sur la richesse spécifique des carabes dans les céréales. Par ailleurs, la richesse spécifique commune aux deux couvertures du sol était plus importante dans des contextes paysagers où céréales et prairies partageaient plus de bordures ensemble. Bien que le type de couverture du sol fût un facteur majeur dans la détermination des traits de vie des carabes, les paramètres paysagers eurent aussi leur importance. Ainsi, les espèces polyphages furent les plus sensibles d'être échantillonnées à la fois dans des prairie et céréale appariées. Les espèces phytophages ont ainsi été très souvent exclusivement échantillonnées dans les prairies, alors que les prédatrices l'étaient dans les céréales.

Concernant les autres arthropodes, nous avons observé une plus grande richesse en familles d'araignées dans les prairies, bien qu'elles présentassent plus d'individus dans les céréales. Le nombre de syrphes et de chrysopes échantillonnés était plus important dans les céréales, et négativement influencé par la couverture paysagère en prairies.

Notre thèse indique qu'il serait utile de préserver et restaurer une mosaïque de prairies permanentes dans les paysages agricoles diversifiés. Les prairies peuvent en effet améliorer la diversité auxiliaire des arthropodes et procurer des ressources complémentaires à leurs communautés.