

Optimization of the supercritical extraction of rosmarinic acid from clary sage residue and the antioxidant activity of the extracts

Morad Chadni, Emilie Isidore, Fabien Lagalle, Maxime Langlait, Abdouramane Dosso, Irina Ioannou

URD Agro-Biotechnologies Industrielles, CEBB, AgroParisTech, 51110 Pomacle, France

Highlights:

- Clary sage distillation residues are rich in rosmarinic acid.
- A pressure of 100 bar and a temperature of 65 °C were optimal for the extraction.
- 10 % of co-solvent (w/w) is the best concentration to extract rosmarinic acid.
- 35 % (v ethanol/v water) is the best co-solvent composition.
- The obtained extracts are rich in antioxidants.

Abstract:

This study focuses on the extraction of bioactive compounds from clary sage (*Salvia sclarea* L.) distillation residue with carbon dioxide under supercritical conditions. The target component is rosmarinic acid, a naturally occurring phenolic compound with strong antioxidant properties. Response surface methodology was applied to optimize the operating temperature, pressure and the co-solvent composition in the range of 40–100 °C, 100–600 bar, and 0–100% ethanol in water (v/v), respectively. The quantification of rosmarinic acid was performed using HPLC and the antioxidant activity of extracts was measured using DPPH assay. Results showed that the yield of extraction of rosmarinic acid and the antioxidant activity of the extracts varied significantly at each extraction condition. Based on the optimization study, the optimum pressure, temperature and the composition of the co-solvent were 100 bar, 65 °C and 35% ethanol, respectively, with more than 8 mg/g of rosmarinic acid concentration obtained.

Keywords:

Supercritical carbon dioxide, rosmarinic acid, optimization, clary sage, polyphenol Extraction

1. Introduction

Clary sage (*Salvia sclarea* L.) is one of the most popular species of the *Salvia* genus. *Salvia* (sage) plants are widely used as cooking additive, ornamental and landscape plant, and in herbal medicine. The major part of clary sage culture is located in the European Union and North America [1]. The health benefits of sage plants have been known since ancient times. Commercially available herbal agents containing sage are used to treat gastrointestinal disorders and help to absorb nutrients, act as antiemetics and eliminate some symptoms of menopause and estrogen deficiency. In traditional herbal medicine, the plant is used as an antihidrotic, spasmolytic, antiseptic, and anti-inflammatory agent [2]. Sage is well-known as one of the richest natural source of antioxidants, its medicinal value is directly related to this property. Indeed, phenolic compounds are commonly considered to be responsible for the antioxidant properties of sage plants. Rosmarinic acid (RA), one of the most abundant phenolic acid in sage plants, is common to many *Salvia* species [3] and known for its antioxidant properties which make it able to neutralize free radicals in the human body, thus preventing the cells from harmful oxidative action and the growth of various human cancer cell lines [4]. Moreover, by preventing lipid oxidation in food, it prolongs the shelf-life of consumer products containing lipids [5–7]. For all these reasons, formulations with RA are extensively used in food, pharmaceutical and cosmetic industries [8–10]. In this context, it is particularly interesting to have available bio-based RA or extracts rich in RA. The recovery of RA from sage has been performed using conventional methods based on solid-liquid extraction using organic solvents [11–13]. Conventional extraction methods, including maceration, percolation and reflux extraction, usually use organic solvents and require a large volume of solvents and a long extraction time [14]. Moreover, they have undesirable effects on the environment and food safety. Moreover, high extraction temperatures and long extraction time can lead to the degradation of phenolic compounds [15]. Therefore, it is important to use new extraction technologies that are faster and with reduced organic solvent consumption without altering the quality of the extracts. Carbon dioxide in supercritical phase is increasingly being implemented as an extraction solvent as it is non-toxic, non-flammable, readily available, cost-effective and easily removed from extracted materials [16]. Due to the polarity of RA, the use of a co-solvent is essential to reach the extraction yields of conventional techniques. Water and ethanol have been widely used as co-solvents due to their low cost, besides being green solvents, with the possibility of direct use in foods and pharmaceuticals. Furthermore, the use of water-ethanol mixtures as co-solvents has been shown to be more efficient in the extraction of phenolic compounds in high yields [17–19]. However, to the best of our knowledge, and based on a recent review [20], SC-CO₂ extraction of RA has only been performed from lemon balm (*M. officinalis*) [21] and rosemary (*Rosmarinus officinalis*) [22,23]. To the best of our knowledge, this is the first work investigating the SC-CO₂ extraction of RA from *Salvia sclarea* L. The current industrial biorefinery process of *Salvia sclarea* L. consists in sclareol extraction after harvesting or on distillation by-products [24]. In 2017, Dufour have found that a pressure of 30 MPa and a temperature of 40 °C were suitable for the extraction of sclareol from clary sage [25]. Bakó et al. (2021) have studied the optimization of the antibacterial activity of clary sage supercritical fluid extracts. The optimum extraction parameters were 18.6 MPa pressure, 40 °C temperature, and 2% ethanol (EtOH) ratio [26].

SC-CO₂ has been proven to successfully extract clary sage essential oil and sclareol [26–28]. An additional extraction step with co-solvent will allow the extraction and the valorization of phenolic compounds, thus making biorefining more efficient, profitable and cost-effective. The objective of this paper is to implement and optimize the extraction of RA from clary sage distillation residue using SC-CO₂. For this purpose, the extraction conditions namely, temperature, pressure and the co-solvent composition were optimized regarding the yield of RA and the antioxidant activity of the extracts using response surface methodology.

2. Materials and methods

2.1. Chemicals

CO₂ used in the experiments was 99.5% pure and supplied by Linde France S.A (Lyon, France). Ethanol (99.9%), methanol (99.9%), acetonitrile (99.9%) and formic acid (98–100%) were purchased from Thermo Fisher, Illkirch France. Ultra-pure water was prepared from a Milli-Q system (Millipore Corporation, USA). The reagents DPPH (2,2- Diphenyl-picrylhydrazyl) (>97.5%) and Trolox® (6-hydroxy-2,5,7,8- tetramethylchromane-2-carboxylic acid) (>98.5%) were obtained from VWR, Fontenay-sous-Bois, France.

2.2. Plant material

The extractions were carried out on the aerial parts of clary sage (*Salvia sclarea* L.) obtained after distillation process. The residue was provided by ITEIPMAI (The French research institute for perfume, medicinal and aromatic plants, France) dried at room temperature and ground in a cutting mill with 4 mm mesh. The rosmarinic acid content in the raw material is 8.346 ± 0.918 mg/g DM. It was measured by accelerated solvent extraction after five cycles (15 min each) of extraction (depletion) at 70 °C using 70% ethanol as solvent.

2.3. SC-CO₂ extraction equipment

The extractions were carried out using a supercritical fluid extraction system (SFE PROCESS, Nancy, France), equipped with a 1 L extraction vessel (flow plug-type) and 3 separators (0.2 L) in series (S1, S2 and S3). A simplified flow sheet of SFE pilot is given Fig. 1. 25 g of clary sage distillation residue were placed in a 250 mL sample cell. The SC-CO₂ flow was downward and the flow rate was kept constant at 60 g/min during the experiments. Pressure and temperature ranged between 100 and 600 bar and 40 and 100 °C, respectively, based on the work of Abdul Aziz (2022). Indeed, the solubility of RA in SC-CO₂ depends on the temperature and pressure (density of CO₂), Abdul Aziz et al., in 2022 have found that the highest RA solubility was obtained at 80 °C and 100 bar (the lowest density of CO₂ at 229.611 g/L), whereas the lowest RA solubility was obtained at 40 °C and 200 bar (the highest density of 836.246 g/L [29]). The SC-CO₂ equipment contained a second pump to give the possibility to add co-solvent. Indeed, due to the polar structure of RA, its extraction was carried out using a co-solvent, which is a mixture between two polar modifiers, ethanol (polarity = 5.2) and water (polarity = 9) [30]. Different flow rates and ethanol concentrations were tested for the RA extraction. The separator temperature and pressure were 60 °C and 50 bar respectively.

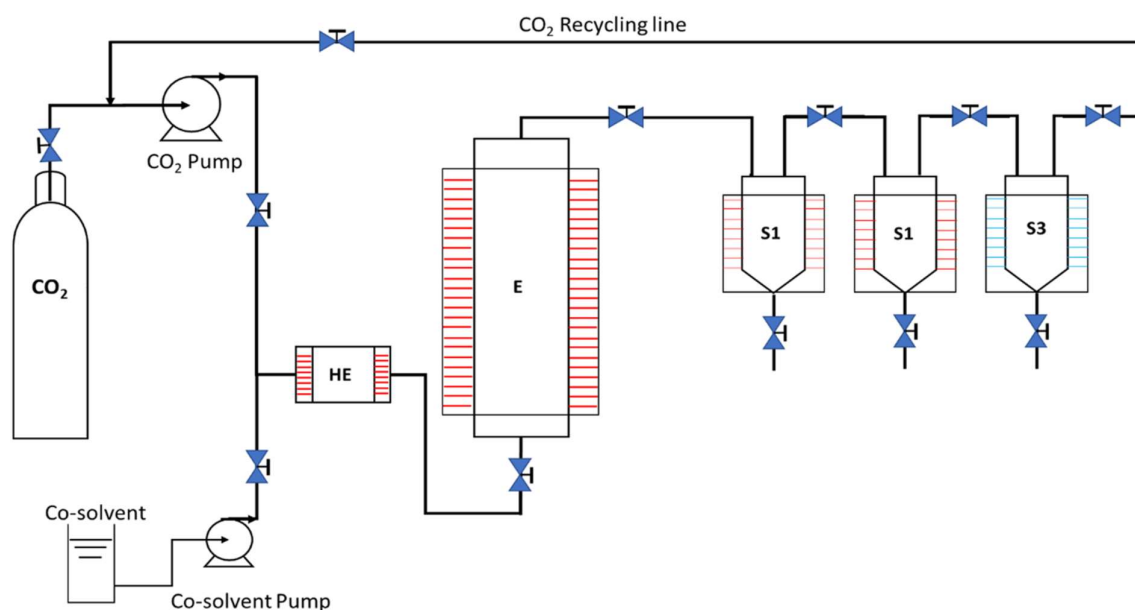

Fig. 1. Supercritical extraction experimental apparatus (SFE PROCESS, Nancy, France): (E) Extractor, (S#) Separator, (HE) Heat Exchanger.

2.4. Optimization of rosmarinic acid extraction using supercritical CO₂

2.4.1. Kinetic study of the RA extraction and effect of co-solvent percentage

The extraction kinetic of RA represents the yield of RA according to the mass of CO₂ used for a fixed mass of sage. The mass of CO₂ consumed is proportional to the extraction time; 1 kg of CO₂ is consumed every 15 min. The analysis of this curve leads to the determination of the equilibrium time, and of the corresponding mass of CO₂, required for a total extraction of the RA. Samples were taken for each kg of CO₂ consumed. A total of 16 samples were obtained and the RA content was analyzed by HPLC. The effect of the percentage of co-solvent on the extraction of RA was studied under mild conditions (350 bar, 70 °C, 50% ethanol). This percentages corresponds to the ratio between the mass of co-solvent and the mass of CO₂ used, and can have an effect on the extraction efficiency. The percentages levels investigated are 0%, 5%, 7% and 10%. High co-solvent percentages are not recommended due to insufficient CO₂ quantity in the system [16]. The co-solvent was injected into the system using a co-solvent pump at various flow rates for a total of approximately 240 min of extraction. The RA content was determined by HPLC.

2.4.2. Response surface methodology

Response surface methodology (RSM) accompanied by Box-Behnken experimental design was employed to evaluate the effects of independent variables and search for optimal extraction conditions. The box- Behnken design was built using “MODDE” software (Version 12.0.1, Sartorius, Sweden). Table 1 shows the three factors studied: pressure (100, 350, and 600 bar), temperature (40, 70, and 100 °C) and 10% (w/ w) co-solvent (0%, 50%, and 100% ethanol in water, v/v). The minimum and maximum values were chosen by performing preliminary experiments and according to data from the literature [16,31–34].

Table 1 Variables and levels used in the Box-Behnken design.

Variable code	Factor level		
	Temperature (°C)	Pressure (Bar)	Co solvent ethanol/water (v/v)
-1	40	100	0
0	70	350	50
1	100	600	100

The answers are the RA content (mg/gDM) and the antioxidant activity of the extract (mg Trolox Equivalent (TE)/gDM). Three replicates of the center point were used to provide a measure of process stability and residual variability. The experiments were performed randomly to minimize the effects of unexplained variability in observed responses due to extraneous factors. A second-order polynomial equation was used to fit the experimental data. The general form of the mathematical quadratic response equation is described (Eq. 1):

$$Y = \beta_0 + \sum_{i=1}^k \beta_i X_i + \sum_{i=1}^k \beta_{ii} X_{ii} + \sum_{i=1}^k \sum_{j=i+1}^k \beta_{ij} X_{ij} + \varepsilon \quad \text{Eq. (1)}$$

Where Y indicates the response; β_0 denotes the model intercept; β_i , β_{ii} and β_{ij} represent the coefficients of the linear, quadratic, and interactive terms, respectively; X_i and X_j are the coded independent variables; k is equal to the number of the tested factors ($k = 3$ in this study), and ε represents the residues.

2.5. Analytical measurements

2.5.1. Antioxidant activity assay

The antioxidant activity is determined using a solution of DPPH• (2,2-Diphenyl-picrylhydrazyl) at 0.06 mM and expressed in equivalent Trolox (6-hydroxy-2,5,7,8-tetramethyl-chroman-2-carboxylic acid). This measurement is determined by monitoring the decrease in absorbance at 515 nm (maximum absorbance of DPPH•). A detailed description of this measurement has already been given in the literature [35].

2.5.2. Determination of the rosmarinic acid content

Prior UHPLC analyses, the extract obtained after SC-CO₂ extraction was diluted in ethanol and filtered through a 0.20 μm Chromatofil filter, Xtra RC-20/25, with a 1 mL syringe. Rosmarinic acid was quantified by reversed-phase UHPLC-DAD (Ultimate 3000; Dionex, ThermoFisher, Illkirch, France) equipped with a quaternary pump, auto sampler, column furnace and diode array detector. A gradient elution was performed using formic acid 0.1 % in water (solvent A), acetonitrile (solvent B) on a C18 Thermo Scientific™ Accucore™ aQ; 100 × 3 mm with 2.6 μm particle size. Initial solvent was 98 % A and 2 % B. Solvent B gradient followed: 2% (0 min), 10% (3.5 min), 20% (5 min), 30% (8.5 min), 40% (10 min), 95% (11 min) and 2% (14 min). The column was maintained at 25 °C and run at a constant flow rate of 0.8 mL/min. Total run time was 15 min with a 2.5 μL injection volume, and the detection wavelength was 320 nm. Rosmarinic acid standard (≥98 %) was purchased from ThermoFisher and used to establish a calibration curve. The yield of extraction is expressed as the ratio between the amount of

extracted RA quantified by HPLC (m_{RA}) and the dry matter of the processed clary sage distillation residue ($m_{dry\ clary\ sage}$) (Eq. 2).

$$Yield\ (mg/g_{DM}) = \frac{m_{RA}}{m_{dry\ clary\ sage}} \quad Eq.\ (2)$$

2.5.3. Qualitative analysis by Liquid Chromatography–Mass Spectrometry (LC-MS) and tandem mass spectrometry

Liquid chromatography coupled to a hybrid Quadrupole/Time-Of-Flight mass spectrometer (Q-ToF) was utilized to identify the phenolic compounds in the extract. Analyses were carried out with a UHPLC chromatographic system from Agilent Technologies (Santa Clara, CA, USA) coupled with a 6545 Q-TOF mass spectrometer (Wilmington, DE, USA) equipped with ESI source ionization. A Zorbax Eclipse plus C18 (1.8 μ m, 50 \times 2.1 mm; Agilent Technologies, USA) column maintained at 40 $^{\circ}$ C was used to separate the phenolic compounds. The elution was performed using a 0.4 mL/min flowrate mobile phase composed of 0.1 % formic acid with water (A) and 0.1% formic with acetonitrile (B). The following gradient was used (A/B): 95/5 (0–1 min), 90/10 (1–3 min), 90/10 (3–8 min), 75/25 (8–12 min), 70/30 (12–13 min), 70/30 (13–15 min), 0/100 (15–17 min), 0/100 (17–19 min), 95/5 (19–20 min). The injection volume was 3 μ L. The ESI source was operated in the negative ionization mode with the following settings: capillary voltage, 3500 V; nozzle voltage, 2000 V; gas temperature, 325 $^{\circ}$ C; gas flow, 11 L/min; nebulizer, 35 psi; fragmentor, 100 V; sheath gas flow, 12 L/min; sheath gas temperature, 350 $^{\circ}$ C. Nitrogen (99.999 %) was used as the desolvation and collision gas for MS/MS. The quadrupole mass bandpass used during MS/MS precursor isolation was Medium (4 Da). The lock mass correction was applied using Agilent reference solution (m/z 966.0007) for accurate mass measurements. The scan range was m/z 50 – 1000 at 2 spectres/s. Spectra of MS/MS was obtained using the trap cell with different collision energies (10, 12, 18, 20, 30 and 32 eV). All spectra were recorded in continuous mode. Data acquisition was performed using Agilent Mass Hunter Workstation Data Acquisition B.08.00 software.

3. Results and discussion

During the optimization by a Design of Experiments (DoE) approach, some parameters are fixed in order to minimize the number of experiments. These parameters are often set at their minimum levels in order to reduce the process cost and to adapt to the technical and practical constraints of the process (solubilization limits, side reactions, safety, etc.). The extraction time or the amount of CO₂ needed for the extraction and the percentage of the co-solvent are two key parameters of the process that need to be optimized and minimized before the optimization step. Thus, in a first step, the effect of the percentage of co-solvent on the RA yield was studied and fixed as well as the CO₂ mass. Then, in a second step, the optimization of the operating conditions of the process were made by RSM.

3.1. Kinetic study of the RA extraction

The yield of RA is plotted according to the mass of CO₂ for a fixed mass of sage. The RA yield can be presented as a yield at time t (Fig. 2a) or a cumulative yield (Fig. 2b). A second abscissa is drawn, which represents the extraction time, 1 kg of CO₂ is consumed every 16 min.

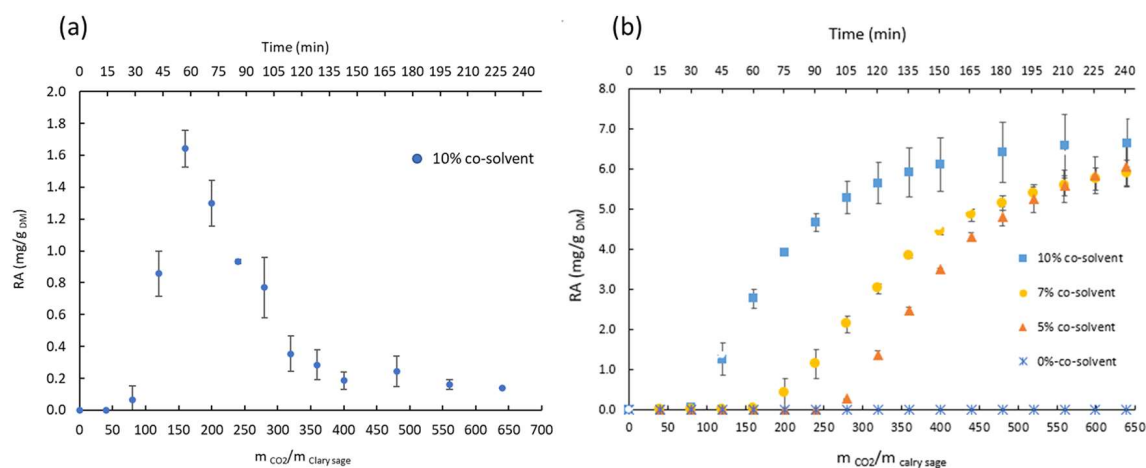

Fig. 2. Yield (a) and accumulated yield (b) of RA as a function of the specific amount of solvent ($kg_{CO_2}/kg_{clary\ sage}$) for SC- CO_2 extraction at 70°C, 350 bar and 50% ethanol with different percentages of the co-solvent.

Previous works on the application of SC- CO_2 technology in natural matrices have shown that the extraction curve is not a linear function of time but it can be divided into three periods [36–39]. In fact, the extraction process begins with a constant extraction rate (CER) period, characterized by the removal of compounds easily extractable by the solvent, mainly controlled by convective mass transfer in the fluid film around the milled particles. After the CER period, the extraction rate is reduced as a transition period begins, where the extraction rate is controlled by both convective and diffusional mass transfer mechanisms. This period is commonly called falling extraction rate (FER) period. When the solute of easy access becomes scarce in the vegetable matrix, intraparticle diffusion becomes the main mass transfer mechanism in SC- CO_2 extraction and the overall extraction curve assumes the typical shape of diffusion curve, with reduced extraction rate. This period is called diffusional period (DP) [37–39]. As shown in Fig. 2a, our extraction curve is in accordance with this description. The (CER) period was observed from 40 to 80 $m_{CO_2}/m_{clary\ sage}$ (~30 min) followed by the (FER) period from 80 to 160 $m_{CO_2}/m_{clary\ sage}$ (~60 min), and finally the (DP) from 160 $m_{CO_2}/m_{clary\ sage}$ (> 60 min). From this result, and to make sure that all the RA is extracted, the extraction time was fixed at 4 h (640 $m_{CO_2}/m_{clary\ sage}$). The extraction kinetics were plotted according three co-solvent percentages (Fig. 2b). The yield presented is cumulative. The three parts of the kinetic presented in Fig. 2a are found in Fig. 2b. A sigmoid curve is obtained with a first period without extraction, a second part where the RA is extracted and a third part of the kinetic where the maximal extraction yield is reached. According to Fig. 2b, the best extraction conditions to obtain a higher yield of RA are achieved when 10% co-solvent is used. The maximum yields obtained with 5% and 7% co-solvent were 6.10 ± 0.51 and 5.90 ± 0.31 mg/gDM, respectively. These yields were obtained at $m_{CO_2}/m_{clary\ sage}$ ratio of 640, with is equivalent to 240 min of extraction. The same yield was obtained in 135 min ($m_{CO_2}/m_{clary\ sage}$ ratio of 360) with 10% co-solvent. Extraction of RA with pure SC- CO_2 (0% co-solvent) was not feasible. Thus, for the SC- CO_2 optimization of RA, the concentration of the co-solvent was fixed at 10%.

3.2. Response surface modeling and optimization of the extraction of RA using SC-CO₂

Extraction process parameters such as pressure, temperature, solvent type and polarity have a marked influence on the release of phenolic compounds from the solid matrix during SC-CO₂, and on the antioxidant activity of the obtained extract [16]. In this study, the effect of extraction variables on RA content and antioxidant activity was investigated and the optimal conditions were identified. As shown in Table 1 (Materials and methods section), a Box-Behnken design was applied to optimize the SC-CO₂ parameters to maximize the extraction of RA and antioxidant activity from clary sage distillation extract. Table 2 presents the experimental design matrix obtained and the values of the responses at each run.

Table 2. Experimental design matrix

Run	Variable codes			Variable values			Responses	
	Temperature	Pressure	Co-solvent-ethanol/water	Temperature (°C)	Pressure (Bar)	Co-solvent-ethanol/water (v/v)	Yield (mg/g _{DM})	AA (mgTE/g _{DM})
1	0	-1	-1	70	100	0/100	5.36	18.12
2	0	-1	1	70	100	100/0	0.74	7.81
3	0	1	-1	70	600	0/100	4.08	20.54
4	0	1	1	70	600	100/0	0.00	0.97
5	-1	0	-1	40	350	0/100	4.73	15.17
6	-1	0	1	40	350	100/0	0.00	0.56
7	1	0	-1	100	350	0/100	3.23	17.35
8	1	0	1	100	350	100/0	0.000	1.02
9	-1	-1	0	40	100	50/50	7.26	22.77
10	-1	1	0	40	600	50/50	2.68	11.58
11	1	-1	0	100	100	50/50	5.90	42.78
12	1	1	0	100	600	50/50	1.91	12.27
13	0	0	0	70	350	50/50	7.57	31.00
14	0	0	0	70	350	50/50	6.76	32.59
15	0	0	0	70	350	50/50	7.12	34.76

The RA yield ranged from 0 to 7.57 mg/g_{DM} and the antioxidant activity measured by DPPH inhibition varied from 0 to 35 mg TE/g_{DM}, highlighting the considerable influence of the process variables on the evaluated RA yield and DPPH responses. The run 11 for antioxidant activity was considered an outlier and was excluded when the software processed the results. A second-order polynomial equation was used to build a mathematical model to find the optimal conditions that maximize the accumulated yield and to study the relationships between process variables and responses. The adequacy of the models was evaluated by the coefficient of determination R² (Fig. 3).

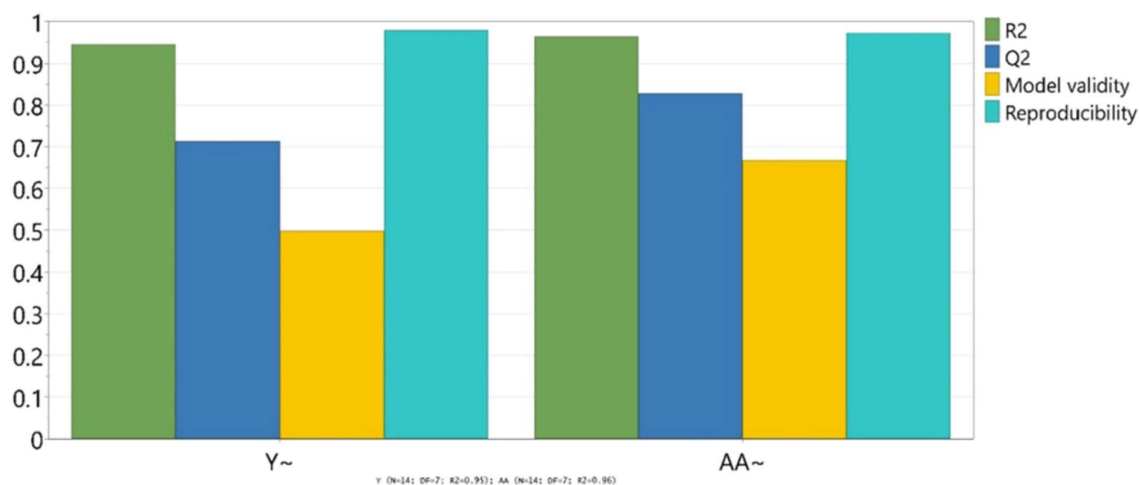

Fig. 3: summary of Fit Plot showing model fit (R^2), predictability (Q^2), model validity and reproducibility for the yield and the antioxidant activity of extracts (AA)

The summary of fit plot shown in Fig. 3 indicates a good fit of the models with an R^2 value of 0.941 and 0.964 for the yield and the antioxidant activity (AA) of extracts respectively. The R^2 is defined as the ratio of the explained variations to the total variation and is a measure of degree of adjustment. Joglekar and May (1987) reported that R^2 should be at least 0.80 for a model to be well fitted [40]. On the other hand, the lower the value of R^2 , the less relevance the dependent variables of the model will have in explaining the behavior of the variations. The Q^2 values of 0.770 (yield) and 0.828 (antioxidant activity), ideally > 0.5 , demonstrated a high predictive precision, allowing a confident prediction of the effect of changing extraction parameters on the yield of RA and the antioxidant activity of extracts. The models also demonstrated a good score for validity of 0.513 (yield) and 0.701 (antioxidant activity), far exceeding the required value of 0.25. Below this value, the validity indicates statistically significant model problems, such as the presence of outliers, an incorrect model, or a transformation problem. The reproducibility of each model is also excellent with a value of 0.979 for the cumulative yield and 0.981 for the antioxidant activity. All these statistical parameters indicate that the relationships between the variables and the responses are well described by the models.

3.2.1. Effect of SC-CO₂ parameters on the yield of extraction of rosmarinic acid

The coefficients of the equation, described in Table 3, make it possible to quantify the influence of each process factor on the extraction yield in RA.

Table 3. Coefficient table for the yield of RA extraction.

Related factors	Coefficients scaled and centered	Coefficient values	P-values
Constant	β_0	7.153	0.000
Ethanol (E)	β_1	-2.083	0.000*
Pressure (P)	β_2	-1.324	0.003*
Temperature (T)	β_3	-0.454	0.194
E*E	β_{11}	-3.527	0.000*
P*P	β_{22}	-1.080	0.050*
T*T	β_{33}	-1.635	0.008*
E*P	β_{12}	0.135	0.790
E*T	β_{13}	0.375	0.475
P*T	β_{23}	0.891	0.256

*Significant factors ($p < 0.05$)

According to Table 3, ethanol and pressure have a significant effect on RA yield. No interaction term is significant ($p > 0.05$). A quadratic effect was observed for ethanol ($p = 6.7 \cdot 10^{-5}$), temperature ($p = 0.008$) and pressure ($p = 0.050$), meaning that the effects of these parameters are not linear. The non-significant coefficients were removed to obtain a reduced model whose equation is presented below:

$$\text{Accumulated yield (mg/g}_{DM}) = 7.153 - 2.083 \times E - 1.324 \times P - 3.527 \times E \times E - 1.086 \times P \times P - 1.635 \times T \times T \text{ (Eq. 3)}$$

In order to predict the relationships between the independent and dependent variables, a 4D Contour Plot was generated from the Eq. (3) (Fig. 4). The results show an increase in the RA yield in the extract under mild conditions of temperature and pressure. The highest yield was obtained at 70 °C, 350 bar and 50% ethanol. The use of high pressure (> 420 bar) and temperature (> 85 °C) conditions induces a reduction in the extraction yield. As reported by Angelov et al., (2011) higher pressure does not affect significantly the solvent's ability to extract RA from lemon balm, therefore, considering the energy consumption, the authors suggested operating at moderate pressure (120–150 bar) [34]. The lowest yields of RA were found at high ethanol percentages (> 65%). The extraction of RA without co-solvent was not possible (Fig. 2. b) due to the low water content of the raw material (< 9%) and the non-polarity of SC-CO₂. The presence of water, at least at 10%, in the co-solvent is required to achieve a high yield of RA. However, using the co-solvent at 100% of ethanol is not favorable for the extraction of RA. The use of water–ethanol mixtures as co-solvents has been shown, by many authors, to be more efficient in extracting phenolic compounds than a mono-solvent system [19,41–46]. Hence, due to the polarity of RA, greater recovery is expected with the addition of polar co-solvents or with an intermediate polarity. Furthermore, the co-solvent may increase the density of the fluid mixture, leading to the swelling of the biomass matrix, helping to break chemical bonds and release soluble compounds [47], thus improving internal diffusion and the solubilization of various classes of compounds [48–50].

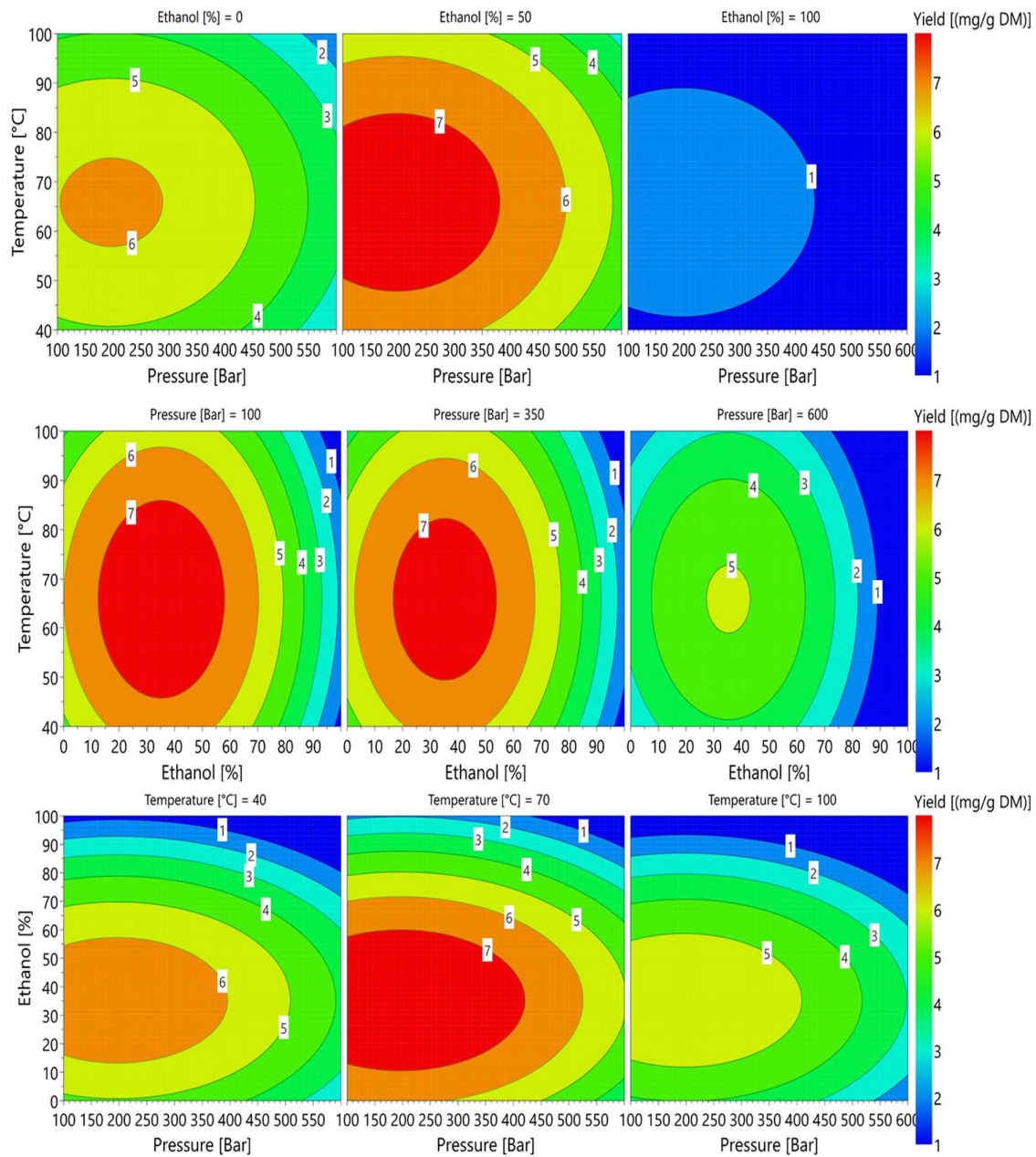

Fig.4. Response 4D Contour Plot showing combined effects of temperature, pressure and ethanol percentage in co-solvent on the extraction yield of RA.

The best conditions for RA extraction were found to be in the range of 100–420 bar, 40–85 °C, and 15–55% ethanol (v ethanol/ v water) as co-solvent.

3.2.2. Effect of SC-CO₂ parameters on the antioxidant activity of extracts

The previous design of experiments is used to predict the antioxidant activity of the extract. Table 4 presents the values of the coefficients associated with each term.

Table 4. Coefficient table for antioxidant activity of extracts.

Related factors	Coefficients scaled and centered	Coefficient values	P-value
Constant	β_0	32.783	0.000
Ethanol (E)	β_1	-7.603	0.000*
Pressure (P)	β_2	-2.828	0.046*
Temperature (T)	β_3	-0.019	0.987
E*E	β_{11}	-14.437	0.000*
P*P	β_{22}	-6.486	0.005*
T*T	β_{33}	-9.821	0.001*
E*P	β_{12}	-2.315	0.168
E*T	β_{13}	-0.430	0.770
P*T	β_{23}	2.088	0.344

*Significant factors ($p < 0.05$)

Ethanol and pressure have a significant effect on the antioxidant activity of extracts. The quadratic terms of ethanol, pressure and temperature are significant ($p < 0.05$). The reduced predictive equation for the DPPH scavenging activity of the extracts can be formulated as:

$$\begin{aligned}
 & \text{Antioxidant activity (mg TE/g}_{DM}) \\
 & = 32.783 - 7.603 \times E - 2.828 \times P - 14.437 \times E \times E - 6.486P \times P - 9.821 \times T \times T \quad (\text{Eq. 4})
 \end{aligned}$$

The response 4D Contour Plot combining effects of temperature, pressure and ethanol percentage in co-solvent on the antioxidant activity of extracts are presented in Fig. 5.

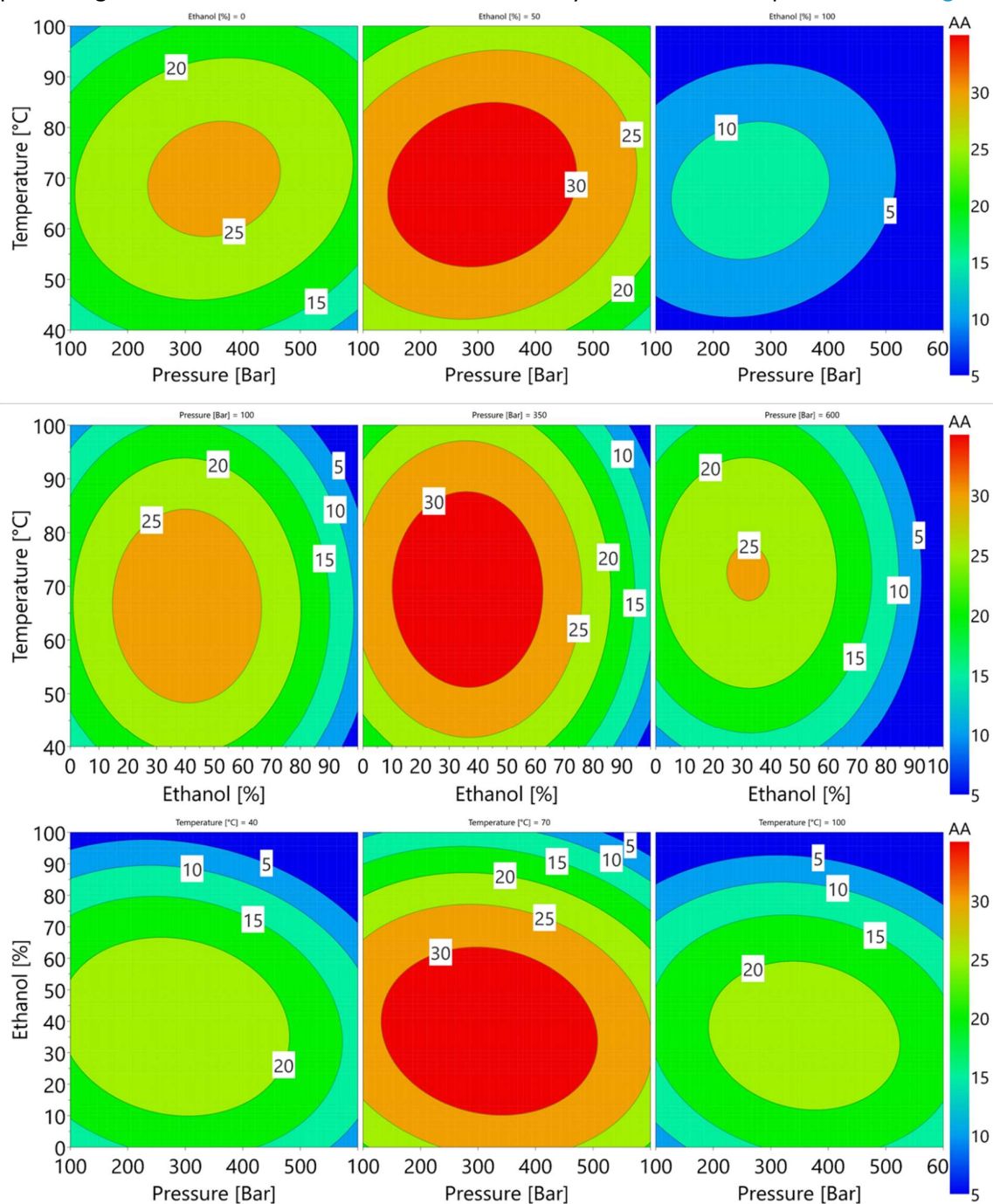

Fig.5. Response 4D Contour Plot showing combined effects of temperature, pressure and ethanol percentage in co-solvent on the antioxidant activity of the extract.

The 4D contour plotted in Fig. 5 reveals that the DPPH scavenging activity of SC-CO₂ extracts is affected by the extraction process variables in a similar pattern to that observed for RA yield (Fig. 4). The extraction temperature has a non-linear effect on the antioxidant activity. The maximum values were obtained at the temperature range 55–85 °C. Ethanol and pressure

have also shown a non-linear effect on the antioxidant activity, the highest values were obtained at 15–60% ethanol and 150–500 bar respectively. At constant pressure, the antioxidant activity rises with the increase in the percentage of ethanol and approaches its maximum values at percentages between 15% and 60%. At a high percentage of ethanol, the antioxidant activity decreases considerably and reaches a minimum (< 5 mg TE/g DM) at 100% ethanol. The correlation between the antioxidant activity of the extracts and their yield of rosmarinic acid was plotted (Fig. 6A).

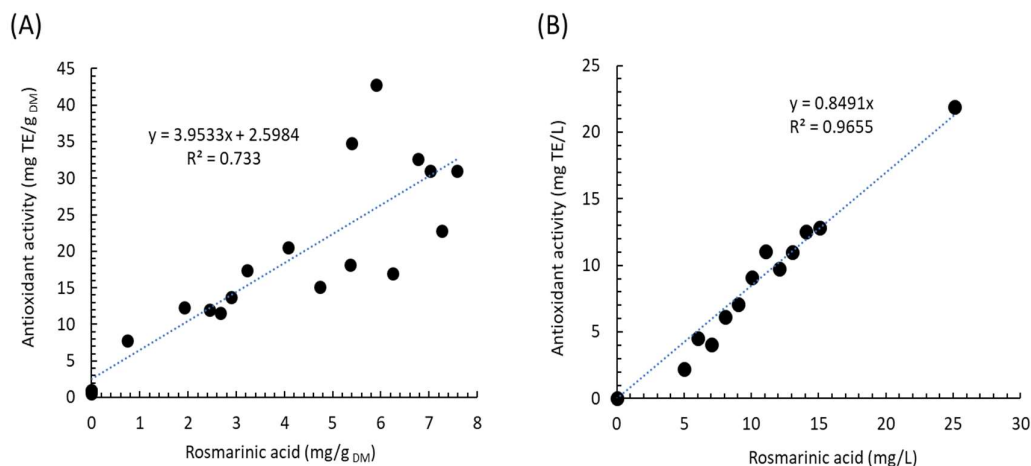

Fig.6. Scatter plots of: (A) the antioxidant activity of extracts versus the yield of rosmarinic acid and (B) the antioxidant activity of model solutions of pure RA in ethanol

A significant positive correlation ($R^2 = 0.733$) was observed for the extracts (Fig. 6A) indicating that RA is one of the main antioxidant molecules of sage extracts. Nevertheless, the relationship between the concentrations in ethanol (Fig. 6B). The results have shown a high correlation ($R^2 = 0.965$) between the concentration of the pure RA and the antioxidant activity of the solutions. Liquid chromatography in line with mass spectrometry (LC-MS) was used to identify phenolic compounds in the extract (Fig. 7). Fig. 7 shows the base peak chromatogram of the extract. Treatment of the data revealed the occurrence of 13 known compounds in the distillation residue of clary sage.

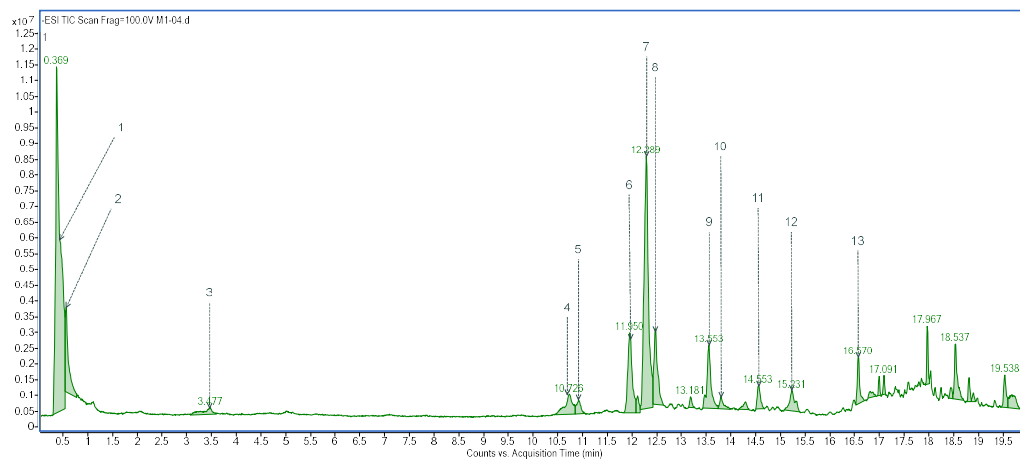

Fig.7. Base peak chromatogram of extract obtained by LC-QTOF-MS/MS

Data on these 13 compounds, including the measured m/z [M-H]⁻ values, calculated m/z , calculated mass, calculated mass error, retention time (RT min) are presented in Table 5.

Table 5. Characterization of polyphenolic compounds of clary sage by LC-QTOF-MS/MS

Peak	Proposed compounds	Molecular formula	RT (min)	Ionization mode (ESI-)	Theoretical (m/z)	Observed (m/z)	Mass Error	MS/MS (product ions)
1	Malic acid ¹	C ₄ H ₆ O ₅	0.402	[M-H] ⁻	133.0142	133.0154	1.2 mDa	115, 89, 71
2	Fumaric acid ¹	C ₄ H ₄ O ₄	0.576	[M-H] ⁻	115.0037	115.0048	1.1 mDa	71
3	Caffeic acid ¹	C ₉ H ₈ O ₄	3.477	[M-H] ⁻	179.0350	179.0358	-0.8 mDa	135
4	Luteolin-7-O-glucuronide / Luteolin-3-O-glucuronide ²	C ₂₁ H ₁₈ O ₁₂	10.723	[M-H] ⁻	461.0725	461.0732	-1.5 ppm	285
5	Luteolin-7-O-glucoside ²	C ₂₁ H ₂₀ O ₁₁	10.905	[M-H] ⁻	447.0933	447.0942	-2.0 ppm	285
6	Apigenin-7-O-glucuronide ²	C ₂₁ H ₁₈ O ₁₁	11.956	[M-H] ⁻	445.0776	445.0775	0.2 ppm	269, 175, 113
7	Rosmarinic acid ¹	C ₁₈ H ₁₆ O ₈	12.287	[M-H] ⁻	359.0772	359.0788	-4.4 ppm	197, 179, 161, 135
8	Luteolin-7-O-glucuronide / Luteolin-3-O-glucuronide ²	C ₂₁ H ₁₈ O ₁₂	12.461	[M-H] ⁻	461.0725	461.0725	0.0 ppm	285
9	Luteolin ¹	C ₁₅ H ₁₀ O ₆	13.554	[M-H] ⁻	285.0405	285.0403	0.7 ppm	199, 175, 151, 133, 107
10	Isorhamnetin ²	C ₁₆ H ₁₂ O ₇	13.794	[M-H] ⁻	315.051	315.0516	-1.9 ppm	300
11	Apigenin ¹	C ₁₅ H ₁₀ O ₅	14.553	[M-H] ⁻	269.0455	269.0452	-1.1 ppm	151, 117, 107
12	3,7-Dimethylquercetin ²	C ₁₇ H ₁₄ O ₇	15.231	[M-H] ⁻	329.0667	329.0669	-0.6 ppm	314, 299
13	Cirsimaritin ²	C ₁₇ H ₁₄ O ₆	16.570	[M-H] ⁻	313.0718	313.0713	-1.6 ppm	298, 283

¹ Identification confirmed using commercial standards by LC-QTOF-MS/MS

² Compounds characterized without commercial standards by LC-QTOF-MS/MS

The 13 identified compounds correspond to 2 dicarboxylic acids and 11 phenolic compounds. The assignment of the corresponding peaks to malic acid, fumaric acid, caffeic acid, rosmarinic

acid, luteolin and apigenin was possible through the retention time, the accurate mass and the fragments obtained by MS/MS. Indeed, these peaks had the same retention times, identical accurate masses and the same fragmentation pattern as their respective standards. For the other compounds for which there were no standards, the identification was made based on the precise mass of the molecular ion [M-H]⁻ and on the fragment ions. These fragments were then compared to some compounds described in the literature with the same precise mass. The molecular ions [M-H]⁻ at *m/z* 461.07 with retention times 10.735 and 12.47 min could be luteolin-7-O-glucuronide and luteolin-3-O-glucuronide or vice versa. Indeed, the fragment obtained at *m/z* 285 (corresponding to the loss of the glucuronide group by the precursor ion) was reported by Hossain et al. in 2010 [54] and Ali et al. in 2021 [55] during the fragmentation of Luteolin-3-O-glucuronide and Luteolin-7-O-glucuronide. For molecular ions [M-H]⁻ at *m/z* 447.09, 445.07, 315.05, 329.06 and 313.07, Hossain et al. and Akhtar et al. reported the same fragmentation patterns as those present in Table 5 during the analyses of luteolin-7-O-glucoside, apigenin-7-O-glucuronide, isorhamnetin, 3,7-dimethylquercetin and cirsimaritin respectively. From these results, these names were assigned to the respective molecular ions. However, the analysis of the standards of these compounds would remove any doubt. The most identified compounds in the extracts are known to have antioxidant activities [55]. Hence, these compounds contribute to the antioxidant activity of the extracts in addition to rosmarinic acid which is the major component.

3.3. Validation of the prediction models

The maximum yield in RA predicted by the model is 7.73 mg/gDM. This theoretical yield was obtained at 35% ethanol, 100 bar and 65 °C. In these conditions, the antioxidant activity of the extract is 27.5 mg TE/g DM. To validate the prediction model, an extraction was carried out in the same conditions, the yield of RA and the antioxidant activity of the extracts were investigated. The results are shown in Fig. 8.

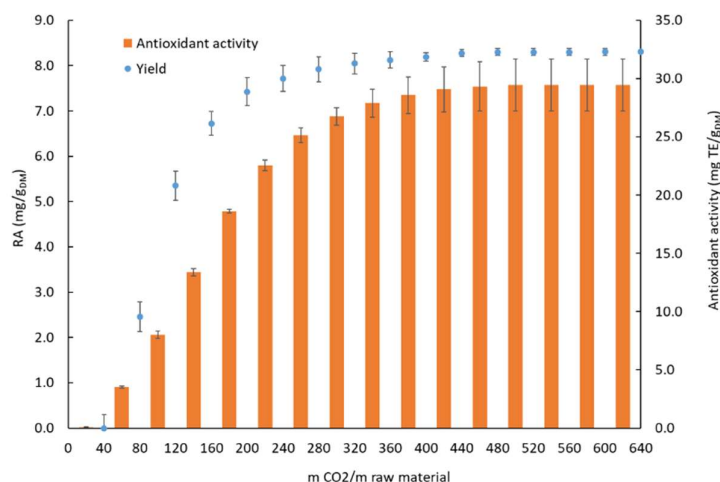

Fig. 8. Extraction kinetic of RA and evolution of the antioxidant activity of the extracts obtained in the best conditions: 35% ethanol, 100 bars and 65 °C.

The maximum experimental yield of RA and antioxidant activity of extracts obtained were 8.30 ± 0.080 mg/gDM and 29.07 ± 0.10 mg TE/ gDM which represents 107% and 105% of the

predicted values of the yield and the antioxidant activity respectively. These percentages are considered satisfactory and confirm the predictability of the models. Moreover, the yield obtained corresponds to the extraction of the total amount of RA present in the distillation residue of clary sage (8.346 ± 0.918 mg/g DM). The kinetic study allowed to find the optimal mCO₂/mclary sage ratio (duration) at the optimal extraction conditions. Both results were obtained at mCO₂/mclary sage ratio of 440 (165 min) which is considered as an important reduction of time and the amount of CO₂ required for the extraction. The amount of CO₂ and co-solvent consumed is still high compared to conventional extraction. To further reduce these two parameters and reduce the extraction cost, it would be interesting in a future stage to optimize other operating factors such as CO₂ flow rate, biomass particle size and pretreatment.

4. Conclusion

This work showed the feasibility of using SC-CO₂ to obtain extracts rich in rosmarinic acid from clary sage distillation residue. The results confirm that the presence of water and ethanol as co-solvent is essential to obtain an extract rich in rosmarinic acid with high antioxidant activity. The effects of SC-CO₂ extraction parameters on antioxidant activity and the extraction yield of RA are similar. The best yields of rosmarinic acid and antioxidant activities of the extracts were obtained under the conditions of 100–420 bar, 40–85 °C, and 15–55% ethanol co-solvent. The correlation between rosmarinic acid amount and antioxidant activity is high, suggesting that rosmarinic acid is responsible for the bioactivity of the SC-CO₂ extracts. Nevertheless, the findings also reveal that other compounds can affect, positively or negatively, the antioxidant activity of the extracts. Clary sage distillation residue extracts obtained by SC-CO₂ present a high antiradical potential and may be used as natural source of rosmarinic acid in functional foods, in the cosmetics and in pharmaceutical industry. Supercritical extraction with co-solvent can be added as an additional step after the extraction of essential oil from clary sage for a total and more sustainable recovery of the soluble polar and non-polar soluble compounds of clary sage.

Declaration of Competing Interest The authors declare that they have no known competing financial interests or personal relationships that could have appeared to influence the work reported in this paper.

Data Availability No data was used for the research described in the article.

Acknowledgements The authors gratefully acknowledge the financial support the Region Grand Est, France, the Conseil Départemental de la Marne, France and the Grand Reims, France, as well as the French research institute for perfume, medicinal and aromatic plants for providing the raw material.

References

- [1] C. Schmiderer, P. Grassi, J. Novak, M. Weber, C. Franz, Diversity of essential oil glands of clary sage (*Salvia sclarea* L., Lamiaceae), *Plant Biol. Stuttg. Ger.* 10 (2008) 433–440, <https://doi.org/10.1111/j.1438-8677.2008.00053.x>.
- [2] I. Jasicka-Misiak, A. Poliwoda, M. Petecka, O. Buslovych, V.A. Shlyapnikov, P. P. Wieczorek, Antioxidant phenolic compounds in *Salvia officinalis* L. and *Salvia sclarea* L, *Ecol. Chem. Eng. S* 25 (2018) 133–142, <https://doi.org/10.1515/eces-2018-0009>.
- [3] Y. Kan, A. Gökbulut, M. Kartal, B. Konuklugil, G. Yilmaz, Development and validation of a LC method for the analysis of phenolic acids in Turkish salvia species, *Chromatographia* 66 (2007) S147–S152, <https://doi.org/10.1365/s10337-007-0278-7>.
- [4] O. Yesil-Celiktas, C. Sevimli, E. Bedir, F. Vardar-Sukan, Inhibitory effects of rosemary extracts, carnosic acid and rosmarinic acid on the growth of various human cancer cell lines, *Plant Foods Hum. Nutr.* 65 (2010) 158.
- [5] L. Boyadzhiev, V. Dimitrova, Extraction and liquid membrane preconcentration of rosmarinic acid from lemon balm (*Melissa officinalis* L.), *Sep. Sci. Technol.* 41 (2006) 877–886, <https://doi.org/10.1080/01496390600588697>.
- [6] M. Wang, J. Li, M. Rangarajan, Y. Shao, E.J. LaVoie, T.-C. Huang, C.-T. Ho, Antioxidative phenolic compounds from sage (*Salvia officinalis*), *J. Agric. Food Chem.* 46 (1998) 4869–4873, <https://doi.org/10.1021/jf980614b>.
- [7] B. Zelić, M. Hadolin, D. Bauman, D. Vasic-Racki, Recovery and purification of rosmarinic acid from rosemary using electrodialysis, *Acta Chim. Slov.* 52 (2005).
- [8] K. Esmailzadeh-Salestani, Effects of iron ions on rosmarinic acid production and antioxidant system in *Melissa officinalis* L. Seedlings, *Annu. Res. Rev. Biol.* 4 (2014) 3359–3372, <https://doi.org/10.9734/ARRB/2014/9300>.
- [9] N. Öztürk, M. Tuncel, U. Uysal, E.M. Oncu Kaya, O. Koyuncu, Determination of Rosmarinic acid by high-performance liquid chromatography and its application to certain salvia species and rosemary, *FOOD Anal. Methods - FOOD Anal. Method* 4 (2011) 300–306, <https://doi.org/10.1007/s12161-010-9164-2>.
- [10] M. Shekarchi, H. Hajimehdipoor, S. Saeidnia, A.R. Gohari, M.P. Hamedani, Comparative study of rosmarinic acid content in some plants of labiatae family, *Pharmacogn. Mag.* 8 (2012) 37–41, <https://doi.org/10.4103/0973-1296.93316>.
- [11] O.R. Alara, N.H. Abdurahman, C.I. Ukaegbu, Extraction of phenolic compounds: a review, *Curr. Res. Food Sci.* 4 (2021) 200–214, <https://doi.org/10.1016/j.crfs.2021.03.011>.
- [12] J.F. Osorio-Tobón, Recent advances and comparisons of conventional and alternative extraction techniques of phenolic compounds, *J. Food Sci. Technol.* 57 (2020) 4299–4315, <https://doi.org/10.1007/s13197-020-04433-2>.
- [13] Soto-Hernández, M.; García-Mateos, R.; Palma-Tenango, M. *Plant Physiological Aspects of Phenolic Compounds*; BoD – Books on Demand, 2019. ISBN 978-1- 78984-033-9.
- [14] Q.-W. Zhang, L.-G. Lin, W.-C. Ye, Techniques for extraction and isolation of natural products: a comprehensive review, *Chin. Med.* 13 (2018) 20, <https://doi.org/10.1186/s13020-018-0177-x>.

- [15] Z. Ahmadian-Kouchaksaraie, R. Niazmand, Supercritical carbon dioxide extraction of antioxidants from crocus sativus petals of saffron industry residues: optimization using response surface methodology, *J. Supercrit. Fluids* 121 (2017) 19–31, <https://doi.org/10.1016/j.supflu.2016.11.008>.
- [16] K. Ty'skiewicz, M. Konkol, E. R'oj, The application of supercritical fluid extraction in phenolic compounds isolation from natural plant materials, *Mol. J. Synth. Chem. Nat. Prod. Chem.* 23 (2018), <https://doi.org/10.3390/molecules23102625>.
- [17] R.N. Almeida, R.G. Neto, F.M.C. Barros, E. Cassel, G.L. von Poser, R.M.F. Vargas, Supercritical extraction of hypericum caprifoliatum using carbon dioxide and ethanol+water as Co-solvent, *Chem. Eng. Process. Process. Intensif.* 70 (2013) 95–102, <https://doi.org/10.1016/j.cep.2013.05.002>.
- [18] C. Da Porto, A. Natolino, D. Decorti, Extraction of proanthocyanidins from grape marc by supercritical fluid extraction using CO₂ as solvent and ethanol–water mixture as Co-solvent, *J. Supercrit. Fluids* 87 (2014) 59–64, <https://doi.org/10.1016/j.supflu.2013.12.013>.
- [19] Y.M. Monroy, R.A.F. Rodrigues, A. Sartoratto, F.A. Cabral, Influence of ethanol, water, and their mixtures as co-solvents of the supercritical carbon dioxide in the extraction of phenolics from purple Corn Cob (*Zea mays* L.), *J. Supercrit. Fluids* 118 (2016) 11–18, <https://doi.org/10.1016/j.supflu.2016.07.019>.
- [20] Y.L. Ngo, C.H. Lau, L.S. Chua, Review on rosmarinic acid extraction, fractionation and its anti-diabetic potential, *Food Chem. Toxicol.* 121 (2018) 687–700, <https://doi.org/10.1016/j.fct.2018.09.064>.
- [21] G. Peev, P. Penchev, D. Peshev, G. Angelov, Solvent extraction of rosmarinic acid from lemon balm and concentration of extracts by nanofiltration: effect of plant pre-treatment by supercritical carbon dioxide, *Chem. Eng. Res. Des.* 89 (2011) 2236–2243, <https://doi.org/10.1016/j.cherd.2011.04.014>.
- [22] A. Wüst Zibetti, A. Aydi, M. Arauco Livia, A. Bolzan, D. Barth, Solvent extraction and purification of rosmarinic acid from supercritical fluid extraction fractionation waste: economic evaluation and scale-up, *J. Supercrit. Fluids* 83 (2013) 133–145, <https://doi.org/10.1016/j.supflu.2013.09.005>.
- [23] T. Lefebvre, E. Destandau, E. Lesellier, Sequential extraction of carnosic acid, rosmarinic acid and pigments (Carotenoids and Chlorophylls) from rosemary by online supercritical fluid extraction-supercritical fluid chromatography, *J. Chromatogr. A* 1639 (2021), 461709, <https://doi.org/10.1016/j.chroma.2020.461709>.
- [24] R. Laville, C. Castel, K. Fattarsi, C. Roy, L. Legendre, C. Delbecque, P.-P. Garry, A. Audran, X. Fernandez, Low sclareol by-product of clary sage concrete: chemical analysis of a waste product of the perfume industry, *Flavour Fragr. J.* 28 (2013) 93–101, <https://doi.org/10.1002/ffj.3133>.
- [25] C. Dufour, *Le Fractionnement Supercritique Appliquée à des Composés d'intérêt Industriel*. These de doctorat, Aix-Marseille, 2017.
- [26] C. Bakó, V.L. Balázs, G. Takács, J.P. Pallos, S. Pál, B. Kocsis, D.R. Petho, G. Horváth, Combination of analytical and statistical methods in order to optimize antibacterial activity of clary sage supercritical fluid extracts, *Molecules* 26 (2021) 6449, <https://doi.org/10.3390/molecules26216449>.
- [27] E. Ronyai, B. Simandi, E. Lemberkovics, T. Veress, D. Patiaka, Comparison of the volatile composition of clary sage oil obtained by hydrodistillation and supercritical fluid extraction, *J. Essent. Oil Res.* 11 (1999) 69–71, <https://doi.org/10.1080/10412905.1999.9701074>.

- [28] V. Sulnute, R. Baranauskienė, O. Ragazinskiene, P.R. Venskutonis, Comparison of composition of volatile compounds in ten salvia species isolated by different methods, *Flavour Fragr. J.* 32 (2017) 254–264, <https://doi.org/10.1002/ffj.3389>.
- [29] A.H. Abdul Aziz, N. Idrus, N. Putra, M. Awang, Z. Idham, H. Mamat, M. Yunus, Solubility of rosmarinic acid in supercritical carbon dioxide extraction from orthosiphon stamineus leaves, *ChemEngineering* 6 (2022) 59, <https://doi.org/10.3390/chemengineering6040059>.
- [30] L.R. Snyder, Classification of the solvent properties of common liquids, *J. Chromatogr. A* 92 (1974) 223–230, [https://doi.org/10.1016/S0021-9673\(00\)85732-5](https://doi.org/10.1016/S0021-9673(00)85732-5).
- [31] R.N. Carvalho, L.S. Moura, P.T.V. Rosa, M.A.A. Meireles, Supercritical fluid extraction from rosemary (*Rosmarinus officinalis*): kinetic data, extract's global yield, composition, and antioxidant activity, *J. Supercrit. Fluids* 35 (2005) 197–204, <https://doi.org/10.1016/j.supflu.2005.01.009>.
- [32] O.Y. Celiktaş, E. Bedir, F.V. Sukan, In vitro antioxidant activities of rosmarinus officinalis extracts treated with supercritical carbon dioxide, *Food Chem.* 101 (2007) 1457–1464, <https://doi.org/10.1016/j.foodchem.2006.03.055>.
- [33] A. Sánchez-Camargo, P. del, A. Valdés, G. Sullini, V. García-Cañas, A. Cifuentes, E. Ibáñez, M. Herrero, Two-step sequential supercritical fluid extracts from rosemary with enhanced anti-proliferative activity, *J. Funct. Foods* 11 (2014) 293–303, <https://doi.org/10.1016/j.jff.2014.10.014>.
- [34] G. Angelov, P. Penchev, J.-S. Condoret, Extraction of rosmarinic acid from botanicals with supercritical carbon dioxide. Effect of the modifiers added to the solvent, *Comptes Rendus Acad. Bulg. Sci.* 64 (2011) 953–958.
- [35] M. Chadni, E. Isidore, E. Diemer, O. Ouguir, F. Brunois, R. Catteau, L. Cassan, I. Ioannou, Optimization of extraction conditions to improve chlorogenic acid content and antioxidant activity of extracts from forced Witloof Chicory Roots, *Foods* 11 (2022) 1217, <https://doi.org/10.3390/foods11091217>.
- [36] C.L.C. Albuquerque, M.A.A. Meireles, Defatting of annatto seeds using supercritical carbon dioxide as a pretreatment for the production of bixin: experimental, modeling and economic evaluation of the process, *J. Supercrit. Fluids* 66 (2012) 86–95, <https://doi.org/10.1016/j.supflu.2012.01.004>.
- [37] S. Mazzutti, C.A.S. Riehl, E. Ibáñez, S.R.S. Ferreira, Green-based methods to obtain bioactive extracts from plantago major and Plantago lanceolata, *J. Supercrit. Fluids* 119 (2017) 211–220, <https://doi.org/10.1016/j.supflu.2016.09.018>.
- [38] J.H. de O. Reis, B.A.S. Machado, G. de A. Barreto, J.P. dos Anjos, L.M. dos S. Fonseca, A.A.B. Santos, F.L.P. Pessoa, J.I. Druzian, Supercritical extraction of red propolis: operational conditions and chemical characterization, *Molecules* 25 (2020) 4816, <https://doi.org/10.3390/molecules25204816>.
- [39] F. Salinas, R. Vardanega, C. Espinosa-Alvarez, D. Jimenez, W.B. Muñoz, M.C. Ruiz-Domínguez, M.A.A. Meireles, P. Cerezal-Mezquita, Supercritical fluid extraction of Chañar (*Geoffroea decorticans*) almond oil: global yield, kinetics and oil characterization, *J. Supercrit. Fluids* 161 (2020), 104824, <https://doi.org/10.1016/j.supflu.2020.104824>.
- [40] A. Joglekar, A.T. May, *Product excellence through design of experiments*, Undefined (1987).
- [41] C. Da Porto, D. Decorti, A. Natolino, Water and ethanol as Co-solvent in supercritical fluid extraction of proanthocyanidins from Grape Marc: a comparison and a proposal, *J. Supercrit. Fluids* 87 (2014) 1–8, <https://doi.org/10.1016/j.supflu.2013.12.019>.

- [42] J.T. Paula, L.C. Paviani, M.A. Foglio, I.M.O. Sousa, F.A. Cabral, Extraction of anthocyanins from *Arrabidaea chica* in Fixed Bed Using CO₂ and CO₂/ethanol/ water mixtures as solvents, *J. Supercrit. Fluids* 81 (2013) 33–41, [https://doi.org/ 10.1016/j.supflu.2013.04.009](https://doi.org/10.1016/j.supflu.2013.04.009).
- [43] I.J. Seabra, M.E.M. Braga, M.T. Batista, H.C. de Sousa, Effect of solvent (CO₂/ Ethanol/H₂O) on the fractionated enhanced solvent extraction of anthocyanins from elderberry pomace, *J. Supercrit. Fluids* 54 (2010) 145–152, [https://doi.org/ 10.1016/j.supflu.2010.05.001](https://doi.org/10.1016/j.supflu.2010.05.001).
- [44] M. Solana, I. Boschiero, S. Dall'Acqua, A. Bertucco, A comparison between supercritical fluid and pressurized liquid extraction methods for obtaining phenolic compounds from *Asparagus officinalis* L, *J. Supercrit. Fluids* 100 (2015) 201–208, <https://doi.org/10.1016/j.supflu.2015.02.014>.
- [45] E.E. Yilmaz, E.B. Ozvural, H. Vural, Extraction and identification of proanthocyanidins from grape seed (*Vitis vinifera*) using supercritical carbon dioxide, *J. Supercrit. Fluids* 55 (2011) 924–928, [https://doi.org/10.1016/j. supflu.2010.10.046](https://doi.org/10.1016/j.supflu.2010.10.046).
- [46] Z.D. Zulkafli, H. Wang, F. Miyashita, N. Utsumi, K. Tamura, Cosolvent-modified supercritical carbon dioxide extraction of phenolic compounds from bamboo leaves (*Sasa palmata*), *J. Supercrit. Fluids* 94 (2014) 123–129, <https://doi.org/10.1016/j. supflu.2014.07.008>.
- [47] J. Paes, R. Dotta, G.F. Barbero, J. Martínez, Extraction of phenolic compounds and anthocyanins from blueberry (*Vaccinium myrtillus* L.) residues using supercritical CO₂ and pressurized liquids, *J. Supercrit. Fluids* 95 (2014) 8–16, [https://doi.org/ 10.1016/j.supflu.2014.07.025](https://doi.org/10.1016/j.supflu.2014.07.025).