



HAL
open science

Towards an in situ product recovery of bio-based 3-hydroxypropionic acid: influence of bioconversion broth components on membrane-assisted reactive extraction

Florian Chemarin, Violaine Athès, Magali Bedu, Thomas Loty, Florent Allais, Ioan-Cristian Trelea, Marwen Moussa

► To cite this version:

Florian Chemarin, Violaine Athès, Magali Bedu, Thomas Loty, Florent Allais, et al.. Towards an in situ product recovery of bio-based 3-hydroxypropionic acid: influence of bioconversion broth components on membrane-assisted reactive extraction. *Journal of Chemical Technology and Biotechnology*, 2019, 94 (3), pp.964-972. 10.1002/jctb.5845 . hal-02561218

HAL Id: hal-02561218

<https://agroparistech.hal.science/hal-02561218>

Submitted on 8 May 2020

HAL is a multi-disciplinary open access archive for the deposit and dissemination of scientific research documents, whether they are published or not. The documents may come from teaching and research institutions in France or abroad, or from public or private research centers.

L'archive ouverte pluridisciplinaire **HAL**, est destinée au dépôt et à la diffusion de documents scientifiques de niveau recherche, publiés ou non, émanant des établissements d'enseignement et de recherche français ou étrangers, des laboratoires publics ou privés.

Towards an *in situ* product recovery of bio-based 3-hydroxypropionic acid: influence of bioconversion broth components on membrane-assisted reactive extraction

Florian Chemarin^{a,b}, Violaine Athès^b, Magali Bedu^c, Thomas Loty^{a,b}, Florent Allais^{a,b}, Ioan Cristian Trelea^b, Marwen Moussa^{b*}

^a AgroParisTech, Chaire Agro-Biotechnologies Industrielles (ABI), Centre Européen de Biotechnologie et Bioéconomie (CEBB), F-51110 Pomacle, France

^b UMR GMPA, AgroParisTech, INRA, Université Paris-Saclay, F-78850, Thiverval-Grignon, France

^c UMR GENIAL, AgroParisTech, INRA, Université Paris-Saclay, F-91300, Massy, France

* Corresponding author: marwen.moussa@agroparistech.fr, phone number: +33 (0)1 30 81 54 39

Abstract:

BACKGROUND: Bioconversion broths are complex media with microorganisms that convert substrates into products in the presence of salts and nitrogen sources and that may release biomolecules. This paper deals with the impact of bioconversion broth components on the membrane-based reactive extraction of 3-hydroxypropionic acid (3-HP), by tri-*n*-octylamine (TOA) in *n*-decanol in preparation for an *in-situ* product recovery. We focus here on the influence of 3-HP concentration (0.5 – 10 g/L), initial pH of the solution (3 – 5), presence of proteins and salts on the extraction yields and kinetics.

RESULTS: It was found that reducing the initial acid concentration caused an acceleration of the extraction kinetics because of a higher extent of complexation with TOA. pH effects were dramatic as enhancing the pH from 3 to 5 decreased the extraction yield from 74 to only 5% due to acid dissociation. Proteins were shown to have negligible impact on the extraction yield and kinetics probably because of their negligible mass transfer resistance at the liquid-liquid interface compared to the membrane. Conversely, the presence of salts (KCl and KH₂PO₄) was highly detrimental. The decrease of the extraction yield was shown to be due to an anion exchange between the carboxylate

anion of 3-HP in the organic phase and the anion of the salt in the aqueous phase. Chloride ions were more impacting than the biphosphate ions.

CONCLUSION: These results give valuable information for the implementation of a membrane-based reactive extraction as an in-situ product recovery process, suggesting recommendations for bioconversion tuning.

Keywords: tri-*n*-octylamine, reactive extraction, organic acid, bioconversion broth

Introduction

Within the actual trend of the bioeconomy development, bio-based platform molecules such as 3-hydroxypropionic acid (3-HP) are widely investigated. Indeed, the American department of energy ranked 3-HP among the top 10 value-added chemicals from biomass¹. It is seen as a potential precursor for a large set of chemicals like polyesters, acrylic acid and derivatives. The main routes studied for the production of 3-hydroxypropionic acid are biotechnological conversions of bio-sourced substrates like glycerol or glucose.

Several examples of organic acids bioproduction were shown to be limited because of the inhibitory effects of the produced molecules. The case of inhibition during 3-HP production has been reported², and recently studied regarding a *L. reuterii* strain producing 3-HP from glycerol³. Indeed, toxicity was shown to be due to an intermediate (3-hydroxypropionaldehyde) and the final product (3-HP) accumulations. The intermediate can be prevented in optimal fed-batch conditions⁴ while the toxicity of the final product could be reduced by extracting it continuously.

This latter strategy to improve performances through the removing of the acid from the bioconversion medium as soon as it is produced is called *In Situ* Product Recovery (ISPR). Instead of neutralizing 3-HP with a base in the broth, the reactivity of the acidic group of 3-HP can be used to remove selectively the acid from the broth using reactive extraction⁵. This consists in reacting the acid in the aqueous phase with an extractant, present in an organic phase. The product of the reaction is a reversible complex soluble in the organic phase. As for similar acids like pyruvic⁶ or lactic acids⁷, a good extraction system for 3-HP is tri-*n*-octylamine (TOA) in *n*-decanol (decanol). Indeed, we previously showed that the solvating power of decanol leads to high extraction yields⁸. In this system, the main reaction occurring is:

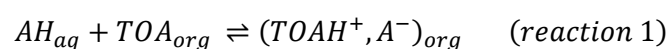

To implement the extraction as an *in-situ* product recovery technique, membrane contactors seem very attractive as already reported in previous publications of extractive fermentations of organic acids^{9,10}.

The extraction mechanisms of 3-HP by TOA in decanol have been investigated in a previous study, demonstrating the formation of a (1:1) stoichiometry complex. It means that one molecule of 3-HP reacts with one molecule of TOA resulting in an ion pair solvated by decanol and water in the organic phase¹¹. However, in real conditions of extraction from bioconversion media, the initial aqueous phase is a complex medium and not just pure water. Hence, the presence of broth components and cell originating molecules can interfere with the extraction mechanisms of 3-HP.

Bioconversion media are known to contain microorganisms, salts, substrates, co-products and biomolecules as major impurities, in the case of optimized bioconversion conditions regarding pH and products yield^{12,13}. Regarding substrates, most recurrent ones are sugars like sucrose, lactose and glucose. These compounds have shown negligible effects on extraction performances for usual bioconversion concentrations in the case of propionic and lactic acid^{14,15}. Choudhury et al¹⁶ showed that glucose and nitrogen-containing compounds (from yeast extract) were only very poorly extracted in TOA, octanol and MIBK. For 3-HP production from glycerol, major co-products are 3-hydroxypropionaldehyde and 1,3-propanediol^{4,17}. It has been found that these 3 compounds had no effect on the extraction yields and were poorly or not extracted at all in the organic phase consisting in TOA and/or Aliquat 336 in decanol⁵. Accordingly, low molecular weight non-reactive molecules have rather low impacts on reactive extraction when present in common bioconversion concentrations.

The pH of the medium is probably the most studied parameter^{14,18-22}. The driving force for the complex formation being the acid-base interaction between the carboxyl group of the acid and the amine group of the extractant, pH is expected to have an important impact on extraction efficiency. It has been reported for many organic acids that if the pH of the solution is higher than the pK_A of the acid then the extraction yield is dramatically decreased when compared to acid solutions without pH

modification. For example, in the case of lactic acid ($pK_A = 3.86$) extraction by 30%v/v TOA in decanol, the extraction yield falls from more than 90% at initial pH between 2 and 3 to 0% at initial pH=6^{22,23}. For 3-HP, extraction yields also decrease with pH in the case of TOA with or without Aliquat 336 in decanol^{5,24}.

Besides this pH effect affecting extraction yield, some mass transfer limitations could occur because of microorganisms and biomolecules like proteins, acting as surface-active agents, that may significantly modify the liquid-liquid interface. It has been shown for example that the presence of microorganisms reduces the interfacial tension due to the presence of cells at the interface. For example, it has been observed that yeasts accumulate at decanol/water interface, inducing a physical blockage²⁵. Pursell et al²⁶ reported a 50% decrease of the mass transfer coefficient of chloramphenicol for biomass concentration of 0.1 g/L. However, even when cells are removed from bioconversion media, substantial effects remain that are thought to be due to biological surface-active agents as in the case of the reactive extraction of phenylalanine with Aliquat 336 from fermentation broth²⁷. In particular, proteins, even at low concentrations, are able to cover the interface by denaturation and unfolding of their chains²⁸. It was shown that the addition of 1 mg/L of albumin from bovine serum (BSA) decreased the interfacial tension and slowed down the extraction progress by reducing the mass transfer coefficient of chloramphenicol of 70% across the water/octanol interface²⁶.

Finally, a wide variety of salts could be found in the bioconversion broths. The effects of inorganic salts have been described as very impacting in reactive extraction of carboxylic acids with amines, inducing most of the time a dramatic reduction of the extraction yield. One could have expected a salting-out effect as for the classic liquid-liquid (non-reactive) extraction of an organic solute²⁹, but salt levels encountered in bioconversion media are not in the order of magnitude for the salting-out effect. Instead, in the case of reactive extraction, inorganic salts often induce a dramatic reduction of the extraction yield, for example for acetic^{30,31}, citric³² or lactic acids¹⁵. These studies reported the effects

of chlorides, phosphates, nitrates and sulfates from sodium, potassium or ammonium salts, decreasing the extraction yield.

Thus, the compounds found in complex biological media can strongly interfere in organic acids reactive extraction. Therefore, this paper aims to study the influence of selected bioconversion broth components on the efficiency of reactive liquid-liquid extraction of 3-hydroxypropionic acid with tri-*n*-octylamine in decanol (a good model system poorly soluble in water to study general mechanisms of extraction interferences) using a membrane contactor and in particular the influence of acid concentration, pH, some salts and proteins.

Experimental

Experimental strategy

Membrane-based reactive liquid-liquid extractions were performed by varying the amounts of aqueous phase species while the organic phase was maintained in its optimal formulation for 3-HP extraction with 20% v/v TOA in decanol⁸. Three initial 3-HP concentrations were tested in order to represent a depleted medium of extractive bioconversion where the concentration is not meant to be high: 0.5, 1 and 10 g/L. The initial pH was also varied within 3 values: pH=3.2 (natural pH), pH=4 and pH=5. To increase the initial pH, potassium hydroxide was added for an initial 3-HP concentration of 1 g/L. It aims at representing pH variation in a bioconversion process. Salts were also tested, potassium chloride (KCl) and potassium biphosphate (KH₂PO₄) were selected as model salts to study the influence of the ionic compounds and specifically the anion type. Three molar ratios of inorganic anion/3-HP were studied to understand the influence of the amount of salts: 1/10, 1/2 and 1/1. Potassium chloride being a neutral salt and considering its weak concentration, its addition into 3-HP solutions did not significantly change the pH. On the contrary, the biphosphate ion is an amphoteric species. To prevent pH deviations, 3-HP solutions containing potassium biphosphate were made with the targeted amounts of 3-HP and the corresponding amount of phosphoric acid and then neutralized with potassium hydroxide to the natural pH of the corresponding 3-HP concentration. The first and second

pK_A of phosphoric acid being 2.15 and 7.2, biphosphate ion is almost the only form of phosphoric acid present in solution. Other forms (non-dissociated phosphoric acid, hydrogenophosphate and phosphate ions) are thus neglected.

In order to mimic biomolecules release, the protein albumin from bovine serum (BSA) was used as a model biosurfactant. Its concentration was set to correspond to the estimated proteins concentration that we found in previous 3-HP bioconversion broths, i.e. around 8 mg/L. Each experiment was repeated twice.

Chemicals

Organic phases were made of 20% v/v tri-*n*-octylamine (TOA, 98% purity, Sigma-Aldrich, USA) diluted in decanol (99% purity, Sigma-Aldrich, USA). Aqueous phases consisted in 3-HP (28.1% wt in water, TCI Europe, Belgium) diluted in ultrapure water with on purpose additions of potassium chloride (KCl, >97%, VWR, USA), phosphoric acid (H₃PO₄, 85% wt in water, Thermo Fisher Scientific, USA), potassium hydroxide and BSA (≥ 98%, Sigma-Aldrich, USA). *n*-Octylamine (99% purity) and di-*n*-octylamine (97% purity) were freely provided by Sigma-Aldrich for TOA impurities analyses.

Membrane-assisted reactive extraction

Liquid-liquid extractions were performed using a hollow fiber membrane contactor (HFMC), the 2.5x8 X50 Liqui-Cel® module with hydrophobic polypropylene fibers (Membrana, USA). The properties of the membrane contactor are given in table 1.

Table 1. Characteristics of Liqui-Cel commercial module used.

Module 2.5x8		Fibers X50	
Material	Polypropylene	Material	polypropylene
Internal diameter	58.4 mm	Internal diameter	220 μm
Internal length	20.3 mm	External diameter	300 μm
Number of fibers	~ 9800	Effective length	146 mm
Internal surface area of the fibers	~1 m ²	Wall thickness	40 μm
		Porosity	40%
		Average pore diameter	0.03 μm

The aqueous phase was pumped through the lumen side of the fibers at a flowrate of 8.6 mL/s and the organic phase through the shell side of the module at a flowrate of 8.1 mL/s in counter-current cross-flow configuration using volumetric pumps (Magnet Gear Pump, model MDG-H2T, Iwaki, Japan), meaning that the liquid-liquid interface is located at the internal diameter of the fibers. Flowrates were sufficiently high to prevent the influence of the hydrodynamics on the mass transfer rates. Both phases were maintained in closed loop configurations as in Figure 1 with a transmembrane pressure of 0.4 bar between the outlet of the aqueous phase and the inlet of the organic phase. Each phase had a global volume of 500 mL which was constant and was stirred with a magnetic stirrer and maintained at $25 \pm 1^\circ\text{C}$ with heated water baths. The residence times of the aqueous and organic phases in the membrane module were around 6 and 36 s respectively. Samples of the aqueous phase were taken at regular times for further analyses. The hydrodynamic conditions were kept constant all along the study to attribute extraction variations only to the change of composition of the aqueous phase which is the purpose of the study.

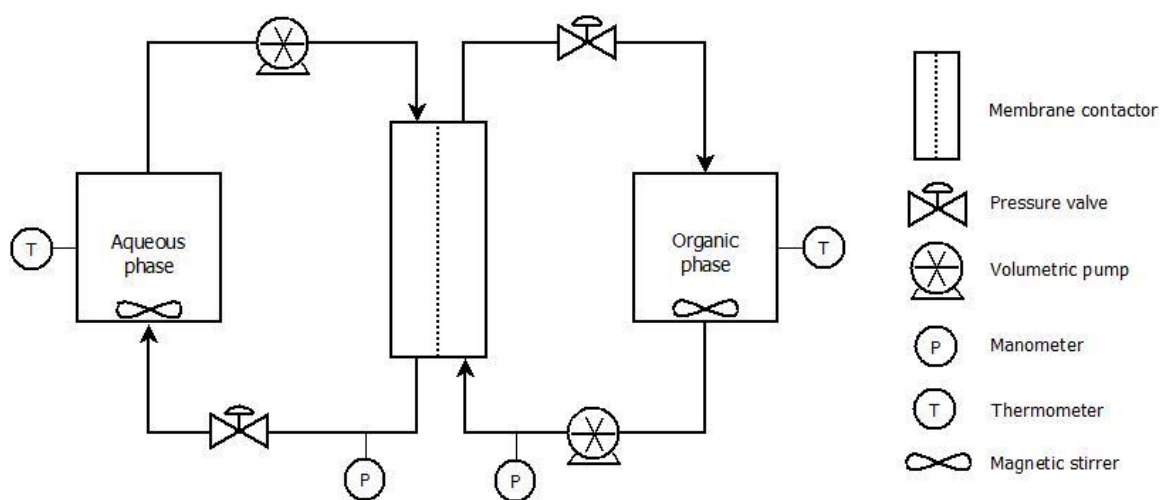

Figure 1. Process flow diagram of the membrane-assisted reactive extraction experimental set-up.

Calculated parameters

The extraction yield (Y) represents the proportion of acid removed from the aqueous phase. As the phase volumes are observed to be constant during experiments, the extraction yield was calculated as follows:

$$Y = \frac{[AH]_{ini} - [AH]_{eq}}{[AH]_{ini}}$$

The influence of the media components on the kinetics was evaluated using the $t_{63\%}$, the time needed to extract 63% of the total extracted acid. This parameter was determined graphically, referring at the curves shape, showing an empirical first order decrease. In that case, $t_{63\%}$ would correspond to a time constant. It was chosen as a neutral parameter given that, a global mass transfer coefficient is not the most appropriate parameter given the chemical transformations of the species and the reagents consumption over time.

In order to present directly comparable results without scale problems, the dimensionless concentrations are commonly used in the figures. It is simply the concentration at time t divided by the initial concentration.

Analytical methods

The concentration of biphosphate and chloride ions in the aqueous phase was determined using High-Performance Anion Exchange Chromatography (HPAEC) coupled with Conductimetric Detection (ICS-2000, Dionex, USA) with an IonPac AS14 anion exchange column (4x250 mm, Thermo Fischer Scientific, USA) and an IonPac AG50 guard column (4x50 mm, Thermo Fischer Scientific, USA) followed by an anion suppressor ASRS 300 (Dionex, USA) for suppressed conductivity detection. The mobile phase was a sodium carbonate (3.5 mM)-bicarbonate (1 mM) buffer flowing at 1.2 mL/min, a routine method recommended by the column supplier.

3-HP was analyzed using high performance liquid chromatography (HPLC) and *n*-octylamine and di-*n*-octylamine present in aqueous phases with ultra-high performance liquid chromatography coupled with high resolution mass spectroscopy (HPLC-HRMS). Both analytical methods were detailed in a previous publication⁸. When proteins were present in the samples, 140 μ L of 90 %wt trichloroacetic acid was added to 860 μ L of the sample and the new samples were left an hour at 4 °C. These samples were then centrifuged and passed through 0.2 μ m filters before HPLC analyses.

pH values were measured with a Jenco vision 6071 pH meter.

The statistical significance of difference between data was assessed using ANOVA tests with a significance level set to 0.05. For comparison, p-values (p) are given in the results when necessary. For correlation between two measured parameters, the coefficient of determination (R^2) is provided.

Results and discussion

Influence of initial acid concentration

In a first set of experiments, the extraction kinetics in membrane contactor were studied as a function of initial 3-HP concentration. Results are shown in Figure 2 and the deduced parameters, yield and time constant, in Table 1.

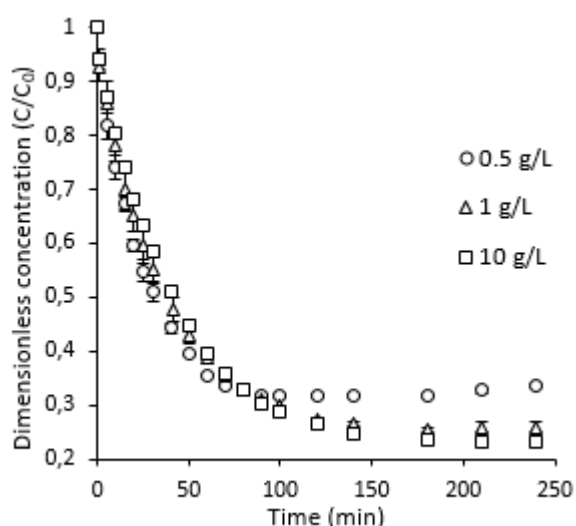

Figure 2. Dimensionless concentration of 3-HP in the aqueous phase over time for different initial acid concentrations.

First, we observe significant differences ($p < 0.05$ for both yield and $t_{63\%}$) among the three final yields and kinetics. Indeed, for the 3-HP concentration levels studied, the higher the initial concentration, the higher the extraction yield (66 – 77%, from 0.5 to 10 g/L) and the slower the kinetics ($t_{63\%}$ between 22 and 40 min from 0.5 to 10 g/L) (Table 1). Such yield variations were shown to be due to organic impurities⁸ released in the aqueous phase, in particular primary and secondary amines residues initially present in TOA, and not to a limitation in terms of the complexation reaction of extraction. Indeed,

according to reaction 1, a lower initial 3-HP concentration for the same amine concentration means a higher excess of amine and accordingly leads to a higher complexation yield. Concerning the kinetics, it was also shown to be slowed down when increasing 3-HP concentration from 0.5 to 2 g/L using a similar membrane contactor with a different extractant phase made of TOA and Aliquat 336 in *n*-decanol²⁴.

Table 2. Summary of yield and kinetics parameters for all experimental conditions.

[3-HP] (g/L)	Cl ⁻ /3-HP (mol ratio)	H ₂ PO ₄ ⁻ /3-HP (mol ratio)	BSA (mg/L)	Initial pH	Yield (%)	t _{63%} (min)
0.5	0	0	0	3.4	66 ± 1	22 ± 2
1	0	0	0	3.2	74 ± 1	33 ± 4
10	0	0	0	2.7	77 ± 1	40 ± 1
1	0	0	0	4	43 ± 1	21 ± 2
1	0	0	0	5	5 ± 2	8 ± 5
1	1	0	0	3.2	18 ± 1	16 ± 4
1	1/2	0	0	3.2	32 ± 1	24 ± 1
1	1/10	0	0	3.2	55 ± 1	25 ± 1
1	0	1	0	3.2	38 ± 1	20 ± 1
1	0	1/2	0	3.2	46 ± 1	20 ± 1
1	0	1/10	0	3.2	54 ± 1	22 ± 1
1	0	0	8	3.3	73 ± 1	28 ± 1

Influence of initial pH

Extraction kinetics with 3 different initial pH (3.2, 4 and 5) with the same initial acid concentration (1 g/L) are disclosed in Figure 3.

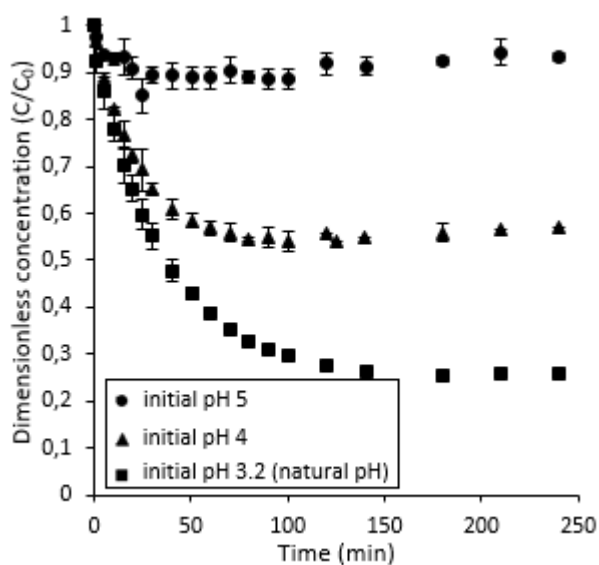

Figure 3. Dimensionless concentration of 3-HP in the aqueous phase over time for different initial pH (initial 3-HP concentration: 1 g/L).

At pH = 5, the extraction yield is very weak around 8%, while, at pH = 4 and natural pH, 43% and 74% are obtained respectively (Table 1). As the amine is only able to extract the protonated form of the acid, it is consistent with the gradual diminution of initial fraction of non-dissociated acid with initial pH. Indeed, as the pK_A of 3-HP is 4.51, pH 5, 4 and 3.2 correspond to 24%, 76% and 97% of non-dissociated fractions of 3-HP in solution respectively (see Figure 4) and hence the extraction yield of 3-HP (based on the total 3-HP concentration as dissociated and non-dissociated) decreases accordingly with the dissociated part remaining in the aqueous phase.

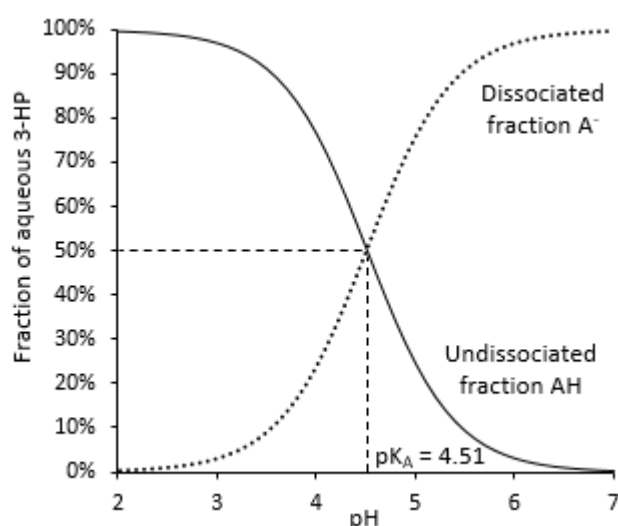

Figure 4. Proportions of 3-HP aqueous speciations as a function of pH in a dilute solution.

As a matter of fact, the equilibrium pH reached 6.6 for a solution with an initial pH 5. This behavior is similar to what has been found for other carboxylic acids^{18,19,23}. Concerning the kinetics, it can be noticed that the higher the pH, the faster the extraction ($t_{63\%} = 8$ min at pH 5 and 33 min at pH 3.2). The effects are comparable to the concentration effects shown in Figure 2. Thus, the pH effects are mainly due to the variation of concentration of the undissociated fraction of 3-HP. For the implementation of an extractive bioconversion, it would be necessary to use pH-tolerant microorganisms such as yeasts^{12,33,34} or acetic acid bacteria, for example from acetobacter³⁵ or gluconobacter³⁶ genera with a pH regulation mainly undertaken by the acid removal.

Influence of the presence of salts

Figures 4 and 5 provide the extraction kinetics of 1 g/L 3-HP initially in the presence of potassium chloride and potassium biphosphate in different proportions.

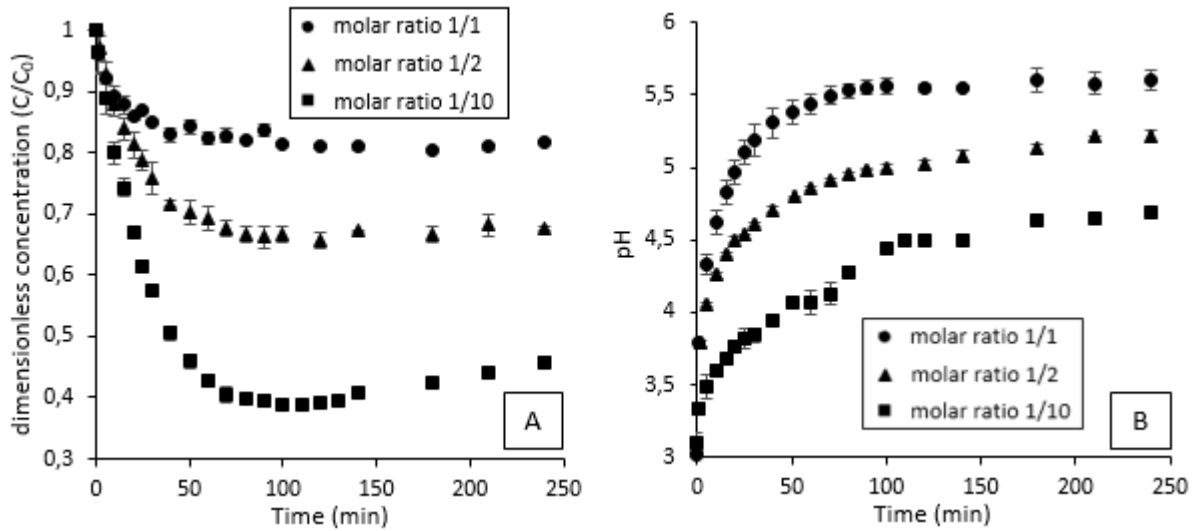

Figure 5. Dimensionless concentration of 3-HP (A) and pH evolution in the aqueous phase (B) over time for different initial $\text{Cl}^-/3\text{-HP}$ molar ratios (initial concentration of 3-HP= 1 g/L).

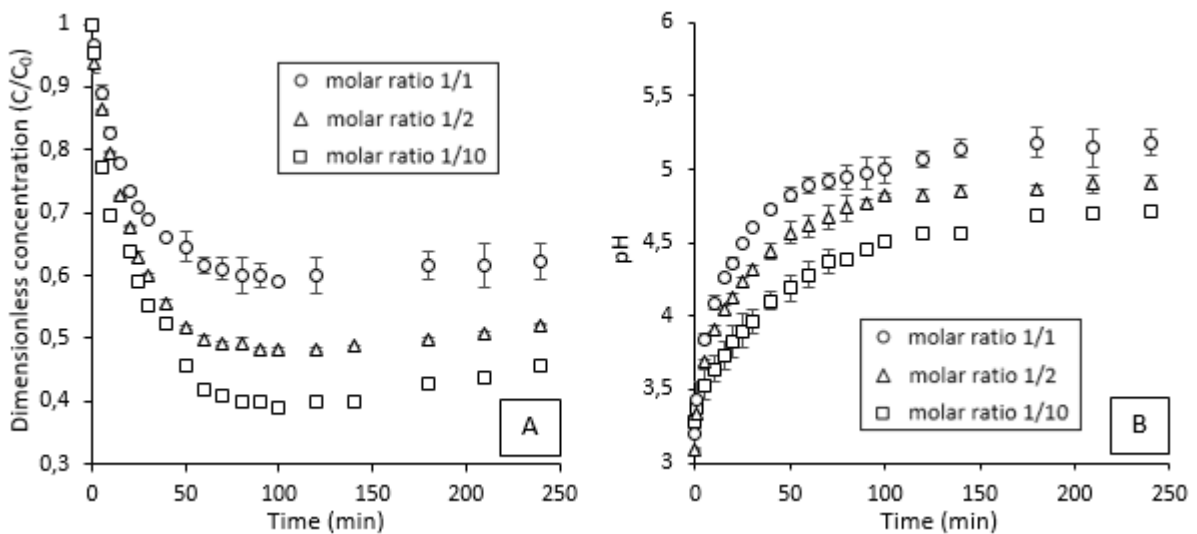

Figure 6. Dimensionless concentration of 3-HP (A) and pH evolution in the aqueous phase (B) over time for different initial $\text{H}_2\text{PO}_4^-/3\text{-HP}$ molar ratios (initial concentration of 3-HP = 1 g/L).

Both biphosphate and chloride salts hindered the extraction of 3-HP. The higher the salt concentration, the lesser the extraction yield. Potassium biphosphate appears to have less impact on 3-HP extraction than potassium chloride. For example, for a 1/1 ratio at $t=100$ min, 81% of initial 3-HP remain in the aqueous phase with the chloride ions whereas only 59% remain for the biphosphate ions. For both salts, after 100 minutes of extraction, the concentration of 3-HP tends to increase in the aqueous

phase. This is due to interactions with TOA impurities (water soluble protonated *n*-octylamine and di-*n*-octylamine) and will be discussed in detail further.

The more salt in solution, the higher the final pH of the solution ($p < 0.01$) of otherwise similar initial pH before the beginning of the reactive extraction. The impact of chloride ions seems again greater than the biphosphate ions on pH. Final pH of 5.6 or 4.9, for example, corresponding to experimental 3-HP concentrations of 8 and 7 mM respectively were found (figures 4 and 5). Such high pH indicate the production of the conjugate base of 3-HP without the presence of any basic species in the aqueous phase initially.

To understand these variations in extraction yield and pH and clarify how the salts interfere with the extraction, the concentrations of the different species present in the aqueous phase were determined (Figure 6).

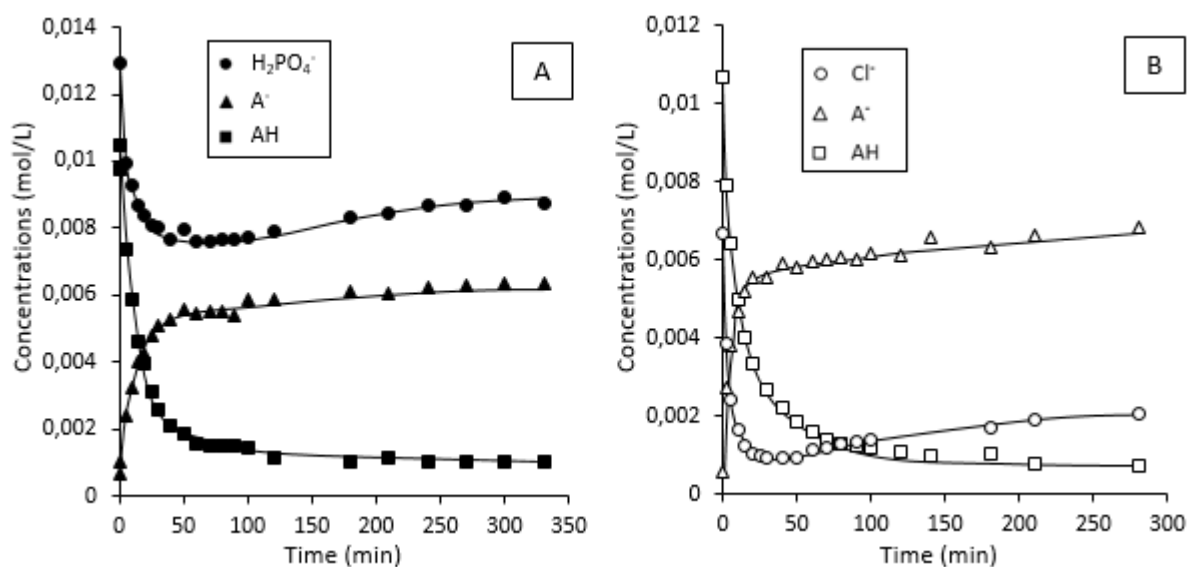

Figure 7. Concentrations as a function of time in the case of the presence of potassium biphosphate (A) and potassium chloride (B) with initial KCl/3-HP and KH₂PO₄/3-HP molar ratios of 1/1 and 1/2 respectively (initial 3-HP concentration = 1 g/L).

Concentrations of dissociated (A⁻) and non-dissociated (AH) forms of 3-HP were calculated from pH measurements according to:

$$[A^-] = \frac{10^{pH-pK_A}}{1 + 10^{pH-pK_A}} [AH]_{HPLC}$$

$$[AH] = \frac{1}{1 + 10^{pH-pK_A}} [AH]_{HPLC}$$

where $[AH]_{HPLC}$ is the total concentration (dissociated and non-dissociated) of 3-HP as determined by HPLC.

Figure 6 shows that the concentration of inorganic anions is decreasing rapidly over time indicating they are transferred to the organic phase. This phenomenon is not observed when there is no 3-HP in the aqueous phase since the inorganic salts are not extracted when they are alone (data not shown). Along with the fast decrease of the inorganic anions, we can observe a high increase of the dissociated 3-HP, a carboxylate anion, at the opposite rate.

These observations argue in favor of an anion exchange as described in reactions 2 and 3, a mechanism that induces a decrease in the extraction yield when 3-HP is extracted in the presence of salts (for example a 4-time decrease for a molar ratio of 1/1 between 3-HP and KCl, see Table 1):



Indeed, the release of the carboxylate conjugate of 3-HP in the aqueous phase increases the pH of the solution. The more salt in solution, the more carboxylate released and then the higher the pH and the lesser the extraction yield. From the present results, we can see that chloride ions are more readily extracted (faster with a higher yield) than the biphosphate ions which demonstrates a higher affinity of Cl^- for the ammonium cation. The smaller size of chloride, its non-delocalized charge and the stronger acidity of hydrochloric acid when compared to phosphoric acid could be the explanation in a protic solvent.

Concerning industrial broths, it is expected that there are much less salts than 3-HP produced, around 1 %mol for example according to Cargill patent¹². Hence, the extraction process should not be much

impacted but a subsequent polishing step to remove the inorganic anions from the recovered 3-HP will be needed.

Similar results were also reported in the literature. In a recent work³⁷, Matsumoto et al also reported a large antagonism for 3-HP extraction upon the addition of NaCl in high concentrations (>1 mol/L) with an extracting system made of TOA in *n*-octanol. When there is no acid in the aqueous phase, the extraction of the salt is negligible. But when there is an organic acid in the solution, the anion concentration decreases while the cation concentration remains unchanged³⁰. It seems that while the cation of the salt does not take part in any chemical reaction, the anion is extracted in the organic phase through the formation of an anion pair with ammonium very similarly to the extraction of the corresponding inorganic acid. As a result, the aqueous phase is loaded with carboxylates of the organic acid, and an increase in pH can be observed. This effect is such that a saline aqueous solution can be used as a back-extraction phase to recover the organic acid from a loaded organic phase, with back-extraction efficiency varying according to the anion of the salt³⁸. To sum up, the presence of salts induces a drastic decrease in the extraction yield with the increase of salt concentrations by an anion exchange mechanism releasing the carboxylate conjugate of the acid in the aqueous phase. Limiting salts accumulation in the broth is then necessary to master the process efficiency and a further polishing step could be needed for the complete purification of the acid.

Influence of organic impurities

As mentioned before on Figures 4 and 5, one could notice a significant increase of the 3-HP concentration for the lowest salt/acid ratio tested (1/10) after 100 min of extraction. This increase is only due to the carboxylate form of 3-HP. It is not related to an anion exchange mechanism or to non-dissociated 3-HP since non-dissociated 3-HP and inorganic anions concentrations remain rather constant over time after $t=100$ min (figure 7). The only possibility left is that the carboxylate anions come from the organic phase of extraction where the carboxylate is part of the $(TOAH^+, A^-)$ complex (reaction 1). If so, a cation must be equally released in the aqueous phase and the only existing cations

in the organic phase are ammoniums. Tri-*n*-octylammonium is very poorly soluble in water and we think that this phenomena is mainly due to impurities consisting in *n*-octylamine (OA) and di-*n*-octylamine (DOA) as already reported in a previous work⁸. The concentrations of smaller amines (i.e. OA and DOA) has been measured over time during the extraction and are plotted in figure 7 as well as the concentrations of the other compounds. It is obvious that after t = 50 min 3-hydroxypropionate anions and amines (ammoniums) in the aqueous phase are strongly correlated ($R^2=0.99$). Thus, we show that 3-HP is first extracted in the organic phase probably forming a TOA complex which then might rearrange to form the *n*-octylammonium salt with the residual *n*-octylamine and the salt is then released in the aqueous phase.

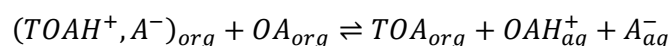

This would explain the delayed increase observed for 3-HP concentration compared to its extraction.

This phenomenon also occurs with the anion of the salts as it can be seen in figure 6.

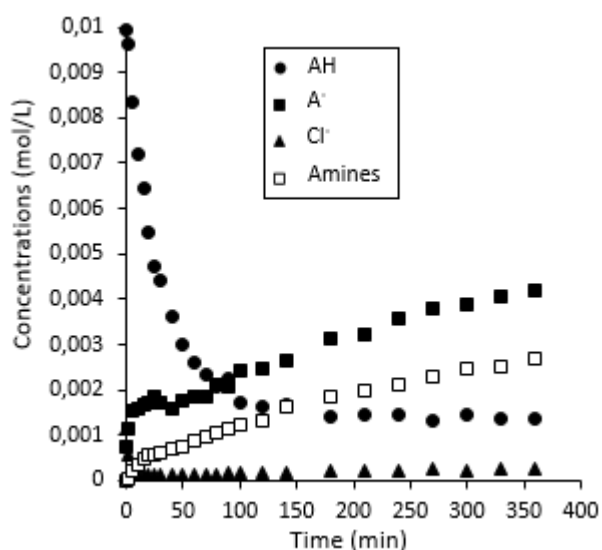

Figure 8. Concentrations in aqueous phase as a function of time in the presence of potassium chloride with a molar ratio 3-HP/KCl of 1/10 (amines = *n*-octylamine + di-*n*-octylamine).

Therefore, it is to be noticed that the presence water soluble amines in the organic phase should be carefully avoided as they will always transfer to the aqueous phase in the presence of acid, lower the extraction yield and possibly inhibit bioconversions. Several methods have been described to remove such impurities from the initial organic phase such as acidic washings⁸ or adsorption processes³⁹.

Influence of proteins

Unlike salts, the influence of non-reacting biomolecules should be different as they are not meant to interact chemically with the complex. However, an influence on the kinetics could be expected. Concerning the influence of proteins, we tested a protein concentration of 8 mg/L representing what has been found in some bioconversion broth while avoiding pH buffering effects. The results are depicted in figure 8.

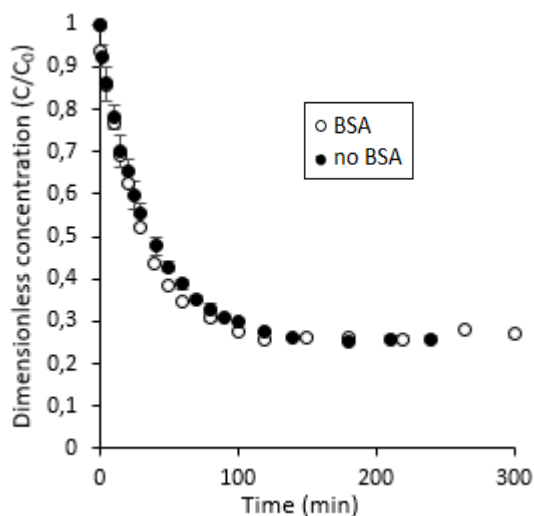

Figure 9. Dimensionless 3-HP concentration in the aqueous phase over time in the presence (8mg/L) and absence of BSA.

No significant difference in yields or kinetics can be observed between the presence and the absence of proteins. Indeed, BSA is not supposed to interact strongly with 3-HP or the complex formed with TOA and, accordingly, the yield remains unchanged ($p > 0.5$) at 74% (Table 1). The extraction kinetics are also not significantly different ($p > 0.3$), the parameter $t_{63\%}$ being 28 ± 1 and 33 ± 4 min with and without BSA respectively. Several reasons can be suggested for this. The size of a BSA molecule (modeled as a prolate ellipsoid with a major axis of 14 nm and a minor axis of 4 nm at 25 °C in water⁴⁰) is in the same order of magnitude than the pore size of the membrane (average diameter of 30 nm). However, the most probable explanation is that the supplementary interfacial resistance due to proteins adsorption, creating sort of a thin permeable wall, may be negligible in comparison with the high membrane resistance whose 100 μm -longed pores are filled with a stagnant viscous organic phase. Most of the transfer hindrance is due to the membrane itself and not to the physical

interactions between aqueous species. Then, we expect other proteins to have the same negligible effect. Another property such as the isoelectric point of real broth proteins should not be discriminating as the broth pH<4 lies under the isoelectric point of most of them. On top of that, the decrease of interfacial tension due to the presence of surface-active compounds can lead to emulsion problems in dispersive extractions. Membrane-assisted extraction being a non-dispersive process, lowering interfacial tension is a bit less problematical. Therefore, the presence of proteins seems to have no impact on the membrane-assisted extraction in the short term for such concentrations.

Conclusion

The influence of the bioconversion broths components (produced acid concentration, pH, salts, proteins) on membrane-based reactive extraction of organic acids is here reported for the case of 3-hydroxypropionic acid using tri-*n*-octylamine in *n*-decanol. It was shown that the reduction of acid concentration favored the kinetics of the extraction, due to a higher complexation extent inducing a higher driving force for the mass transfer. Moreover, increasing the pH from 3 to 5 was shown to strongly decrease the performances of the extraction process. Furthermore, it was found that salts had a major impact, decreasing the extraction yield with the increase of salt concentrations by an anion exchange mechanism releasing the carboxylate conjugate of the acid in the aqueous phase. Conversely, no influence of proteins on the kinetics, because of the preponderant membrane resistance, nor on the yield of extraction was detected. Based on these results, the composition of bioconversion media is strongly impacting the 3-HP recovery efficiency. To reduce such interferences, low-pH-tolerant micro-organisms, low levels of salts, pure extractants and organic phase formulation are recommended. Some interactions mechanisms have been highlighted and valuable data for future implementations have also been provided.

Acknowledgement

The authors are grateful to Région Grand Est, and the Conseil Départemental de la Marne and Grand Reims for financial support.

References

1. Werpy, T. et al. Top Value Added Chemicals from Biomass, Volume 1—Results of Screening for Potential Candidates from Sugars and Synthesis Gas. (U.S. Department of Energy, 2004).
2. Kumar, V., Ashok, S. & Park, S. Recent advances in biological production of 3-hydroxypropionic acid. *Biotechnology Advances* **31**, 945–961 (2013).
3. Burgé, G. et al. Towards an extractive bioconversion of 3-hydroxypropionic acid: study of inhibition phenomena: Evaluation of bacterial cell inhibition during 3-HP extractive bioconversion. *Journal of Chemical Technology & Biotechnology* **92**, 2425–2432 (2017).
4. Dishisha, T., Pereyra, L. P., Pyo, S.-H., Britton, R. A. & Hatti-Kaul, R. Flux analysis of the *Lactobacillus reuteri* propanediol-utilization pathway for production of 3-hydroxypropionaldehyde, 3-hydroxypropionic acid and 1,3-propanediol from glycerol. *Microbial Cell Factories* **13**, 76 (2014).
5. Moussa, M. et al. Reactive extraction of 3-hydroxypropionic acid from model aqueous solutions and real bioconversion media. Comparison with its isomer 2-hydroxypropionic (lactic) acid. *Journal of Chemical Technology & Biotechnology* **91**, 2276–2285 (2015).
6. Pal, D., Tripathi, A., Shukla, A., Gupta, K. R. & Keshav, A. Reactive Extraction of Pyruvic Acid Using Tri-n-octylamine Diluted in Decanol/Kerosene: Equilibrium and Effect of Temperature. *Journal of Chemical & Engineering Data* **60**, 860–869 (2015).
7. Wasewar, K. L., Heesink, A. B. M., Versteeg, G. F. & Pangarkar, V. G. Equilibria and kinetics for reactive extraction of lactic acid using Alamine 336 in decanol. *Journal of Chemical Technology & Biotechnology* **77**, 1068–1075 (2002).
8. Chemarin, F. et al. New insights in reactive extraction mechanisms of organic acids: An experimental approach for 3-hydroxypropionic acid extraction with tri-n-octylamine. *Separation and Purification Technology* **179**, 523–532 (2017).

9. Nelson, R., Peterson, D., Karp, E., Beckham, G. & Salvachúa, D. Mixed Carboxylic Acid Production by *Megasphaera elsdenii* from Glucose and Lignocellulosic Hydrolysate. *Fermentation* **3**, 10 (2017).
10. Wu, Z. & Yang, S. T. Extractive fermentation for butyric acid production from glucose by *Clostridium tyrobutyricum*. *Biotechnology and Bioengineering* **82**, 93–102 (2003).
11. Chemarin, F., Moussa, M., Allais, F., Athès, V. & Trelea, I. C. Mechanistic modeling and equilibrium prediction of the reactive extraction of organic acids with amines: A comparative study of two complexation-solvation models using 3-hydroxypropionic acid. *Separation and Purification Technology* **189**, 475–487 (2017).
12. Abraham, T. W. et al. Recovery of 3-hydroxypropionic acid. US Patent 2016/0060204 A1 (2014).
13. Schulze, J., Tietz, W., Waengler, I. & Kuehlein, K. Method for purifying carboxylic acids from fermentation broth. US Patent 2014/0371486 A1 (2014).
14. Keshav, A., Wasewar, K. L. & Chand, S. Extraction of propionic acid from model solutions: Effect of pH, salts, substrate, and temperature. *AIChE Journal* **55**, 1705–1711 (2009).
15. San-Martín, M., Pazos, C. & Coca, J. Reactive extraction of lactic acid with alamine 336 in the presence of salts and lactose. *Journal of Chemical Technology and Biotechnology* **54**, 1–6 (1992).
16. Choudhury, B., Basha, A. & Swaminathan, T. Study of lactic acid extraction with higher molecular weight aliphatic amines. *Journal of Chemical Technology & Biotechnology* **72**, 111–116 (1998).
17. Burgé, G. et al. Diversity of *Lactobacillus reuteri* Strains in Converting Glycerol into 3-Hydroxypropionic Acid. *Applied Biochemistry and Biotechnology* **177**, 923–939 (2015).
18. Hossain, M. M. & Maisuria, J. L. Effects of Organic Phase, Fermentation Media, and Operating Conditions on Lactic Acid Extraction. *Biotechnology Progress* **24**, 757–765 (2008).
19. Gorden, J., Zeiner, T. & Brandenbusch, C. Reactive extraction of cis,cis-muconic acid. *Fluid Phase Equilibria* **393**, 78–84 (2015).
20. Canari, R. & Eyal, A. M. Effect of pH on Dicarboxylic Acids Extraction by Amine-Based Extractants. *Industrial & Engineering Chemistry Research* **42**, 1293–1300 (2003).

21. Galaction, A.-I., Blaga, A.-C. & Cascaval, D. The influence of pH and solvent polarity on the mechanism and efficiency of folic acid extraction with amberlite LA-2. *Chemical Industry and Chemical Engineering Quarterly* **11**, 63–68 (2005).
22. Yankov, D., Molinier, J., Albet, J., Malmay, G. & Kyuchoukov, G. Lactic acid extraction from aqueous solutions with tri-n-octylamine dissolved in decanol and dodecane. *Biochemical Engineering Journal* **21**, 63–71 (2004).
23. Kyuchoukov, G., Marinova, M., Molinier, J., Albet, J. & Malmay, G. Extraction of Lactic Acid by Means of a Mixed Extractant. *Industrial & Engineering Chemistry Research* **40**, 5635–5639 (2001).
24. Burgé, G. et al. Reactive extraction of bio-based 3-hydroxypropionic acid assisted by hollow-fiber membrane contactor using TOA and Aliquat 336 in n-decanol. *Journal of Chemical Technology & Biotechnology* **91**, 2705–2712 (2016).
25. Weatherley, L. R. Some Fundamental Innovations in Direct Solvent Extraction of Low Molecular Weight Biological Products. *Mineral Processing and Extractive Metallurgy Review* **18**, 147–174 (1998).
26. Pursell, M. R., Mendes-Tatsis, M. A. & Stuckey, D. C. Effect of fermentation broth and biosurfactants on mass transfer during liquid-liquid extraction. *Biotechnology and Bioengineering* **85**, 155–165 (2004).
27. Pursell, M. R., Mendes-Tatsis, M. A. & Stuckey, D. C. Co-Extraction during Reactive Extraction of Phenylalanine using Aliquat 336: Interfacial Mass Transfer. *Biotechnology Progress* **19**, 469–476 (2003).
28. Fainerman, V. B., Lucassen-Reynders, E. H. & Miller, R. Adsorption of surfactants and proteins at fluid interfaces. *Colloids and Surfaces A: Physicochemical and Engineering Aspects* **143**, 141–165 (1998).
29. Kislik, V. S. Solvent extraction: classical and novel approaches. (Elsevier, 2012).

30. Reyhanitash, E., Zaalberg, B., Kersten, S. R. A. & Schuur, B. Extraction of volatile fatty acids from fermented wastewater. *Separation and Purification Technology* **161**, 61–68 (2016).
31. Schunk, A. & Maurer, G. On the influence of some strong electrolytes on the partitioning of acetic acid to aqueous/organic two-phase systems in the presence of tri-n-octylamine. *Fluid Phase Equilibria* **267**, 23–38 (2008).
32. Schunk, A. & Maurer, G. On the Influence of Some Inorganic Salts on the Partitioning of Citric Acid between Water and Organic Solutions of Tri- n -octylamine. Part II: Toluene as Organic Solvent. *Industrial & Engineering Chemistry Research* **44**, 8837–8851 (2005).
33. Kildegaard, K. R. et al. Engineering and systems-level analysis of *Saccharomyces cerevisiae* for production of 3-hydroxypropionic acid via malonyl-CoA reductase-dependent pathway. *Microbial Cell Factories* **15**, (2016).
34. Gao, M.-T., Shimamura, T., Ishida, N. & Takahashi, H. Application of metabolically engineered *Saccharomyces cerevisiae* to extractive lactic acid fermentation. *Biochemical Engineering Journal* **44**, 251–255 (2009).
35. Li, J. et al. Immobilization of *Acetobacter* sp. CGMCC 8142 for efficient biocatalysis of 1,3-propanediol to 3-hydroxypropionic acid. *Biotechnology and Bioprocess Engineering* **21**, 523–530 (2016).
36. Zhao, L., Lin, J., Wang, H., Xie, J. & Wei, D. Development of a two-step process for production of 3-hydroxypropionic acid from glycerol using *Klebsiella pneumoniae* and *Gluconobacter oxydans*. *Bioprocess and Biosystems Engineering* **38**, 2487–2495 (2015).
37. Matsumoto, M., Shibasaki, M. & Kondo, K. Salting-out Extraction of 3-Hydroxypropionic Acid with Reactive Extraction and Aqueous Two-phase Systems. *Solvent Extraction Research and Development* **24**, 141–147 (2017).
38. Puttemans, M., Dryon, L. & Massart, D. L. Extraction of organic acids by ion-pair formation with tri-n-octylamine: Part 2. Back-extraction. *Analytica Chimica Acta* **161**, 381–386 (1984).

39. Coenen, A., Kosswig, K., Von Praun, F. & Schüller, H.-P. Purification of tertiary amines using an adsorbent. US Patent 4,255,356 (1981).
40. Kent Wright, A. & Thompson, M. R. Hydrodynamic structure of bovine serum albumin determined by transient electric birefringence. *Biophysical Journal* **15**, 137–141 (1975).