



**HAL**  
open science

## **Two industrial examples of coupling experiments and simulations for increasing quality and yield of distilled beverages**

Martine Esteban-Decloux, Sophie Deterre, Samir Kadir, Pierre Giampaoli, Joël Albet, Xavier Joulia, Olivier Baudouin

### **► To cite this version:**

Martine Esteban-Decloux, Sophie Deterre, Samir Kadir, Pierre Giampaoli, Joël Albet, et al.. Two industrial examples of coupling experiments and simulations for increasing quality and yield of distilled beverages. Food and Bioproducts Processing, 2014, 92 (4), pp.343-354. <10.1016/j.fbp.2013.10.001>. <hal-01951993>

**HAL Id: hal-01951993**

**<https://agroparistech.hal.science/hal-01951993v1>**

Submitted on 11 Dec 2018

**HAL** is a multi-disciplinary open access archive for the deposit and dissemination of scientific research documents, whether they are published or not. The documents may come from teaching and research institutions in France or abroad, or from public or private research centers.

L'archive ouverte pluridisciplinaire **HAL**, est destinée au dépôt et à la diffusion de documents scientifiques de niveau recherche, publiés ou non, émanant des établissements d'enseignement et de recherche français ou étrangers, des laboratoires publics ou privés.



HAL Authorization

## Accepted Manuscript

Title: Two industrial examples of coupling experiments and simulations for increasing quality and yield of distilled beverages

Author: Esteban-Decloux Martine Deterre Sophie Kadir Samir Giampaoli Pierre Albet Joël Joulia Xavier Baudouin Olivier

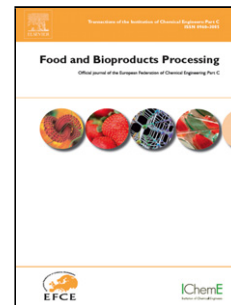

PII: S0960-3085(13)00098-9  
DOI: <http://dx.doi.org/doi:10.1016/j.fbp.2013.10.001>  
Reference: FBP 446

To appear in: *Food and Bioprocess Processing*

Received date: 27-12-2012  
Revised date: 29-9-2013  
Accepted date: 3-10-2013

Please cite this article as: Martine, E.-D., Sophie, D., Samir, K., Pierre, G., Joël, A., Xavier, J., Olivier, B., Two industrial examples of coupling experiments and simulations for increasing quality and yield of distilled beverages, *Food and Bioprocess Processing* (2013), <http://dx.doi.org/10.1016/j.fbp.2013.10.001>

This is a PDF file of an unedited manuscript that has been accepted for publication. As a service to our customers we are providing this early version of the manuscript. The manuscript will undergo copyediting, typesetting, and review of the resulting proof before it is published in its final form. Please note that during the production process errors may be discovered which could affect the content, and all legal disclaimers that apply to the journal pertain.

**Title**

Two industrial examples of coupling experiments and simulations for increasing quality and yield of distilled beverages.

**Authors names**

Esteban-Decloux Martine<sup>1\*</sup>, Deterre Sophie<sup>1</sup>, Kadir Samir<sup>1</sup>, Giampaoli Pierre<sup>1</sup>, Albet Joël<sup>2,3</sup>, Joulia Xavier<sup>4,5</sup>, Baudouin Olivier<sup>6</sup>

**Affiliations**

<sup>1</sup>AgroParisTech, UMR 1145 GENIAL, F-91300 Massy, France.

<sup>1</sup>INRA, UMR 1145 GENIAL, F-91300 Massy, France.

<sup>1</sup>Cnam, UMR 1145 GENIAL, F-91300 Massy, France.

<sup>2</sup>INRA, UMR 1010, F-31030, Toulouse cedex 4, France.

<sup>3</sup>Université de Toulouse, INPT-ENSIACET, Laboratoire de Chimie Agro-industrielle, F-31030 Toulouse, France.

<sup>4</sup>Université de Toulouse INPT-UPS, Laboratoire de Génie Chimique; F-31030 Toulouse cedex 4, France.

<sup>5</sup>CNRS ; Laboratoire de Génie Chimique ; F-31062 Toulouse, France.

<sup>6</sup>ProSim SA, Immeuble Stratège A, 51, rue Ampère, F-31670 Labège, France.

\*Corresponding author. Tel.: +33 1 69 93 50 92 fax: +33 1 69 93 50 44

E-mail address: [martine.esteban-decloux@agroparistech.fr](mailto:martine.esteban-decloux@agroparistech.fr) (M. Esteban-Decloux).

**Abstract**

The aim of this study was to check the ability of ProSim® software to model both continuous and batch distillations of two specific industrial units in order to obtain a both a better understanding of the behaviour of aroma volatile components and a tool to optimise the still's operation. Simulations of multistage continuous distillation to produce neutral spirit from raw alcohol and of batch distillation to produce bitter orange distillate from bitter orange peels macerate were carried out with ProSimPlus and BatchColumn software. Simulations were compared with distillations performed in two industrial plants. For each case, the industrial plants were studied to determine all the operating parameters and the behaviour of certain compounds selected for their high concentration or quality impact. Then, the NRTL and Henry's law

thermodynamic models were chosen. Simulation results of particular compositions of the selected compounds in the different extractions were analysed and compared with experimental measurements. Simulations represented faithfully the behaviour of compounds in the industrial plants. Therefore, it was possible for two totally separated cases to illustrate the interest of simulation software; for neutral spirit production to determine new operation set points in order to maximise productivity and improve quality for neutral spirit production and for bitter orange distillate production, to explain the choice of different cuts and the role of the presence of peels during distillation.

**Keywords:** continuous distillation; batch distillation; simulation; neutral spirit; bitter orange; ProSim<sup>®</sup>

## 1. Introduction

Process simulators are very powerful tools that are scarcely used in food processing (Bon et al., 2009). The two main obstacles for their use in food processing are the lack of data on the different compounds involved and the complexity of the processes (Joulia, 2008).

Among the process simulators used to represent continuous distillation, ProSimPlus is a process engineering software package that performs rigorous mass and energy balance calculations for a wide range of industrial steady-state processes (ProSim, 2012). It was used by Decloux and Coustel (2005) to simulate a typical production plant of neutral spirit, which is a high purity ethanol used in the food, pharmaceutical and chemical industries. The entire distillation plant was comprised of a series of seven columns for concentrating and purifying, and six representative compounds plus ethanol and water were considered. Vapour-liquid equilibrium data were assessed using the UNIQuac Functional-group Activity Coefficient (UNIFAC) modified Dortmund model (Gmehling et al., 1993), a group contribution predictive model available in Simulis Thermodynamics which is the thermodynamic properties and phase equilibria server for ProSim software. Their results allowed them to illustrate the specific role of each column in the sequence of purification steps performed during neutral spirit production. Nevertheless, they did not validate their results on an industrial scale. More recently, Batista and Meirelles (2011) simulated continuous Cachaça production with the Aspen Plus simulation software. They took into account ten compounds plus ethanol and water. The entire representation of the liquid-vapour equilibria by the Non Random Two Liquids (NRTL) model required the knowledge of three binary interaction parameters for each of the sixty six associated binary mixtures. Binary parameters were adjusted for forty-three binary mixtures from literature data. For the others, they used the NRTL parameters available in the Aspen databank or estimations from the UNIFAC predicted values. Simulation results were compared with data from the Santa Adélia Mill plant, which produces 300 m<sup>3</sup> of anhydrous ethanol on a daily basis. Good agreement between the simulated and experimental results made it possible to study the role of several process parameters and the degassing system. The same research group (Batista et al., 2012) validated the simulation of a typical bioethanol distillation process by considering an alcoholic wine with nineteen components. More recently, Valderrama et al. (2012b) used the

ChemCad process simulating software to simulate the behaviour of eight congeners in the production of neutral spirit from beer. They studied more particularly the variation of congeners' behaviour due to variation of the alcohol grade of the feed from 8.3 to 14.8% v/v using the NRTL thermodynamic model. Therefore, they were able to suggest a tool to optimise the positions and flows of lateral extractions.

Concerning the extraction of orange essential oil extraction, the recovery of aroma compounds from orange essential oil was simulated by Haypek et al. (2000) using the commercial steady state software Pro/II and the UNIFAC model for the calculation of vapour-liquid and liquid-liquid equilibria of fourteen compounds plus ethanol and water. Since they obtained good agreement between the Cutrale industrial processing plant and simulated values for the first column used in the recovery of the aroma compounds from the aqueous stream during orange juice evaporation, they used the simulation to study the recovery of the aqueous essence phase.

Simulation of batch distillation is much more difficult than steady state simulation. Osorio et al. (2004) developed a mathematical model for simulating Pisco distillation as a multi-component reactive batch distillation process with reflux. In another study, Osorio et al. (2005) investigated, via process simulation, the operating recipes to obtain a distillate with a maximum of linalool and a minimum of octanoic acid. This recipe was validated with lab-scale experiments. Scanavini et al. (2010) studied Cachaça production in a lab-scale alembic. In that specific case, they modelled the alembic and compared the simulated and experimental results with seven components plus ethanol and water.

As the development of a simulation code is a time consuming task, both for setting up the problem and for solving it, Zamar et al. (2005) recommended the use of a simplified model even if it was less accurate. It is also possible to use commercial simulators. Claus and Berglund (2009) used the ChemCad batch distillation program to model the batch multistage distillation still used to produce fruit spirits. They conducted experiments on the lab-scale (10 L and 150 L stills) and adjusted the simulation parameters to model the distillate flow rate, reflux ratio and ethanol concentration.

The objective of the present work was to check the ability of ProSim® software to model both continuous and batch distillations of two specific industrial units in order to obtain both a better understanding of the behaviour of aroma volatile components

and a tool to optimise the stills' operation. The first part of the present work follows the study of Decloux and Coustel (2005) as it validated the modelling with ProSimPlus software of an industrial plant producing neutral spirit from raw alcohol. In this study, the UNIFAC predictive model was replaced by the NRTL with binary interaction parameters fitted on experimental data from literature. Once the plant was modelled, it first was possible to suggest several modifications of the circuits between the columns and then to use the optimisation capability of the software to search new control set points of the many fluxes between the columns with the view of maximising the productivity by reducing the ratio of low grade alcohol produced. The second part presents a batch distillation simulation with BatchColumn software in order to obtain bitter orange distillate. The aim was to develop a tool to explain the rationale behind the process control parameters, in particular, the choice of the separation of distillate fractions.

## 2. Simulation of the rectification plant of neutral spirit process

### 2.1. Description of the neutral spirit continuous distillation plant

Neutral spirit is produced by distillation from a must obtained by fermentation of diluted beet molasses or beet juice with *Saccharomyces cerevisiae* yeasts. This solution is commonly called wine, regardless of the raw material. The wine, composed mainly of water and ethanol (ethanol mass fraction around 0.08), contains volatile components at a lower concentration than ethanol that are referred to as congeners (esters, alcohols, aldehydes, acids or bases, amines or sulphur compounds). Production of neutral spirit from wine is achieved in two stages: 1) production of a raw alcohol with an ethanol concentration in volume around 93% v/v containing concentrations of volatile congeners that are greater than desired, followed by 2) purification of the raw alcohol by rectification to eliminate the remaining volatile congeners. This last separation unit requires at least four interconnected and energy integrated distillation columns (Decloux and Coustel, 2005). This study focused on the purification stage of raw alcohol. **Figure 1** presents the rectification unit of the industrial plant. It was composed of four columns named C30, C40, C50 and C60 and a liquid-liquid separator (decanter) S60.

### Figure 1

Each column had a specific role. C30 (fifty-two trays) was an extractive distillation column with water as the solvent. In this column, most of the congeners were removed into the head (H30). Water came partly from C40 bottom residue (B40) and partly from demineralised water (DW30). For good separation, Jacques et al. (2003) advised a ratio of nine parts water for one part alcohol. The effectiveness of this extractive column on each congener  $i$  is related to its relative volatility ( $\alpha_{i,\text{ethanol}}$ ) to ethanol. The rectifying column C40 (sixty-seven trays) was used to concentrate the diluted alcohol of the C30 bottom stream (B30) and to eliminate remaining higher alcohols mainly propan-1-ol, 2-methylpropan-1-ol and 3-methylbutan-1-ol. Two side streams, located above the feed tray, were used to extract higher alcohols: the high side draw (HD40) and the low side draw (LD40). As the high volatile congeners not eliminated previously concentrated at the top of the C40 column, a small flux was withdrawn from the head (H40) and neutral alcohol (NA) was withdrawn a few trays below the top and sent to the C50 column. In the plant, the H40 flux is recycled to the raw alcohol tank. In the C50 demethylising column (seventy-seven trays), the methanol content was reduced by stripping at the head of the column (H50). The neutral spirit was recovered at the bottom. In order to minimize ethanol losses, the unit included the congeners concentrating column C60 (sixty trays). It received all the congener-containing streams coming from the other columns, except the H40 stream that returned to the raw alcohol tank. This column was designed to concentrate and eliminate the congeners with a minimum ethanol loss and to recycle, by stream R30, part of the ethanol back to the extractive column C30. The head stream (H60) and high side product stream (HD60) constituted a low grade alcohol sold as a by-product or burned as fuel. The low draw (LD60), which was highly concentrated in 3-methylbutan-1-ol, was sent to the decanter S60, where water (DW60) was added to obtain liquid phase splitting. The decanted fusel oils (FO) may be sold as a by-product and the water phase (WP) was recycled into the C60 column. The low side draw (LD20) from the distillation column receiving the wine was added to the water phase before it was recycled into the C60 column.

The rectifying plant had an average capacity of 1,500 hL of pure alcohol per day (6.7 m<sup>3</sup>/h of raw alcohol at 93% v/v). It worked in triple effects; only C40 and C60 are heated by steam by a reboiler. The C30 column was heated by part of the C40 vapour and the C50 column was heated by the head vapor of the C30 column. The

steam consumption of the distillation plant, including the distillation of the wine to produce the raw alcohol, was 19.63 ton/h (310 kg of steam per hL of pure alcohol). Optimisation of this process was complex because of the numerous liquid connections and the energy integration between the columns. It was decided to focus the work on the liquid connections. The objective of the simulation of the rectifying plant was to obtain a better understanding of the behaviour of the congeners with regard to reducing the loss of alcohol into the low grade alcohol stream without reducing the neutral spirit quality.

## *2.2. Data acquisition in the neutral spirit plant*

The first step of the study was the definition of a nominal point, representative of the steady state operation of the unit, in order to validate the model. Initially, all the circuits and sensors of the plant were checked. The online measurements of pressures, temperatures and flow rates were registered and their hourly averages saved. Some flow rates not registered (LD20, H40, HD40, LD40, H50, H60, HD60, LD60 and DW60) were taken at the time of sampling, which was every hour for eight hours to verify the steady state. Ethanol concentration of the samples in volume percentage (% v/v) was measured with an Anton Paar DMA5000 densitometer, according to the OIV (1994) method. For mass balance, a correlation between ethanol concentration in volume percentage and density was established from Oudin (1980) data. Analyses of the ten selected congeners were carried out with a Varian 3800 series gas chromatograph with the following specifications: capillary column, CP-WAX 57 CB, 50 m × 0.32 mm × 0.2 μm directly interfaced with a flame ionisation detector. The carrier gas was hydrogen at 2 mL/min. Injection was carried out in split mode 1/50 with an injection volume of 1 μL. Temperature of the injector was 210 °C and that of the detector was 240 °C. The temperature program was 4 min at 35°C, then increased by 4.5 °C/min up to 90 °C and then increased by 15 °C/min up to 130 °C. Data were analysed with the Varian WorkStation program. To obtain quantitative results, the internal standard method was applied with 4-methylpentan-2-ol (Tranchant et al., 1982) and six calibration mixtures were prepared. Each sample was analysed in duplicate. Every ten samples, a solution of known concentrations was analysed for quality control. The relative errors between the known concentrations of this solution and the quantified concentrations are displayed in

**Table 1.** Experimental errors were smaller than 2% except for methanol which displayed a relative error of 4.4%.

### Table 1

In order to characterise the nominal point of the rectifying plant, a measurement campaign was carried out during eight hours of stabilized operating point. Every hour, 50 mL of each flux was sampled in order to constitute a representative sample at the end. During the same time, each value of the sensors not digitally recorded was manually read. The concentrations of ethanol and congeners were assessed for the twenty three fluxes sampled. Three series of data collection were carried out.

Measured values and analyses are never completely accurate and there are multiple causes of error. The aim of data reconciliation is to generate a statistically coherent data set from the raw data set and to detect gross errors and possible sensor faults (Vrielynck, 2002). The raw data are adjusted such that the reconciled data satisfy all the mass balances. However, corrections must be coherent with the confidence intervals of the measured data (Mandel et al., 1998). The reconciliation is an optimisation problem within the constraint of the mass balance. The criterion to minimise is the sum of squares of the differences between the measured and corrected values. Relative differences instead of absolute values were chosen due to the large range of flow rate values.

Data reconciliation was initially applied just to satisfy ethanol and total mass balances, using measured total flow rates and ethanol concentrations, and acting on total flow rates only. It seemed important to favour the mass balance of ethanol before considering the other congeners in lower concentrations. Then, the reconciled total flow rates were used for the reconciliation of the mass balance of the congeners by acting on their respective partial flow rates. Relative differences between the measured and reconciled values for ethanol are displayed in **Table 2**. Except for the H50 and WP+LD20 streams, the reconciled values were in good agreement with the measured values (small differences).

### Table 2

Relative differences between the measured and reconciled values for the flow rates of the congeners are displayed in **Table 3**. Except for some particular compounds and flows, the reconciled values have acceptable differences with the measured values.

### **Table 3**

#### *2.3. Simulation procedure with ProSimPlus®*

##### *2.3.1. Thermodynamic models*

The choice of the thermodynamic model for the representation of phase equilibria is fundamental for a reliable process simulation. As the entire process was at low pressure (< 2.5 bar), the vapour phase was considered as an ideal gas and the NRTL activity coefficient model (Renon and Prausnitz, 1968) was chosen to represent the non-ideality of the liquid phase. This model is recommended by Faundez and Valderrama (2004) and Valderrama et al. (2012a). The binary interaction parameters of the binary ethanol-water mixture were estimated from the vapour-liquid equilibrium data of Pemberton and Mash (1978) and Kolbe and Gmehling (1985). The interaction of the ternary ethanol-water-congener mixtures were estimated from the data of Heitz (1960), Williams (1962) and Dechema data bank (Gmehling et al., 1977). For liquid-liquid equilibrium, the set of binary interaction parameters was estimated by Kadir et al. (2008). The interactions between congeners themselves were neglected.

##### *2.3.2. Software Data*

The process model was built using the standard unit modules of ProSimPlus. Then, the chemical compounds and the thermodynamic model were selected from the standard chemical compounds database and the library available in ProSimPlus. Interaction coefficients determined previously were introduced. Simulation was conducted in three steps. First, each column of the industrial plant was modelled separately taking into account the number of real trays, the place of each feed and side draw and the reconciled flow values, and the heat exchanged in the exchangers (reboiler and condenser). Considering only ethanol and water, the efficiencies of the

trays were adjusted to obtain good agreement between the experimental data and simulation results. In the second step, modelling was conducted taking into account the streams integration between the columns. Finally, the ten congener compounds analysed in the experimental part were added into the feeds while maintaining all the other parameters at their previous values.

#### *2.4. Simulation of the neutral spirit plant*

##### *2.4.1. Comparison of simulation results with experimental data*

Comparison between the simulation results of each column separately and the reconciled values are given in **Table 4** for ethanol. The calculated flow rates were in good agreement with the reconciled ones (less than 2% differences) except for the LD60 and H60 streams. This may be explained by the experimental difficulty in assessing ethanol concentration into flows very rich in higher alcohols.

#### **Table 4**

Simulation results of the neutral spirit plant are illustrated in **Figure 2** by the ethanol profiles in each column. The trays are numbered from the bottom to the top, as practised in the plant. For the extractive column C30, it can be observed that the concentrations under the feeds (F30 and R30+DW90) were constant until the third tray on the reboiler. This area of constant concentration was christened as the pinch zone by Unger and Coffey (1975) who indicated that as the ethanol concentration is reduced as the congeners' extraction is improved. Above the feed, there was a significant decrease of ethanol concentration due to the huge feed of water at the top of the column. Owing to this phenomena, the Murphree's efficiencies of the trays above the feed were reduced to 0.29 instead of 0.7 for the other trays of the column.

#### **Figure 2**

##### *2.4.2 Functional analysis of the congeners concentrating column*

The column C60 was very important because the congeners are definitely removed from the system: directly via the head (H60) and the high side stream (HD60, tray 25) and indirectly via the low side stream (LD60, tray 15) sent to the decanter S60 where

the fusel oils (FO) are removed. It can be observed in **Figure 2** that the (WP+LD20) recycle stream fed to tray 10 of the C60 column induced a small increase in ethanol concentration. As the number of trays below this feed is small, it induced a loss of ethanol in the bottom stream (B60); a mass fraction from 0.0016 to 0.0032 was measured. It may also be observed that the higher alcohols were spread on both sides of the feed tray (**Figure 3**) and consequently, there was a lower extraction with the low (LD60) and high side streams (HD60). We tested by simulation the outcome of gathering all the feed streams (H30, HD40, LD40 and WP+LD20) on tray 16 and shifting the low side stream (LD60) to tray 18 instead of 15 (**Figure 4**). These modifications, implemented on the industrial plant, led to a more stable operating mode and a reduction of the ethanol loss. Due to the simulation results, it was possible to convince operators to perform these modifications.

### Figure 3

### Figure 4

#### 2.4.3 Sensitivity analysis and optimisation

In addition to furthering better understanding of the behaviour of the volatile congeners in the four columns, the purpose of the simulation was also to optimise the production. Optimisation was carried out on the basis of an economic criterion (maximising the profit equal to sales income of neutral spirit and low grade alcohol) with quality constraints for the neutral spirit and the low grade alcohol (ethanol and congeners concentrations). Only modifications of streams flow rates were considered, the other parameters remained constant. The problem was solved by using the Successive Quadratic Programming method available within ProSimPlus®.

Sensitivity analysis was used to determine how “sensitive” the objective function was to changes of action variables. Seven total flow rates were studied: DW30, H30, H40, HD40, H50, H60 and HD60. Their influence on the neutral spirit quality, characterised by its propan-1-ol concentration and on the profit related to the ratio of low grade alcohol produced, is represented in **Figure 5**. Neutral spirit quality was particularly sensitive to the DW30, H40 and HD40 flow rates. Profit was very sensitive to the H60 and HD60 flow rates and less so to H50.

**Figure 5**

Finally, optimisation variables taken into account were only the more sensitive ones (DW30, HD40, H50, H60 and HD60). Optimisation flows are summarised in **Table 5**. The optimal point moved significantly from the nominal one (variation of more than 30% for some flux). It can be observed that the demineralised water stream fed into the extractive column (DW30) was increased by 18.7%, which allowed a better extraction of the congeners into the distillate. As the flows extracted from the congeners concentration column, H60 and HD60, decreased (30.5% and 36.2% respectively), the production of low grade alcohol decreased, allowing a productivity gain of 0.83% calculated with the sales price of neutral spirit and low grade alcohol.

**Table 5 and 6**

Optimisation also achieved a reduction of the concentration of propan-1-ol in the neutral spirit (from 77.3 ppm to 5 ppm), which is proof of better quality (**Table 6**). The evolution of the optimisation variables was coherent with the sensitivity analysis.

The operating conditions were modified in small increments towards achieving the optimal set points and this work is in progress.

**3. Modelling of the distillate from orange peels***3.1. Bitter orange distillate batch distillation plant*

The bitter orange distillate production took place in a French beverage company. The four copper stills in the plant (**Figure 6**) were composed of a boiler (load of 72 hL), a column with six capped trays and a total cooling condenser and cooler feed with cold water at 12 °C.

**Figure 6**

The raw material that was distilled was composed of the flavedo of bitter orange peels macerated for three weeks in neutral alcohol diluted at 30% v/v plus the heads and tails cuts from the previous distillation and water to cover the peels. The mass of liquid was around 5.4 tons per distillation.

An entire distillation took approximately ten hours. The first drops of distillate appeared at the end of one hour of heating. Three different fractions of distillate were separated according to either the ethanol concentration, or the cumulative distillate volume. The split criterion was based on the empirical skills of the distillery. The first fraction is the heads cut, which is in fact separated into two fractions: the first twenty litres were decanted to discard the light phase and to recycle the heavy phase to the heads receiver and the following volume was directly sent to the heads receiver. The second fraction was the heart cut named bitter orange distillate, which corresponded to the most pleasant fraction. This heart cut was the aromatic ingredient added into the bitter orange spirit. The third fraction was the tails cut collected in the same receiver as the heads, to be recycled in the following distillation. After cooling, the still was emptied, rinsed with water and recharged for the subsequent distillation the following morning.

### *3.2. Data acquisition of the bitter orange distillate plant*

The study was conducted on one alembic constructed in 1990 by Prulho, France. First, all the circuits and sensors were checked. The alembic is equipped with a series of sensors. In the cooling distillate, there was a densitimeter (7830 from Schlumberger, Germany) a temperature sensor (Pt100) and flow meter (Heliflux Faure-Hermann H05INCT). On the reflux line there was a flow meter (Heliflux Faure-Hermann, H2INCT). In the vapour in the swan neck, there was a temperature sensor (Pt100) and pressure gauge (OTI). For the heating steam, there was a pressure gauge (OTI series Z). The calculator assessed from the measurements on distillate flow the ethanol concentration (in %v/v) at 20 °C, the cumulative distillate volume and total ethanol volume. The data acquisition system of the plant was designed to record the parameters every six minutes.

Three distillation runs were followed. Nine distillate samples of 100 mL were collected in glass bottles over each distillation: three samples at the beginning, the middle and the end of each cut. For the purpose of this study, a specific tank was added to collect the two fractions of heads separately. As heads cut samples

separate into an oil phase rich in terpene and an aqueous phase, these samples were diluted in absolute ethanol for analysis. All samples were stored at -20 °C.

In a previous study, Deterre et al. (2012a) detected and quantified the volatile compounds of a heart cut and characterised their odour by using GC-Olfactometry. In total, forty molecules were detected in the heart cut and among them seven were selected by nine trained panellists using the GC-olfactometry and frequency method. For this study, four molecules were selected because of their concentration or their odour impact: two monoterpene hydrocarbons ( $\alpha$ -pinene and D-limonene) and two oxygenated hydrocarbons (linalool and linalool oxide). Analyses of the aroma compounds plus ethanol were carried out with an Agilent Technologies 6890 GC and an apolar capillary DB-5 (5% diphenyl/95% dimethyl siloxane) column 30 m long, 0.320 mm I.D. and 0.5  $\mu$ m film thickness, directly interfaced with a flame ionisation detector and helium carrier gas (flow rate 1 mL/min). The temperatures of the injector and the detector were 240 °C. For all components except limonene, injections of 1  $\mu$ L were made in splitless mode and the temperature program was 1 min at 50 °C then increased by 10 °C/min up to 80 °C, then increased by 3 °C/min up to 130 °C, then increased by 5 °C/min up to 240 °C and finally increased by 7 °C/min up to 270 °C, hold 3 min. For limonene injections of 1  $\mu$ L were made in split mode (1/50) and the temperature program was 1 min at 50 °C then increased by 10 °C/min up to 80 °C, then increased by 3 °C/min up to 120 °C, and finally increased by 20 °C/min up to 270 °C, hold 3 min. The software MSD ChemStation Data Analysis (Rev D) from Agilent was used for control, general operations and data acquisition of the results.

For purposes of quantification, internal standard solutions of nonane and tridecane were added. A mixture of four aroma compounds of bitter orange was prepared with distilled water and absolute ethanol as solvents. Response factors of each compound were thus determined. All samples were analysed three times. Averages and standard deviations of the mass fractions of the four aroma compounds over the three distillations of all cut samples are displayed in **Table 7**.

### **Table 7**

It can be seen that sometimes the standard deviations were high compared with the averages. According to Can Baser (2010), this was due to the fact that the essential oil produced by distillation with an alembic can have a very variable composition at

each distillation. Despite these variations, it can be observed that terpene molecules ( $\alpha$ -pinene and D-limonene) went out in the first fraction of distillate (heads); whereas, linalool and linalool oxide arrive in the last fraction (tails). It was checked whether the presence of linalool and linalool oxide into the first fraction was due to liquid remaining in the dead volume from the previous distillation.

### 3.3. Batch distillation modelling with BatchColumn

#### 3.3.1. Thermodynamic models

A previous study by Deterre et al. (2012b) reported vapour-liquid equilibrium measurements of the four compounds ( $\alpha$ -pinene, D-limonene, linalool and linalool oxide) in alcoholic solutions of different ethanol concentrations and the choice of the thermodynamic model. The water-ethanol VLE data were assessed with the NRTL model and the binary interaction parameters available in the ProSim databank because the parameters fitted during the neutral spirit study were the property of the industrial partners. However, results obtained with these two sets of binary interaction parameters were similar. The four aroma compounds were represented by a Henry's law type model by Deterre et al. (2012b) as it gave the best representation of experimental data. Parameters are reported in **Table 8**.

### Table 8

#### 3.3.2. Software Data

The structure of the alembic (column with six capped trays and total condenser), the receivers to collect the three cuts (heads, heart and tails) and the control parameters were chosen according to experimental data using BatchColumn software. As the condenser and the capped trays of the column contained liquid before start-up (from the previous run), their volumes and ethanol composition were measured in the industrial plant and registered. The temperature of the condensed vapour (reflux and distillate) was fixed at 20 °C and the pressure drop of the column at 18 mbar. The mass of the charge (5,462 kg) in the pot still, calculated from mass balance into the plant, is reported in **Table 9**.

### Table 9

One distillation run was represented by a sequence of different operating steps. An initial step, called the filling step, was created to represent the alembic heating phase. The initial temperature of the charge was fixed at 25 °C and the heat flux was fixed at 372 kW in order to represent the time necessary to reach the boiling point of the charge (one hour). According to experimental data, appropriate events for each step were programmed to take into account the variation of distillate flow rate and reflux ratio set points over time (**Figure 7**) and to separate the cuts (**Table 10**). It was difficult during the distillation of the tails to represent precisely the continuous variation of the distillate flow rate and the reflux ratio despite the five steps used to represent this task.

### **Figure 7**

### **Table 10**

As in the previous study, tray efficiencies were modified to obtain good agreement of the profile of distillate ethanol concentration over time with experimental data. Efficiencies were chosen at 0.6, except for the highest tray, which was set at 0.4 because of the reflux flow that arrived at 20 °C.

#### *3.4. Comparison of simulation results with experimental data*

**Figure 8** compares the simulation results and experimental ethanol concentration profiles in the distillate. **Table 11** compares the characteristics (duration, volume and ethanol volume) of the three cuts.

### **Figure 8**

### **Table 11**

The experimental and simulated values were in very good agreement for the heart cut, which is the most important cut. As the heads run in a very short period, it was difficult to adjust the simulation parameters accordingly. Despite the difficulty to

represent the continuous variation of the parameters during the tails, a quantitative match between experimental and simulation data was mostly attained. Moreover the volumes remaining in the pot still at the end of the distillation in the plant (3,563 L) and from the simulation (3,865 L) were close.

Then, the behaviour of the four aroma compounds was observed. The aim was to compare the profiles of the four compounds, particularly if they were detected in the same periods of time (**Figure 9 and Figure 10**).

### **Figure 9**

### **Figure 10**

Regarding the mass fractions of the four aroma compounds, it can be concluded that their behaviour was well represented by the simulation in comparison with the actual distillation carried out in the distillery. The two monoterpene hydrocarbons (Figure 9) were also detected in the heads cut and the oxygenated compounds (Figure 10) in the tails cut. Concerning the monoterpene hydrocarbons and the linalool profiles, we observed that they were detected for a longer period of time in the experimental profiles compared with the simulated profiles. This was because the software does not simulate the effect of the peels present in the boiler. Indeed, it was demonstrated by experimental distillation without peels that they do not immediately release the limonene they contain and thus delay its distillation.

Moreover, as the parameters of the chemical reactions were unknown, the linalool oxide profile (from linalool degradation) was simulated by adding linalool oxide in the initial charge of the boiler ( $3 \cdot 10^{-5}$  in mass fraction). A time difference between the simulated and experimental profiles was also observed, which was due to the peels being in the boiler and the fact that the linalool degradation reaction did not take place in the simulation.

All these results confirm the choice of the thermodynamic model to represent the aroma compounds. We concluded that the simulation results were correct from a quantitative as well as a qualitative point of view.

#### 4. Conclusion

Concerning the production of neutral spirit, the model validation required a precise functional analysis of the plant. Thus, all circuits and sensors were first checked and several problems were corrected. Then, the reconciled mass balances were generated from raw data as reference. Simulation results were very satisfactory. Simulation enables the visualisation of all the congeners' profiles and thus facilitates the understanding of their behaviours and suggestions for improvements. Modifications implemented for the low grade concentration column (C60) allowed much better operation. Due to the optimisation, changes resulting in maximal recovery of ethanol into spirit were indicated.

Concerning the production of the heart cut from macerated orange peels distillation, a correct modelling procedure of pot still distillation allowed for improvements in the selection of distillate cuts, considering the product quality, the maximal recovery of ethanol in the heart fraction (spirit) and the energy consumption.

Results presented in this paper demonstrate that it is possible to simulate the operation of continuous and batch beverage distillation plants using commercial process simulation software. The use of validated process simulation is a powerful tool to analyse the operation of a plant and to modify plant operating parameters in order to increase both product quality and efficiency.

#### References

- Batista, F.R.M., & Meirelles, A.J.A. (2011). Computer simulation applied to studying continuous spirit distillation and product quality control. *Food Control*, 22, 1592-1603.
- Batista, F.R.M., Follegatti-Romero, L.A., Bessa, L.C.B.A., & Meirelles A.J.A. (2012). Computational simulation applied to the investigation of industrial plants for bioethanol distillation. *Computers and Chemical Engineering*, 46, 1–16.
- Bon, J., Clemente, G., Vaquiro, H., & Mulet, A. (2009). Simulation and optimization of milk pasteurization processes using general process simulator (ProSimPlus). *Computers and Chemical Engineering*, 34, 414–420.
- Can Baser, K.H., Buchbauer, G. (2010). Handbook of essential oils Science, Technology and Applications, Boca Raton, Taylor&Francis Group, 975 p

- Claus, M.J., & Berglund, K.A. (2009). Defining still parameters using chemcad batch distillation model for modelling fruit spirits distillations. *Journal of Food Process Engineering*, 32, 881-892.
- Decloux, M., & Coustel, J. (2005). Simulation of a neutral spirit production plant using beer distillation. *International Sugar Journal*, 107(1223), 628-643.
- Deterre, S., Rega, B., Delarue, J., Decloux, M., Lebrun, M., & Giampaoli, P. (2012a). Identification of key aroma compounds from bitter orange (*Citrus aurantium* L.) products: essential oil and macerate–distillate extract. *Flavour Fragrance Journal*, 27, 77–88.
- Deterre, S., Albet, J., Joulia, X., Baudouin, O., Decloux, M., & Athès, V. (2012b). Vapour-liquid equilibria measurements of bitter orange aroma compounds at infinite dilution in boiling hydro-alcoholic solutions at 101.3 kPa. *Journal of Chemical Engineering Data*, 57, 3344-3356.
- Faundez, C.A., & Valderrema, J.O. (2004). Phase equilibrium modeling in binary mixtures found in wine and must distillation. *Journal of Food Engineering*, 65, 577-583.
- Gmehling, J., Onken, U., & Arlt, W. (1977). Vapor-liquid equilibria data collection. Chemistry data series, Francfort.
- Gmehling, J., Jiding, L., & Schiller M. (1993). A modified UNIFAC model. 2. present parameter matrix and results for different thermodynamic properties. *Industrial & Engineering Chemistry Research*, 32, 178-193
- Haypek, E., Silva, L.H.M., Batista, E., Marques, D.S., Meireles M.A.A., & Meirelles A.J.A. (2000). Recovery of aroma compounds from orange essential oil. *Brazilian Journal of Chemical Engineering*, 17, 4-7, 705-712.
- Heitz, J.E. (1960). Measurement of vapor-liquid equilibria for acetaldehyde-ethanol-water mixtures. *American Journal of Enology & Viticulture*, 11(1), 19-29.
- Jacques, K.A., Lyons, T.P., & Kelsall, D.R. (2003). The alcohol textbook. 4th ed. University press: Nottingham.
- Joulia, X. (2008). Simulateurs de procédés. *Techniques de l'ingénieur*, chapitre J, 1-25.
- Kadir, S., Decloux, M., Giampaoli, P. & Joulia, X. (2008). Liquid-liquid equilibria of the ternary systems 3-methyl-1-butanol + ethanol + water and 2-methyl-1-propanol + ethanol + water at 293.15 K., *Journal of Chemical Engineering Data*, 53, 910-912.

- Kolbe, B., & Gmehling, J. (1985). Thermodynamic properties of ethanol + water. I. Vapour-liquid equilibria measurements from 90 to 150°C by the static method. *Fluid Phase Equilibria*, 23, 213-226.
- Mandel, D., Abdollahzadeh, A., Maquin, D., & Ragot, J. (1998). Data reconciliation by inequality balance equilibration: a LMI approach. *International Journal of Mineral Processing*, 53, (3), 157-169.
- Osorio, D., Perez-Correa, R., Belanci, A., & Agosin, E. (2004). Rigorous dynamic modeling and simulation of wine distillations. *Food Control*, 515-521
- Osorio, D., Perez-Correa, R., Biegler, L., & Agosin E. (2005). Wine distillates : practical recipe formulation for stills. *Journal of Agricultural and Food Chemistry*, 53, 6326-633
- OIV, (1994). Recueil des méthodes internationales d'analyse des boissons spiritueuses, des alcools et de la fraction aromatique des boissons, Paris.
- Oudin, P., (1980). Guide pratique d'alcoométrie. ed Oudin, Poitiers.
- Pemberton, R.C., & Mash, C.J. (1978). Thermodynamic properties of aqueous non-electrolyte mixtures II. Vapour pressures and excess Gibbs energies for water + ethanol at 303.15 to 363.15 K determined by an accurate static method. *The Journal of Chemical Thermodynamics*, 10(9), 867-888.
- ProSim (2012). <http://www.prosim.net>
- Renon, H., & Prausnitz, J.M. (1968). Local compositions in thermodynamic excess functions for liquid mixtures. *AIChE Journal*. 14(1), 135-168.
- Scanavini, H.F.A., Ceriani, R., Cassini, C.E.R., Souza, E.L.R., Filho, F.M., & Meirelles, A.J.A (2010). Cachaça production in a lab-scale alembic: modeling and computational simulation. *Journal of Food Engineering*, (33), 226-252.
- Tranchant, J., Gardais, J.F., Gorin, P., Prévôt, A., Serpinet, J., & Untz, G. (1982). Manuel pratique de chromatographie en phase gazeuse. 3 ed., Masson, Paris.
- Unger, E.D., & Coffey, T.R. (1975). Production of light-bodied rum by an extractive distillation process. *Annales de Technologies Agricoles*, 24, 469-495.
- Valderrama, J.O., Faundez, C.A., Toselli, L.A. (2012a). Advances on modeling and simulation of alcoholic distillation. Part 1: Thermodynamic modeling. *Food and Bioproducts Processing*, 90, 819-831
- Valderrama, J.O., Toselli, L.A., Faundez, C.A., (2012b). Advances on modeling and simulation of alcoholic distillation. Part 2: Process simulation. *Food and Bioproducts Processing*, 90, 8832-840.

- Vrielynck, B. (2002). Les procédés mieux maîtrisés grâce à la réconciliation de données, *Mesures*, 741, 30-34.
- Williams, G.C. (1962). Vapor-Liquid equilibria of organic homologues in ethanol-Wwater solutions. *American Journal of Enology and Viticulture*, 13, 169-182.
- Zamar, S.D., Salomone, H.E., Iribarren, O.A. (2005). Operation planning in the rectification of essential oils. *Journal of Food Engineering*, 69:207-215.

Accepted Manuscript

This study proves interest of simulation to optimise neutral spirit distillation plant

Neutral alcohol quality was improved and yield increased

Simulation explains aroma compounds behaviour in bitter orange distillate production

Both industrial applications included selection of compounds and process balance

Simulations included selection or measurement of L/V or L/L equilibria data

Accepted Manuscript

Table 1 - Relative errors (%) of the GC analysis method of the congeners' mass contents.

Compound	%	Compound	%	Compound	%	Compound	%
Acetaldehyde	0.3	Methanol	4.4	Butan-1-ol	0.1	2-methylpropan-1-ol	0.03
Ethyl acetate	1.8	Butan-2-ol	0.4	Allyl alcohol	1.3	3-methylbutan-1-ol	0.2
Acetal	-0.7	Propan-1-ol	0.7				

Table 2 - Relative differences (%) between measured and reconciled values for ethanol flow rates.

Flow	(%)	Flow	(%)	Flow	(%)	Flow	(%)
H30	0.02	H40	0.32	H50	28.9	H60	6.82
F30	4.44	NA	4.24	Neutral spirit	0	HD60	6.46
R30	2.27	HD40	0.65			LD60	6.11
B30	7.31	LD40	0.18			WP+LD20	21.8
		B40	<sup>(1)</sup>			B60	<sup>(1)</sup>

(1) non measured flow rates

Table 3 - Relative differences (%) between measured and reconciled values for congeners mass flow rates.

Flow	Acetaldehyde	ethyl acetate	Acetal	Methanol	butan-2-ol	propan-1-ol	butan-1-ol	allyl alcohol	2-methylpropan-1-ol	3-methylbutan-1-ol
H30	13.6	18.2	1783.5	-	5.4	1.1	3.0	18.9	1.9	4.2
F30	23.0	21.8	2.7	1.3	92.2	63.1	-	64.6	3.9	6.1
R30	26.6	3.2	18.1	50.0	0.7	34.1	0.0	0.0	9.9	-
B30	0.0	0.0	0.0	-	0.0	12.1	-	0.0	20.0	13.7
H40	6.3	-	-	0.1	-	0.0	0.0	-	0.0	0.0
NA	-	-	-	0.2	-	0.0	0.0	-	0.0	0.0
HD40	0.0	-	-	0.0	-	2.5	0.2	-	9.8	0.7
LD40	22.0	-	-	0.0	-	2.0	3.5	-	17.5	15.1
H50	14.4	-	-	13.8	-	-	-	-	-	-
Neutral spirit	0.0	-	0.0	0.0	0.0	0.0	0.0	0.0	0.0	0.0
H60	23.0	0.0	0.3	7.7	0.0	0.0	0.0	-	0.0	0.0
HD60	11.9	0.0	0.0	0.0	0.0	2.7	0.2	19.7	10.5	1.0
LD60	34.7	0.0	0.0	0.0	0.0	1.9	1.0	58.1	11.0	8.8
WP+LD20	14.4	0.0	0.1	0.0	0.0	2.0	1.0	-	11.5	12.0

Table 4 - Relative differences (%) between reconciled data and simulation results for ethanol mass flow rates.

Flow	(%)	Flow	(%)	Flow	(%)	Flow	(%)
H30	( <sup>1</sup> )	H40	0.52	H50	0.71	H60	1.67
F30	( <sup>1</sup> )	NA	0.16	Neutral spirit	-0.04	HD60	10.3
R30	1.39	HD40	-2.18			LD60	-50.0
B30	0.00	LD40	0.00			WP+LD20	( <sup>1</sup> )
		B40	( <sup>1</sup> )			B60	( <sup>1</sup> )

(<sup>1</sup>) fixed values for simulation

Table 5 - Comparison of the initial fluxes before optimisation (nominal) and after.

	Before optimisation	After optimisation	
	Flow	(kg.h <sup>-1</sup> )	Variation (%)
DW30	56,800	67,400	18.7
HD40	538	700	30.1
H50	290	400	38.0
H60	128	89	-30.5
HD60	141	90	-36.2

Table 6 - Comparison of concentrations of ethanol and propan-1-ol before (nominal) and after optimisation.

Concentration in neutral spirit	Before optimisation	After optimisation
propan-1-ol (ppm)	77.3	5.0
Ethanol (w/w)	0.9415	0.9425

Table 7 - Averages and standard deviations of mass fractions of the aroma compounds over three distillations in the three cuts of distillate (nd as not detected).

		Mean of the mass fractions $\pm$ standard deviation			
Cut		$\alpha$ -pinene ( $\times 10^{-5}$ )	D-limonene ( $\times 10^{-3}$ )	Linalool ( $\times 10^{-4}$ )	Linalool oxide ( $\times 10^{-5}$ )
Heads	Beginning	5.6 $\pm$ 3.2	9.1 $\pm$ 6.5	1.7 $\pm$ 0.3	4.1 $\pm$ 0.6
	Middle	55.7 $\pm$ 10.2	60.6 $\pm$ 5.6	1.0 $\pm$ 0.02	3.9 $\pm$ 0.2
	End	108 $\pm$ 24	102.0 $\pm$ 9.1	0.2 $\pm$ 0.02	0.7 $\pm$ 0.1
Heart	Beginning	64.2 $\pm$ 24.1	64.4 $\pm$ 11.3	0.03 $\pm$ 0.006	0.1 $\pm$ 0.03
	Middle	2.5 $\pm$ 0.2	3.6 $\pm$ 0.3	0.05 $\pm$ 0.002	0.2 $\pm$ 0.02
	End	1.4 $\pm$ 0.2	2.7 $\pm$ 0.1	1.1 $\pm$ 0.1	6.2 $\pm$ 1.1
Tails	Beginning	1.4 $\pm$ 0.1	2.6 $\pm$ 0.1	1.7 $\pm$ 0.1	15.0 $\pm$ 2.3
	Middle	nd	1.4 $\pm$ 0.5	3.2 $\pm$ 1.9	86.8 $\pm$ 42.6
	End	nd	0.09 $\pm$ 0.02	1.5 $\pm$ 1.0	38.2 $\pm$ 23.9

Table 8 - Henry's Constants A' and B' (from equation  $\ln H_i = A' + B'/T$ ) of the aroma expressed in Pa with respect to the aroma mole fraction (Deterre et al., 2012b).

compounds	A'	B'
$\alpha$ -pinene	288.87	- 97,207
D-limonene	305.82	- 103,438
linalool	168.20	- 56,072
linalool oxide	137.23	- 45,088

Table 9 - Initial composition of the charge in the pot still expressed as mass fractions for all the compounds.

Compounds	Mass fractions in the initial charge	Charge in the still (kg)
Water	0.7899	
Ethanol	0.2087	
$\alpha$ -pinene	1.71 $\times 10^{-5}$	
D-limonene	1.27 $\times 10^{-3}$	5,462
Linalool	9.34 $\times 10^{-6}$	
Linalool oxide	3 $\times 10^{-5}$	

Table 10 - End events and values of distillate flow and reflux ratio for the simulation steps

	Cut	Reflux ratio	Distillate flow (kg.h <sup>-1</sup> )	End event of the step
Step 1	Heads	2.5	160	13.92 kg of distillate
Step 2	Heads	3.65	170	Ethanol mass fraction in distillate = 0.8000
Step 3	Heart	3.65	170	Ethanol mass fraction in distillate = 0.8573
Step 4	Heart	3.56	200	Ethanol mass fraction in distillate = 0.8559
Step 5	Tails	2.5	198	Ethanol mass fraction in distillate = 0.7000
Step 6	Tails	1.7	220	Ethanol mass fraction in distillate = 0.4000
Step 7	Tails	1.2	220	Ethanol mass fraction in distillate = 0.2000
Step 8	Tails	0.7	260	Ethanol mass fraction in distillate = 0.0500
Step 9	Tails	0.1	210	Ethanol mass fraction in distillate = 0.0358

Table 11 - Comparisons between experimental data (exp), simulated ones (sim) and relative differences (%)

	Duration (h)			Distillate volume (L)			Distillate volume of ethanol (L)		
	exp	sim	%	exp	sim	%	exp	sim	%
Heads	0.42	0.2	-52.4	68	45	-33.8	48	25	-47.9
Heart	4.82	4.73	-1.9	1,145	1,171	2.3	1,050	1,047	-0.3
Tails	3.12	3.4	9.0	721	851	18.0	294	363	23.5
total	8.36	8.33	-0.4	1,934	2,067	6.9	1,392	1,435	3.1

Fig.1 - Process diagram of the neutral spirit plant.

Fig. 2 - Plots of ethanol concentration as a function of real stage number for (a) C30, (b) C40, (c) C50 and (d) C60. Plot (e) shows a magnified section of plot (d). Discrete points represent solutions calculated on each stage with lines joining data points used for visual guidance only.

Fig. 3 - Profiles of the concentration of ethanol (left side) and congeners (right side) in the congeners concentrating column C60 with two separate feeds (one in tray 16 with collected flows H30+HD40+LD40 and one in tray 10 with collected flows WP+LD20) and extraction of LD60 on tray 15.

Fig. 4 - Profiles of the concentration of ethanol (left side) and congeners (right side) in the congeners concentrating column C60 with all feeds H30 + HD40 + LD 40 +WP+LD20 on tray 16 and extraction of LD60 on tray 18.

Fig. 5 - Variation of (a) neutral spirit quality and (b) profit gain variation as a function of the percentage variation of key flow rates from their nominal value.

Fig. 6 - Scheme of the 72 hL orange spirit still.

Fig. 7 - Plot of (a) reflux ratio and (b) distillate flow rate as a function of time. Discrete data points represent plant data and solid lines represent simulation values.

Fig.8 - Comparison of the change over time of distillate ethanol mass fractions in three trials (data points) vs. the simulation model (solid line). Dotted lines indicate separation of cuts by simulation.

Fig. 9 - Comparisons of  $\alpha$ -pinene (a) and D-limonene (b) behaviours of three trials (data points) vs. the simulation model (solid line). Dotted lines indicate separation of cuts by simulation.

Fig. 10 - Comparisons of linalool (a) and linalool oxide (b) behaviours of three trials (data points) vs. simulation model (solid line). Dotted lines indicate separation of cuts by simulation.

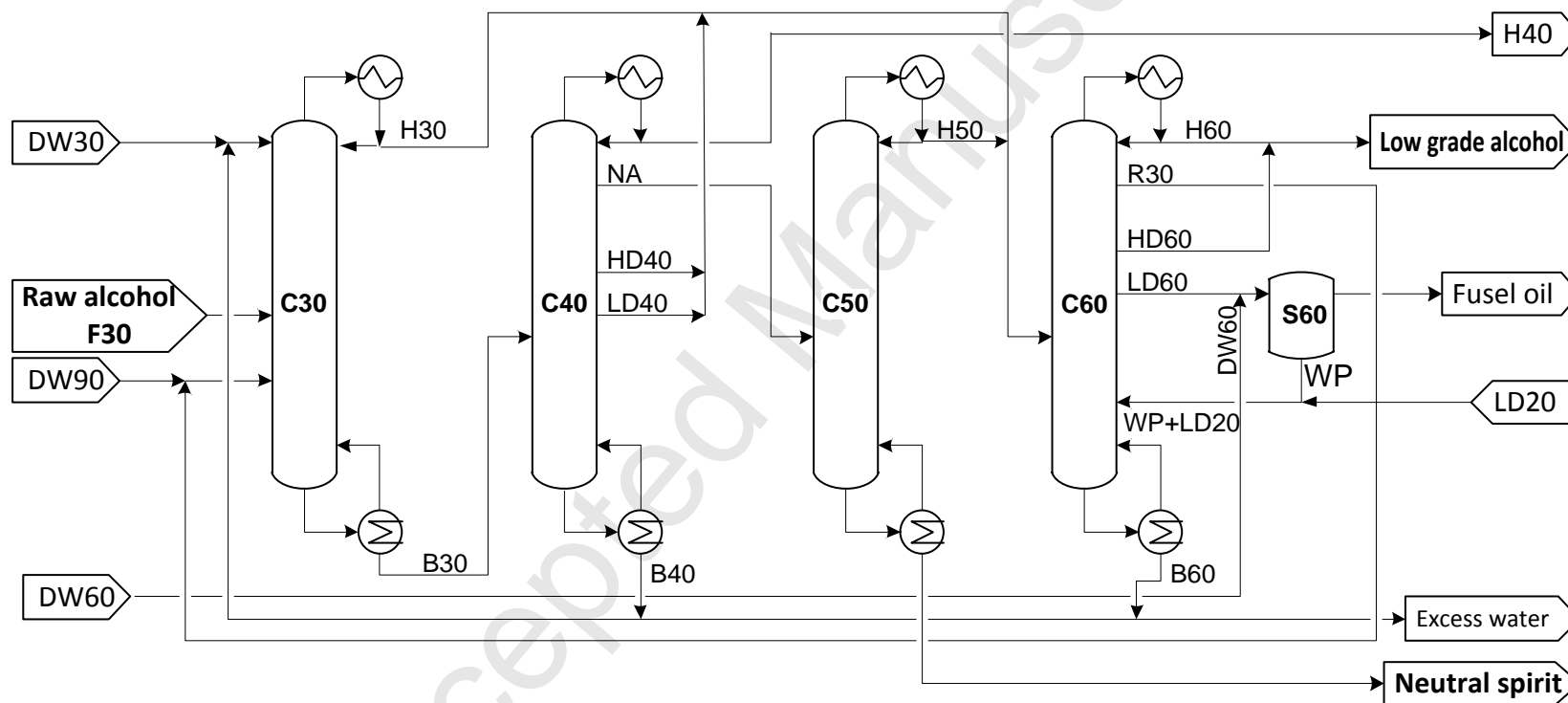

Fig.1 - Process diagram of the neutral spirit plant.

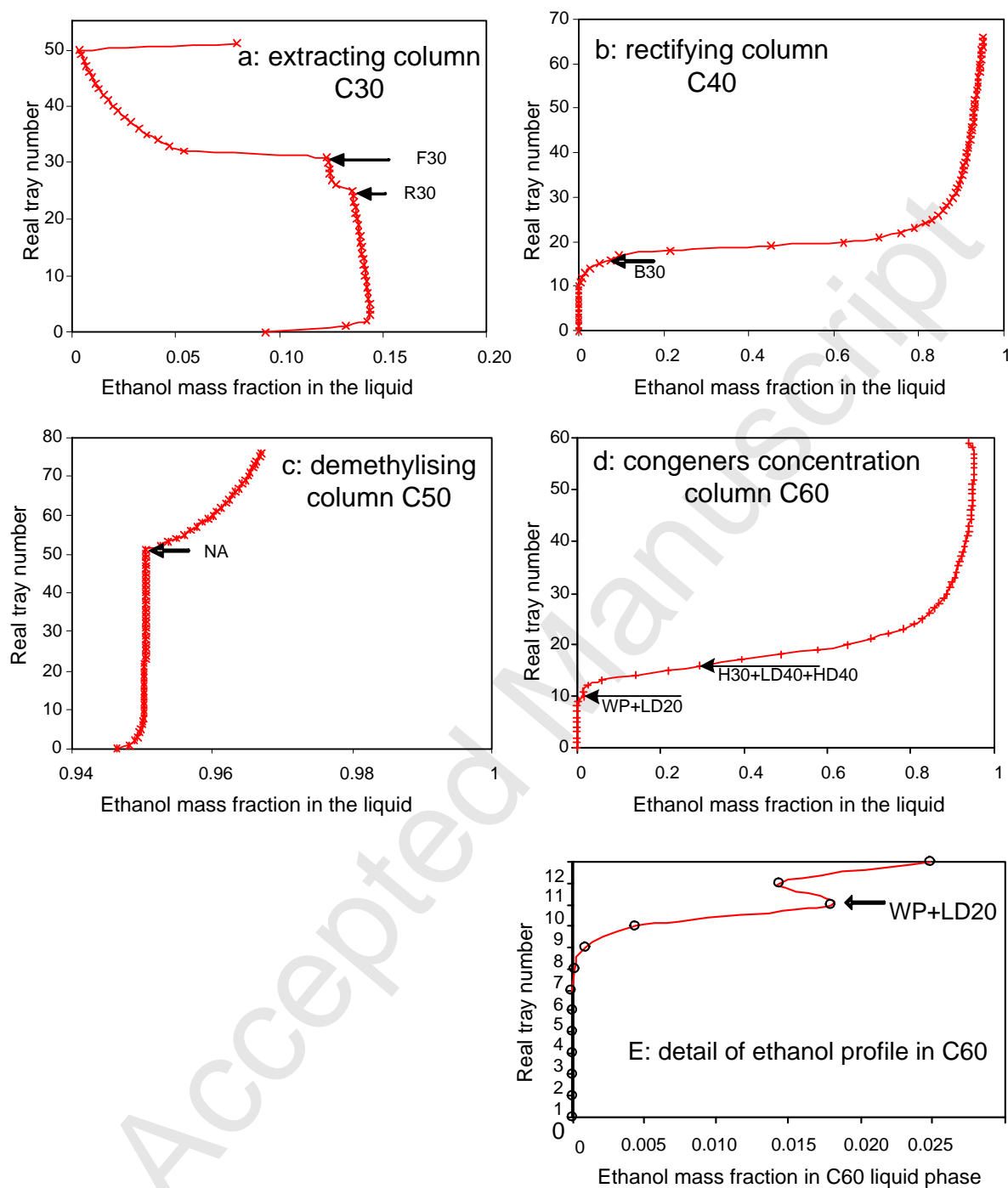

Fig. 2 - Plots of ethanol concentration as a function of real stage number for (a) C30, (b) C40, (c) C50 and (d) C60. Plot (e) shows a magnified section of plot (d). Discrete points represent solutions calculated on each stage with lines joining data points used for visual guidance only.

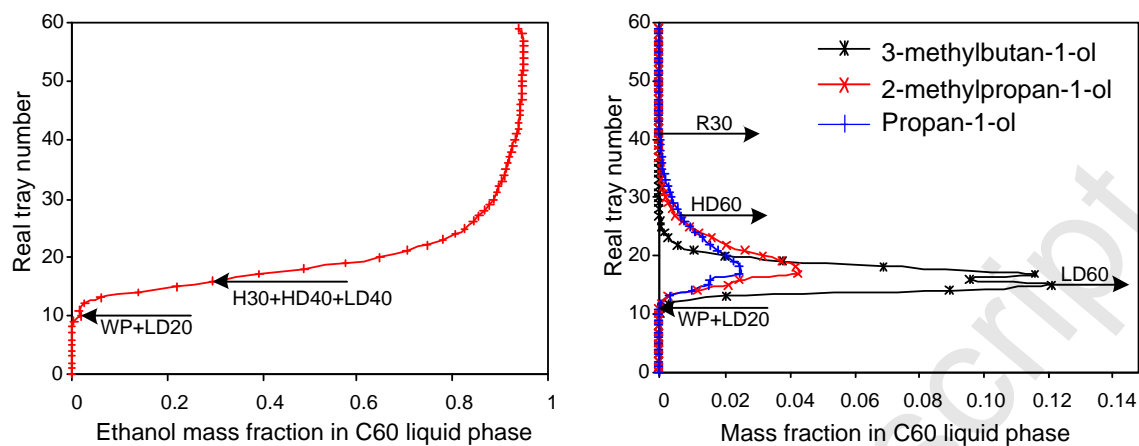

Fig. 3 - Profiles of the concentration of ethanol (left side) and congeners (right side) in the congeners concentrating column C60 with two separate feeds (one in tray 16 with collected flows H30+HD40+LD40 and one in tray 10 with collected flows WP+LD20) and extraction of LD60 on tray 15.

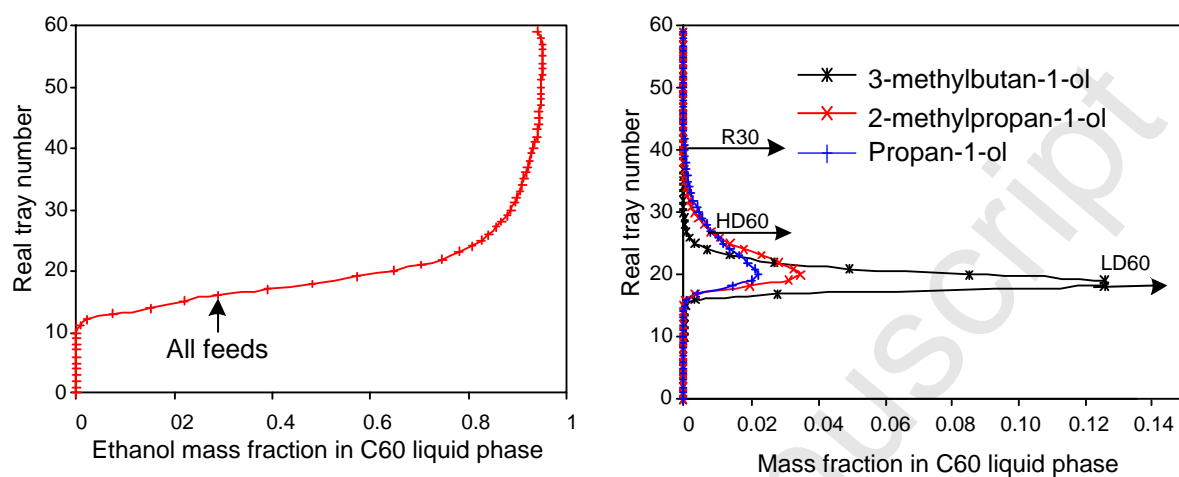

Fig. 4 - Profiles of the concentration of ethanol (left side) and congeners (right side) in the congeners concentrating column C60 with all feeds H30 + HD40 + LD 40 + WP + LD20 on tray 16 and extraction of LD60 on tray 18.

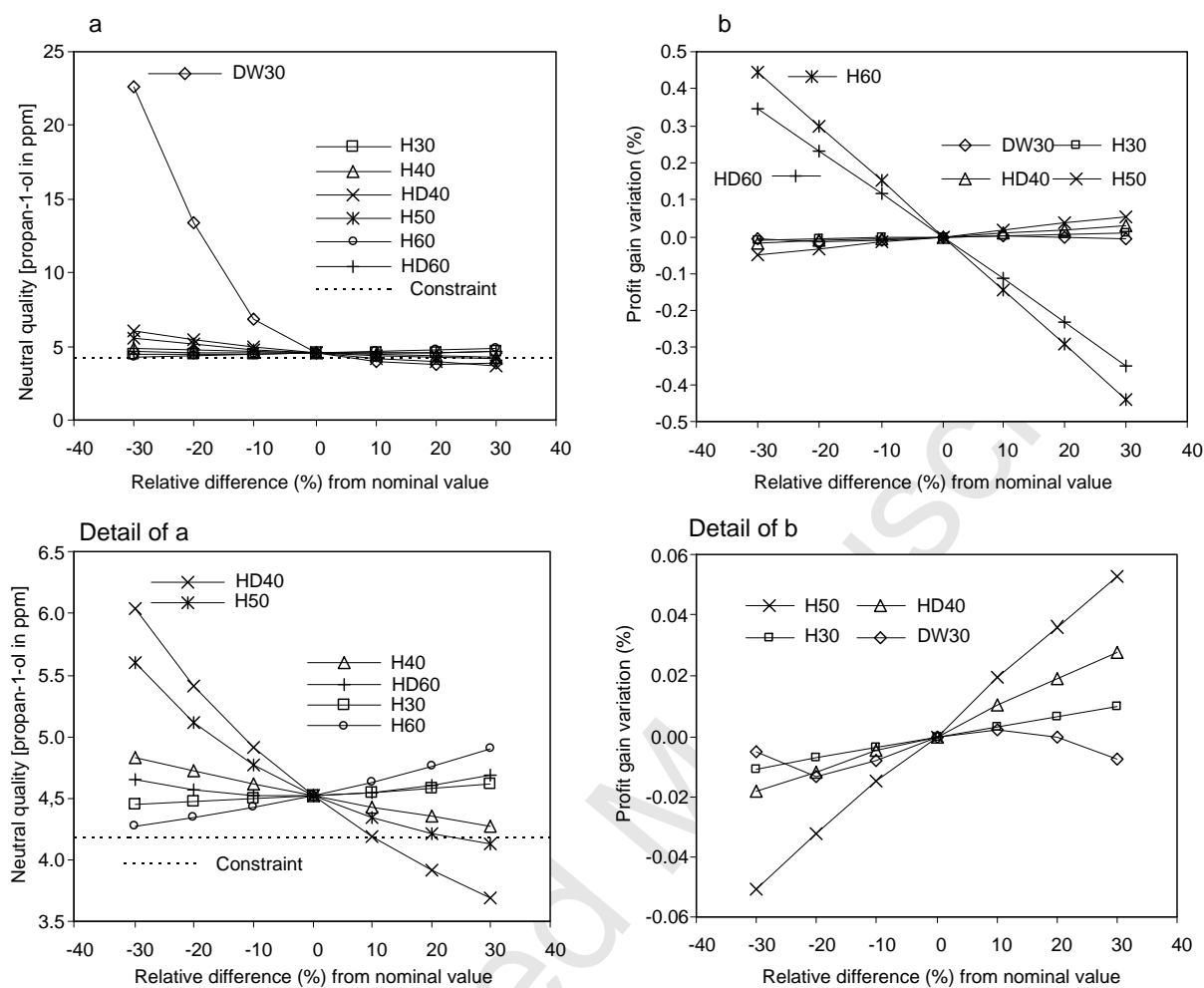

Fig. 5 - Variation of (a) neutral spirit quality and (b) profit gain variation as a function of the percentage variation of key flow rates from their nominal value.

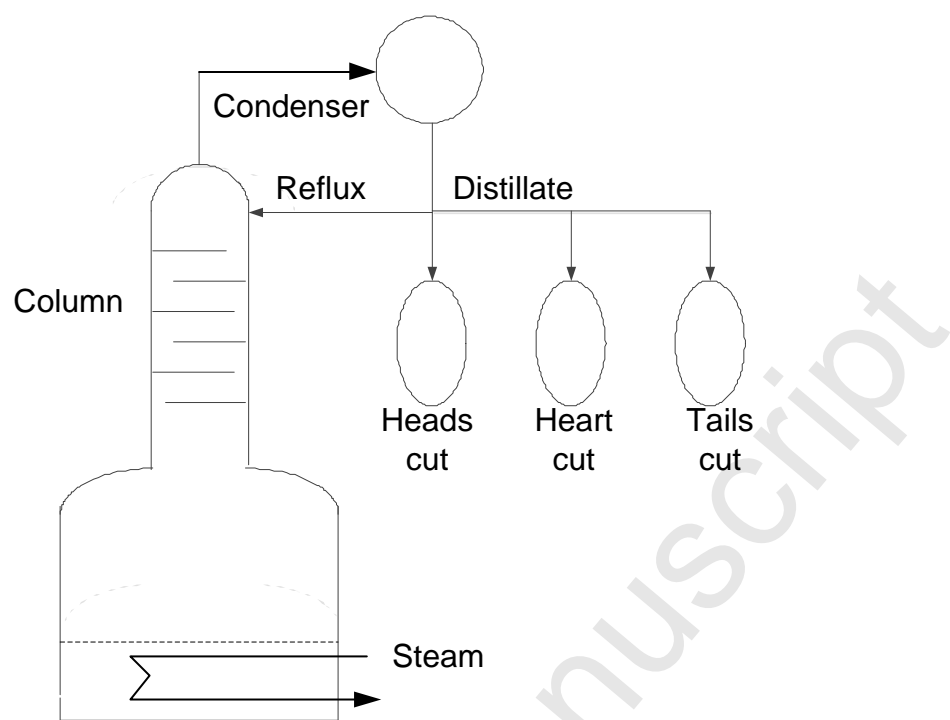

Fig. 6 - Scheme of the 72 hL orange spirit still.

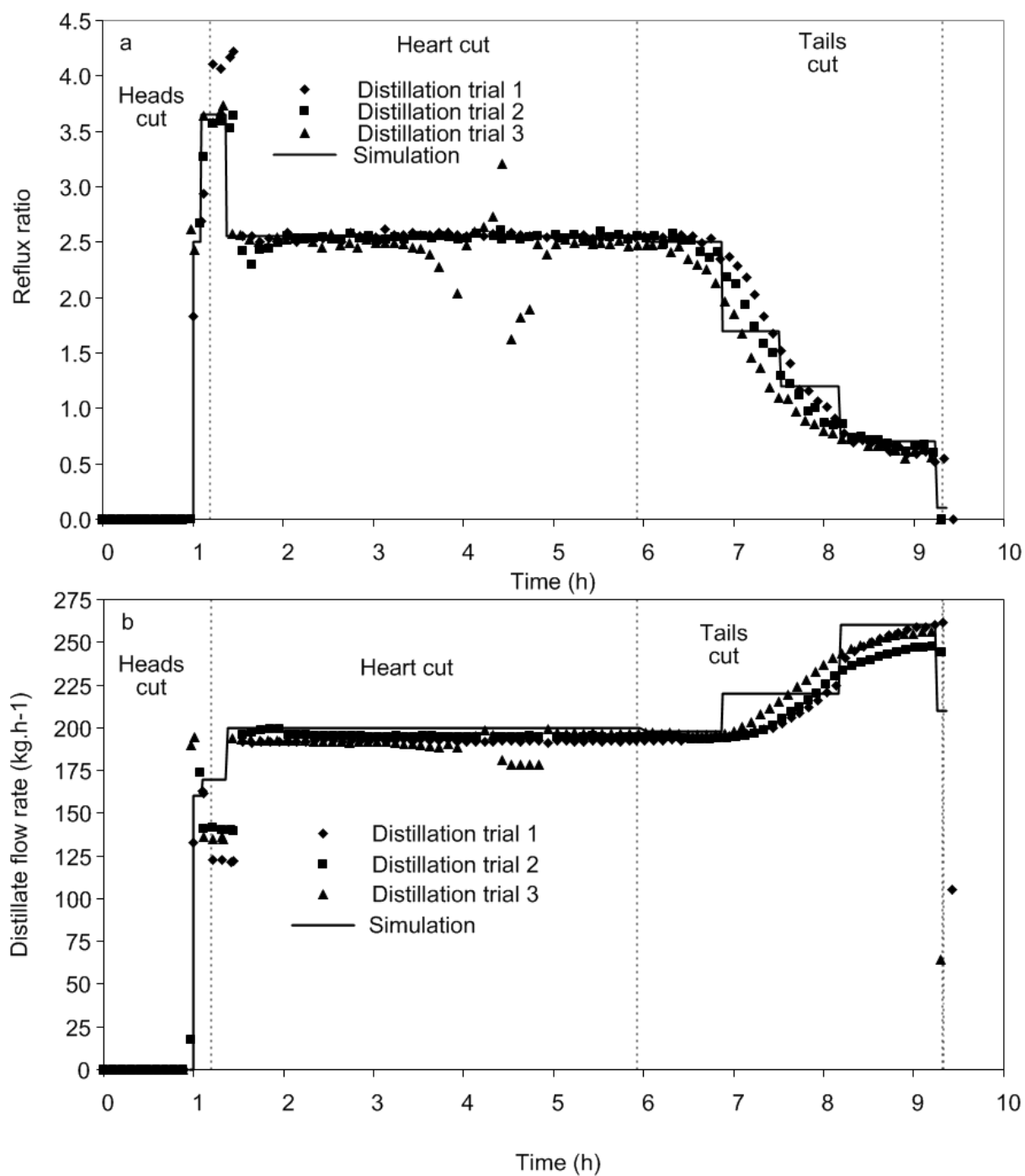

Fig.7 - Plot of (a) reflux ratio and (b) distillate flow rate as a function of time. Discrete data points represent plant data and solid lines represent simulation values.

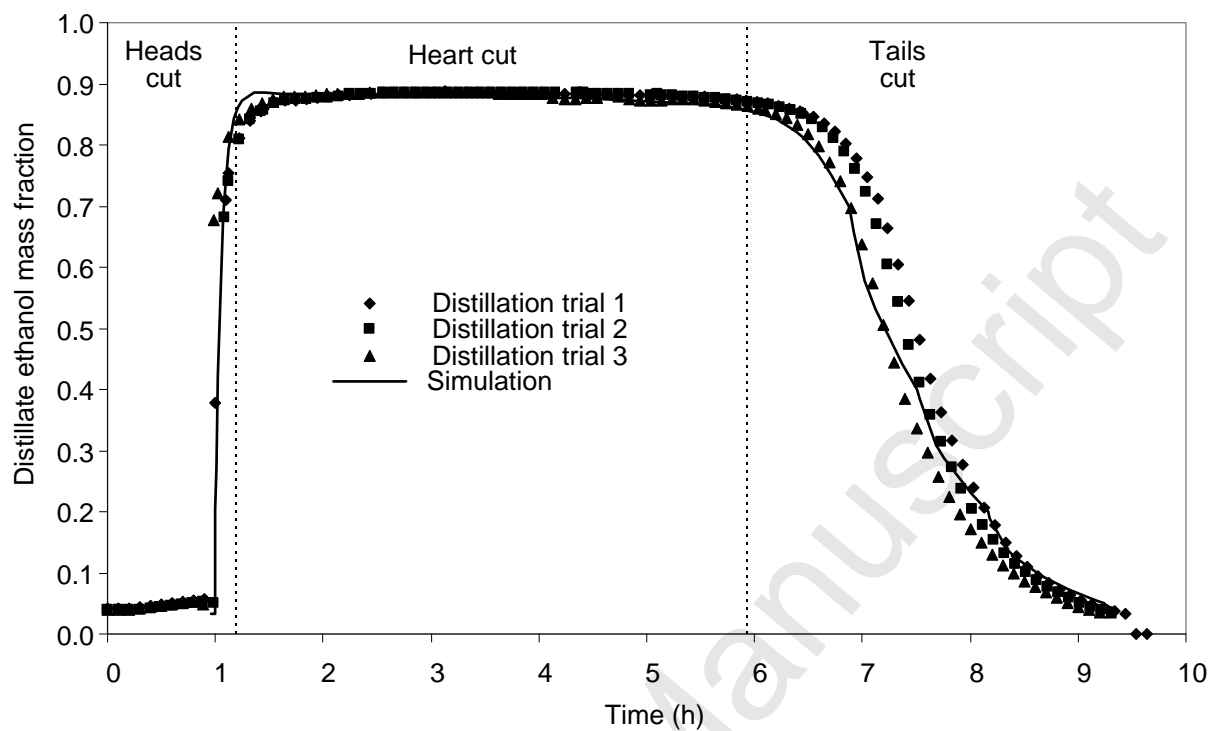

Fig.8 - Comparison of the change over time of distillate ethanol mass fractions in three trials (data points) vs. the simulation model (solid line). Dotted lines indicate separation of cuts by simulation.

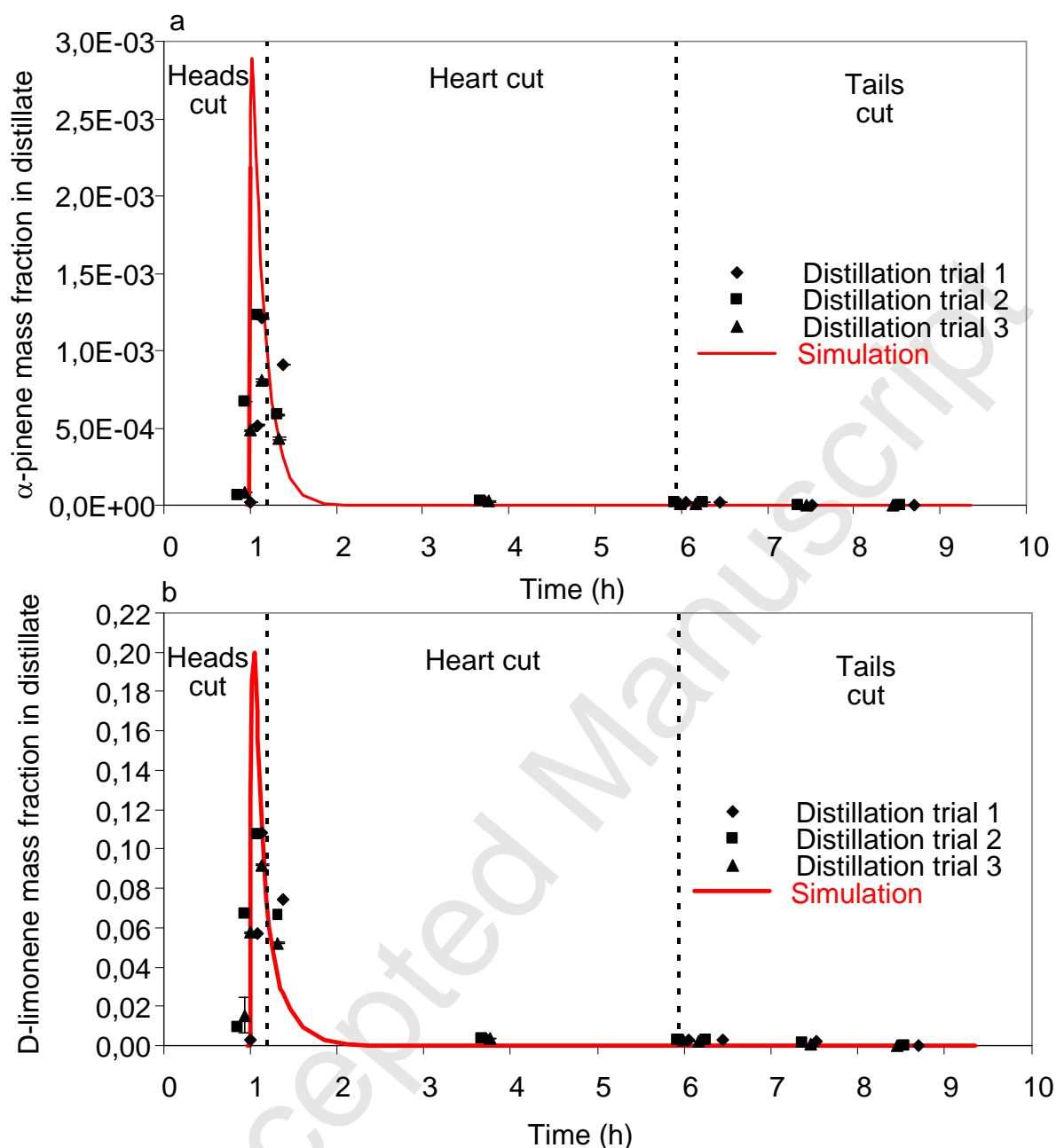

Fig. 9 - Comparisons of  $\alpha$ -pinene (a) and D-limonene (b) behaviours of three trials (data points) vs. the simulation model (solid line). Dotted lines indicate separation of cuts by simulation.

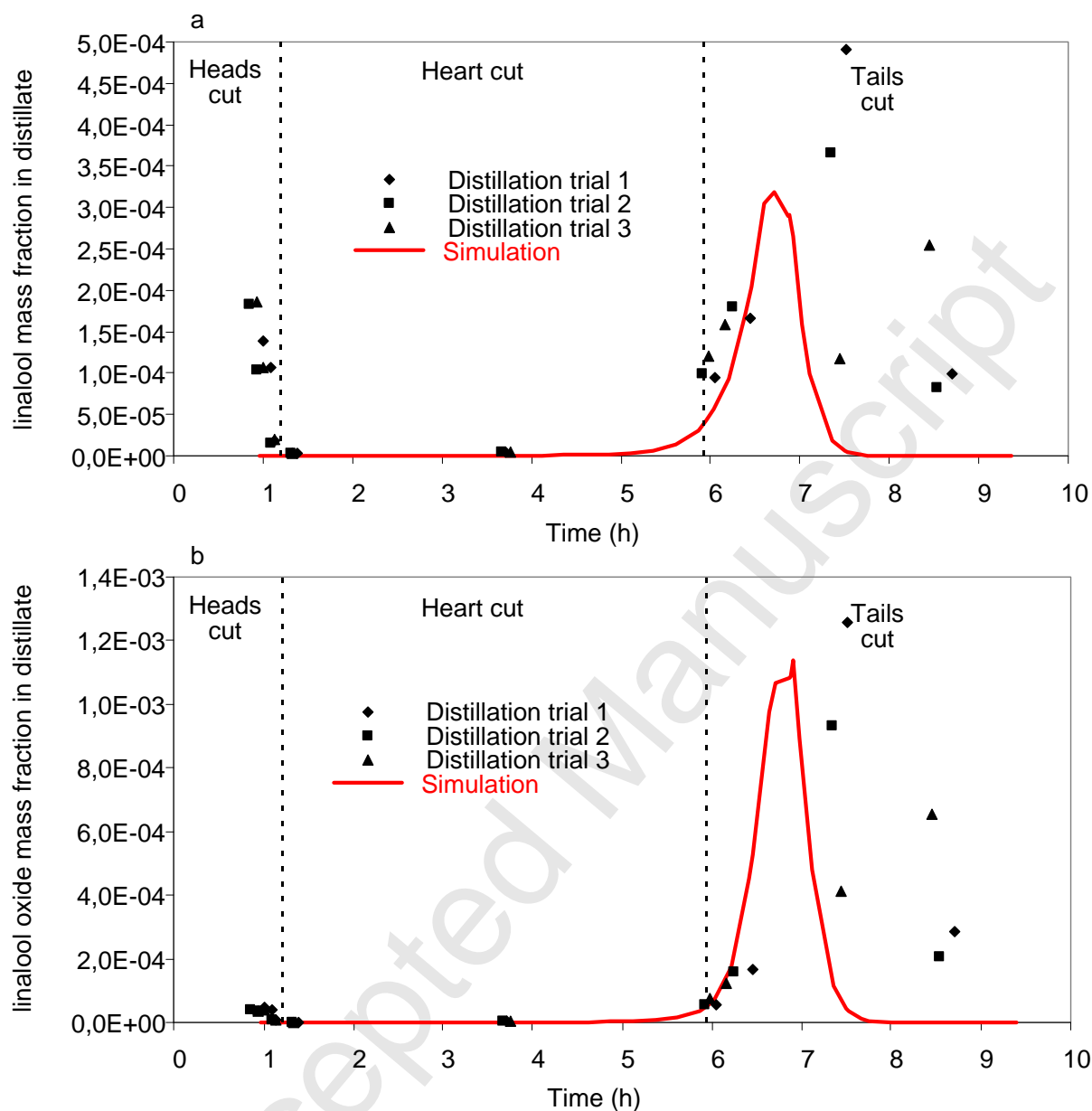

Fig. 10 - Comparisons of linalool (a) and linalool oxide (b) behaviours of three trials (data points) vs. simulation model (solid line). Dotted lines indicate separation of cuts by simulation.